

## A0852051 Havana Ribbon WW-60-72 24V

### Technical specifications:

LED system: 300x 0.19W extra warm-white LED (5050) 3000K  
 View angle: 120°  
 Light output: 898Lm/mtr  
 Power consumption: 5mtr max. 66W  
 1mtr max. 13.2W ±10%/M  
 Strip: IP20  
 Cutting length: 10cm (6 LED's) = 1.32W  
 Working temperature: -20°C until +50° C  
 Backside: Self adhesive 3M tape

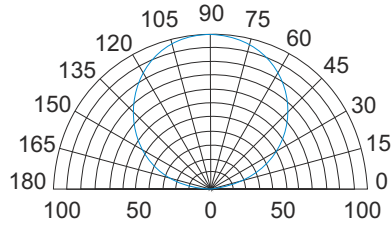

Relative luminous distribution



The Havana Ribbon should not be used in hot places  
 The best heat dissipation is to mount the Ribbon on an aluminum strip or Arctea Alu-Pro Profile. Ensure a proper heat dissipation

0.09	24V DC	Class III	IP20	F mark	Light-output / meter 898Lm	120° symm. LED-lens	mm L 5000 X W 10 X H 2.6
------	--------	-----------	------	--------	-------------------------------	---------------------------	-----------------------------------

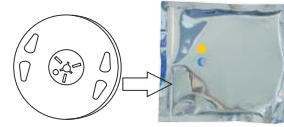

5 meter Havana Dropper is packed on reel, in anti-static bag

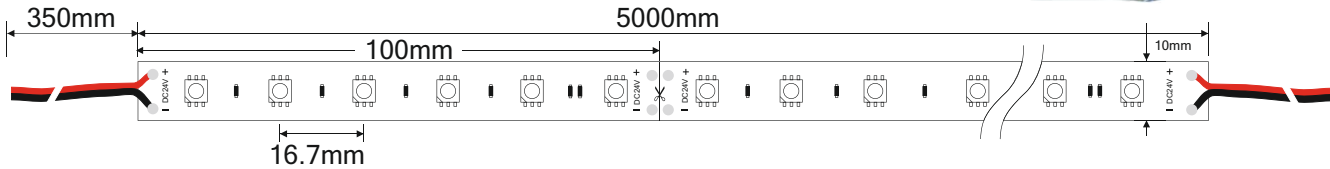

<p>Advised 8 ch. DMX controller:</p> <p><b>A9915063</b> Domotion ART-8D white included IR remote control</p> <ul style="list-style-type: none"> <li>• 8 DMX channels</li> <li>• 8 programmable scenes</li> <li>• Masterdim</li> <li>• Switch-Fade-Off-time 1-8 sec.</li> <li>• Scene to Scene fade 1-8 sec.</li> </ul>	<p>Dimensions in mm</p>	<p>Advised 8 ch. DMX controller:</p> <p><b>A9915062</b> Domotion ART-8D black included IR remote control</p> <ul style="list-style-type: none"> <li>• 8 DMX channels</li> <li>• 8 programmable scenes</li> <li>• Masterdim</li> <li>• Switch-Fade-Off-time 1-8 sec.</li> <li>• Scene to Scene fade 1-8 sec.</li> </ul>	<p>Dimensions in mm</p>
--	-------------------------	--	-------------------------

Advised 24V DC LED powersupply:

**A9900362** DC 24V 96W  
 (load max. 1x 5m A0852051)  
 Dimensions: 200x71x35mm  
 Weight: 0.52 Kg

IP65

Advised DMX PWM Dimmer:

**A9915016** 1 channel PWM Dimmer  
 max. load 24V/4A = 96W  
 Load max. 1x 5m A0852051  
 Dimensions: 90x40x20mm  
 weight: 0.05Kg

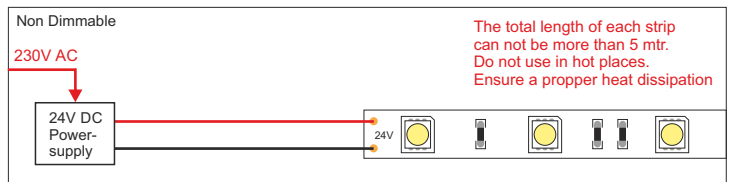
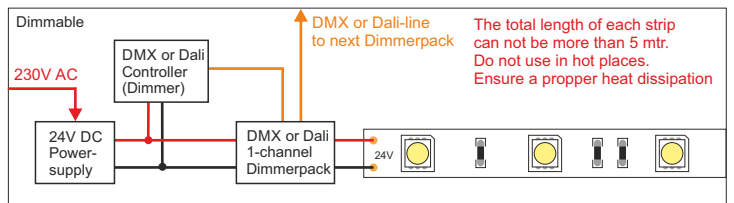
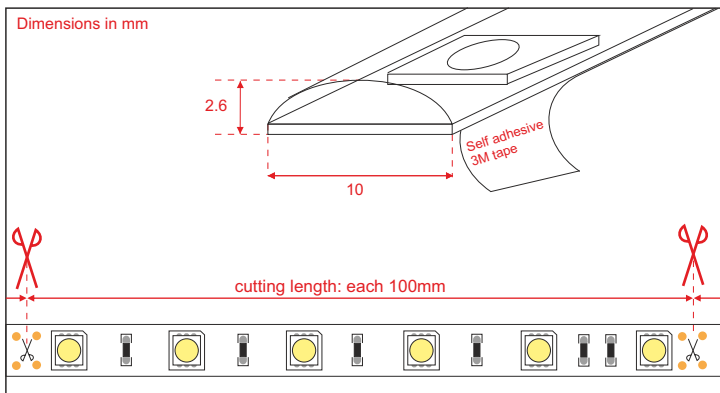

## A. Dimmable

A9915094 ART-8D DMX-512 Controller  
8 DMX-Channels & 8 Programable scenes  
Included IR remote control  
(without using the built-in Dimmerpack)

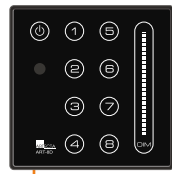

A9930004 Attema U50 Wallbox  
(not included)

Wallbox-Powersupply  
(not included)  
A9900030 PSU-12 12VDC  
or  
A9900031 PSU-24 24VDC  
Dimensions: Ø53 x 29.3 mm

DMX-line

24V DC

24V DC

DMX-line to next  
Dimmerpack

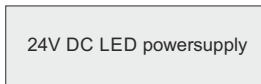

A9915016 Domotion  
1 ch. DMX PWM-Dimmerpack  
max. total load 24V/4A = 96W

5 mtr. (one chain) Havana Ribbon WW-60 contents 300 LED's (= 72W)  
Load max. 1x 5 meter Havana Ribbon WW-60 (= 72W)  
to Domotion 1-ch. DMX-512 PWM Dimmerpack  
and keep 24V DC cables short as possible (see Notes)  
(max 24V DC cable length (see page 3-7))

230V AC

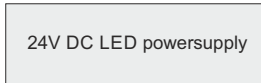

A9915016 Domotion  
1 ch. DMX PWM-Dimmerpack  
max. total load 24V/4A = 96W

5 mtr. (one chain) Havana Ribbon WW-60 contents 300 LED's (= 72W)  
Load max. 1x 5 meter Havana Ribbon WW-60 (= 72W)  
to Domotion 1-ch. DMX-512 PWM Dimmerpack  
and keep 24V DC cables short as possible (see Notes)  
(max 24V DC cable length (see page 3-7))

230V AC

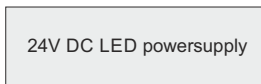

A9915016 Domotion  
1 ch. DMX PWM-Dimmerpack  
max. total load 24V/4A = 96W

5 mtr. (one chain) Havana Ribbon WW-60 contents 300 LED's (= 72W)  
Load max. 1x 5 meter Havana Ribbon WW-60 (= 72W)  
to Domotion 1-ch. DMX-512 PWM Dimmerpack  
and keep 24V DC cables short as possible (see Notes)  
(max 24V DC cable length (see page 3-7))

230V AC

## B. Non Dimmable



5 mtr. (one chain) Havana Ribbon WW-60 contents 300 LED's (= 72W)  
Load max. 1x 5 meter Havana Ribbon WW-60 (= 72W)  
to Domotion 1-ch. DMX-512 PWM Dimmerpack  
and keep 24V DC cables short as possible (see Notes)  
(max 24V DC cable length (see page 3-7))

### Notes:

#### UK

The thickness of the 24V DC cable depends on the total cable length and total power consumption of all connected fixtures. (See page 3)

#### NL

De diameter van de 24V DC-kabel is afhankelijk van de totale lengte van de kabel en het totale stroomverbruik van alle verbonden toestellen. (zie tabel op pagina 4)

#### D

Der Durchmesser des 24V DC-Kabels hängt von der Gesamtlänge des Kabels und der gesamten Leistungsaufnahme aller angeschlossenen Geräte ab. (Siehe Tabelle auf Seite 5)

#### FR

Le diamètre du câble d'alimentation 24V DC dépend de la longueur totale du câble et la consommation électrique totale de tous les périphériques connectés. (voir page 6)

#### ES

La sección del cable de 24V DC depende de la longitud total del cable y el consumo de energía total de todas las luminarias (véase la página 7)

#### IT

Il diametro del cavo 24V DC dipende dalla lunghezza totale del cavo e il consumo di energia totale di tutti apparecchi collegati.

Recommended cable conductor surface (mm<sup>2</sup>) with cable lengths of 1-50 meters. for parallel connected 24 volt LED fixtures.

Note; This table is an obligation and not a binding opinion. If necessary, make a electrical resistance calculation ( $Pouillet A \times R = p \times l$ )

24 Volt		Cable inner conductor 1.5mm <sup>2</sup>					Cable inner conductor 2.5mm <sup>2</sup>					Cable inner conductor 4mm <sup>2</sup>				
		Watt	24	48	72	96	120	144	168	192	216	240	264	288	312	336
Kabel- lengte (m)	Ampere	1	2	3	4	5	6	7	8	9	10	11	12	13	14	15
	1															
2																
3																
4																
5																
6																
7																
8																
9																
10																
11																
12																
13																
14																
15																
16																
17																
18																
19																
20																
21																
22																
23																
24																
25																
26																
27																
28																
29																
30																
31																
32																
33																
34																
35																
36																
37																
38																
39																
40																
41																
42																
43																
44																
45																
46																
47																
48																
49																
50																

- As much as possible shortest path for the 12V cables
- Branching cables without interrupting the main cable
- Transformer must be placed in centre of the connected fixtures
- Polarity: positive (+) = red or brown, minus (-) = black or blue
- Transformer-capacity 25% greater than the sum of conected fixtures

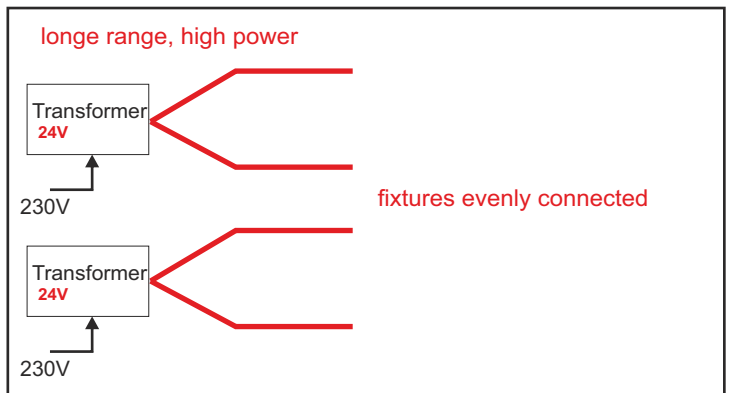
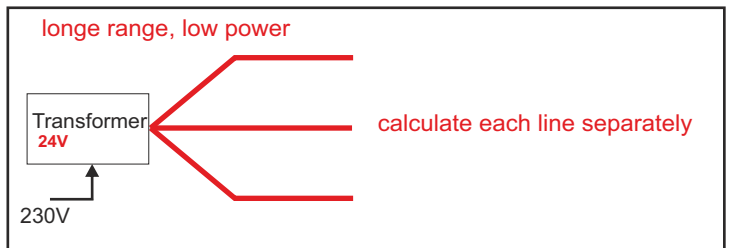
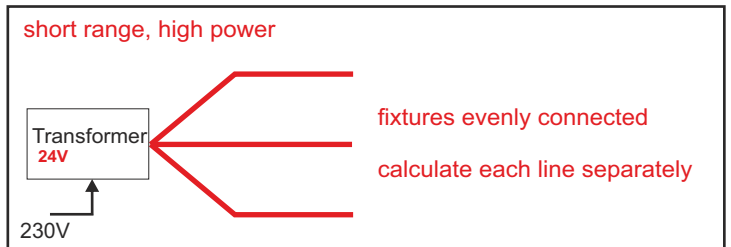
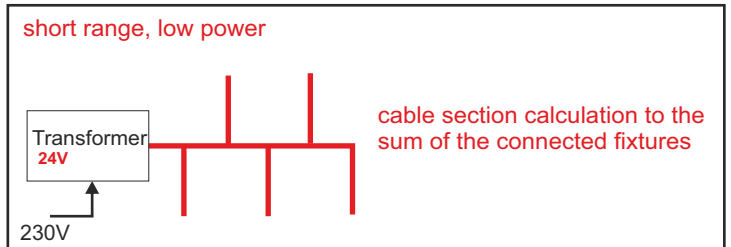

# Geadviseerd kabelgeleider-oppervlak (mm<sup>2</sup>) bij kabellengtes van 1-50 mtr. voor 24 Volt parallel aangesloten LED armaturen.

Note; Deze tabel is een vrijblijvend en geen dwingend advies. Maak indien nodig een berekening van elektrische weerstand en geleidbaarheid met de wet van Pouillet ( $A \times R = p \times l$ )

24 Volt	Kabelgeleider 1.5mm <sup>2</sup>					Kabelgeleider 2.5mm <sup>2</sup>					Kabelgeleider 4mm <sup>2</sup>				
	Watt	24	48	72	96	120	144	168	192	216	240	264	288	312	336
Kabel-lengte (m) \ Ampere	1	2	3	4	5	6	7	8	9	10	11	12	13	14	15
1															
2															
3															
4															
5															
6															
7															
8															
9															
10															
11															
12															
13															
14															
15															
16															
17															
18															
19															
20															
21															
22															
23															
24															
25															
26															
27															
28															
29															
30															
31															
32															
33															
34															
35															
36															
37															
38															
39															
40															
41															
42															
43															
44															
45															
46															
47															
48															
49															
50															

- Zoveel mogelijk kortste weg voor de 24V kabels
- Kabels aftakken zonder de hoofdkabel te onderbreken
- Trafo mogelijk in het midden plaatsen
- Polariteit: plus(+) = rood of bruin, min(-) = zwart of blauw
- Trafo-capaciteit 25% hoger kiezen dan de som der belastingen

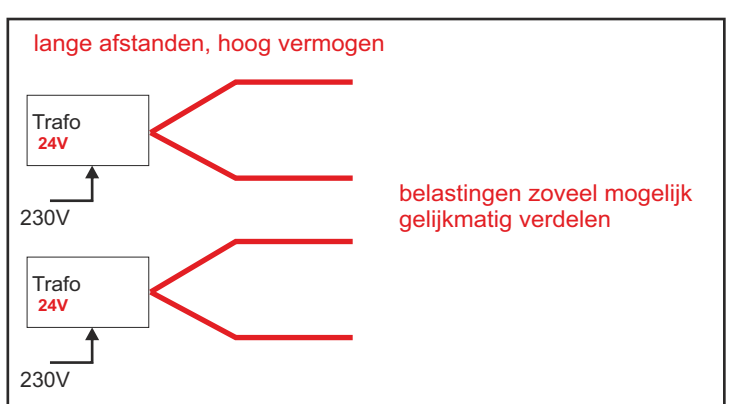
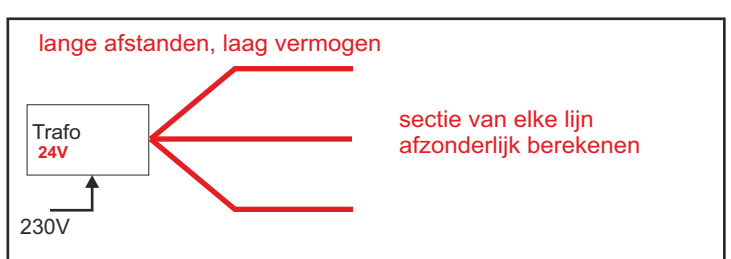
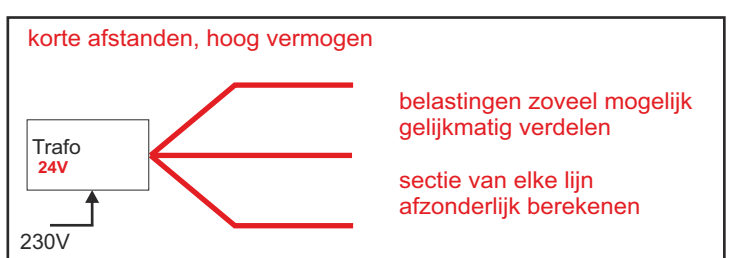
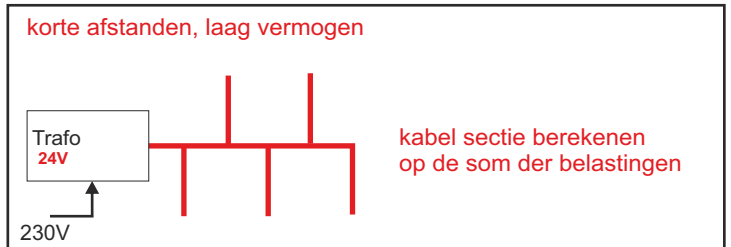

# Empfohlener Querschnitt vom Kabelinnenleiter in mm<sup>2</sup> bei Kabellängen von 1-50 Meter für parallel geschaltete 24-Volt-LED-Leuchten.

Bitte beachten: Diese Tabelle ist eine unverbindliche Beratung. Falls erforderlich, eine Berechnung vom elektrischen Widerstand und Leitfähigkeit mit der Formel von Pouillet machen

24 Volt		Kabelinnenleiter 1.5mm <sup>2</sup>					Kabelinnenleiter 2.5mm <sup>2</sup>					Kabelinnenleiter 4mm <sup>2</sup>				
		24	48	72	96	120	144	168	192	216	240	264	288	312	336	360
Kabel- länge (m)	Ampere	1	2	3	4	5	6	7	8	9	10	11	12	13	14	15
	1															
2																
3																
4																
5																
6																
7																
8																
9																
10																
11																
12																
13																
14																
15																
16																
17																
18																
19																
20																
21																
22																
23																
24																
25																
26																
27																
28																
29																
30																
31																
32																
33																
34																
35																
36																
37																
38																
39																
40																
41																
42																
43																
44																
45																
46																
47																
48																
49																
50																

- So viel wie möglich dem kürzesten Weg für die 24V-Leitungen
- Kabel abzweigen ohne Unterbrechung der Hauptleitung
- Trafo wenn möglich in der Mitte montieren
- Polarität: positiv(+) = rot oder braun, minus(-) = schwarz oder blau
- Trafo-Kapazität immer 25% größer wählen als die Summe der Last

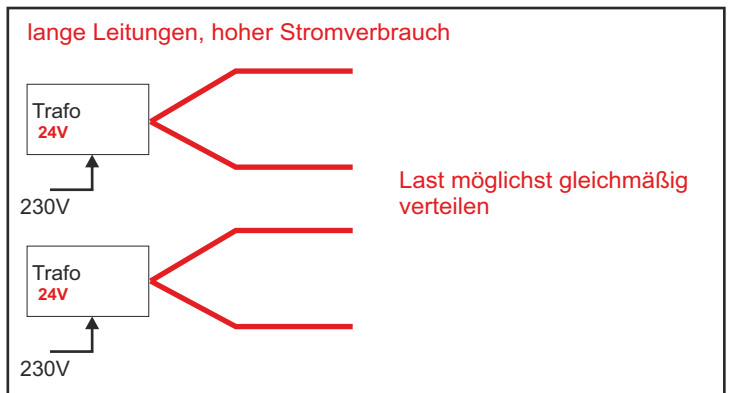
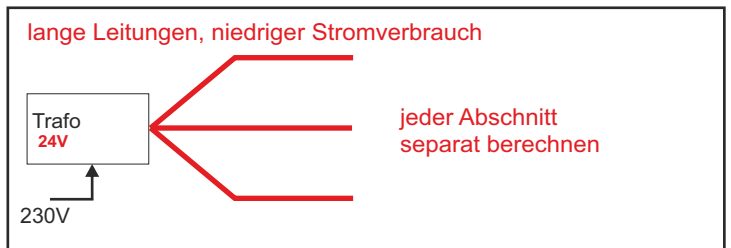
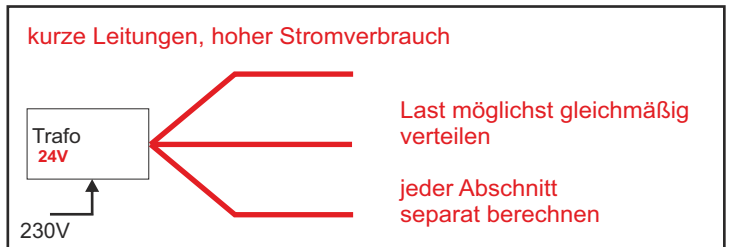
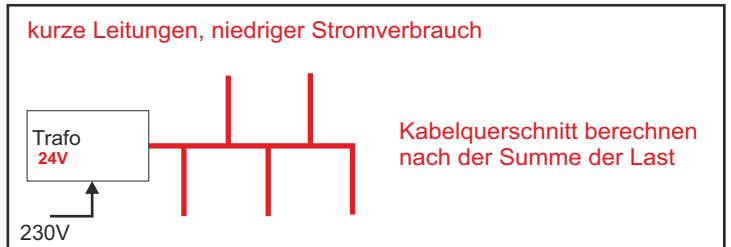

Surface recommandée conducteur de câble (mm<sup>2</sup>) 1-50 m longueurs de câble. connectés en parallèle pour 24 volts luminaires à LED.

Remarque, Ce tableau est un des conseils informels et non contraignants. Si nécessaire, un calcul de résistance électrique et la conductivité avec la loi de Pouillet ( $A \times R = p \times l$ )

24 Volts		Conducteur de câble 1.5mm <sup>2</sup>					Conducteur de câble 2.5mm <sup>2</sup>					Conducteur de câble 4mm <sup>2</sup>				
		24	48	72	96	120	144	168	192	216	240	264	288	312	336	360
Kabel- länge (m)	Ampere	1	2	3	4	5	6	7	8	9	10	11	12	13	14	15
	1															
2																
3																
4																
5																
6																
7																
8																
9																
10																
11																
12																
13																
14																
15																
16																
17																
18																
19																
20																
21																
22																
23																
24																
25																
26																
27																
28																
29																
30																
31																
32																
33																
34																
35																
36																
37																
38																
39																
40																
41																
42																
43																
44																
45																
46																
47																
48																
49																
50																

- Choisir le chemin le plus court pour les câbles 24V
- Éclaircie câbles sans interrompre le câble principal
- Transformer peut être centrée
- Polarité: positive (+) = rouge ou brun, moins (-) = noir ou bleu
- Transformateur-capacité de 25% de plus que de choisir la charge
- LED-lampes Parallèlement interrupteur

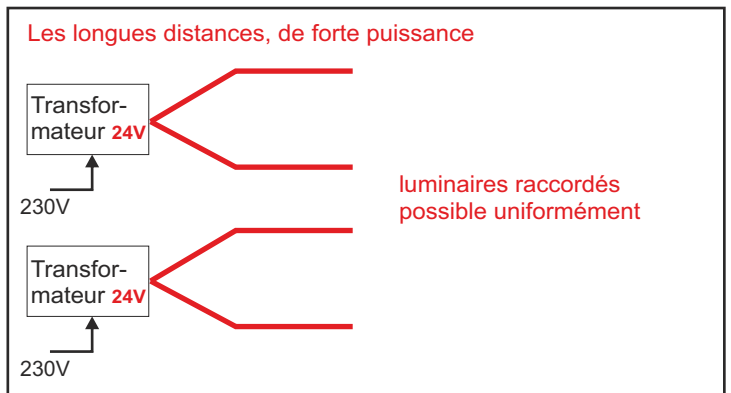
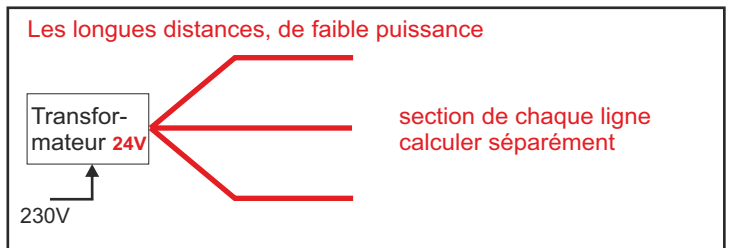
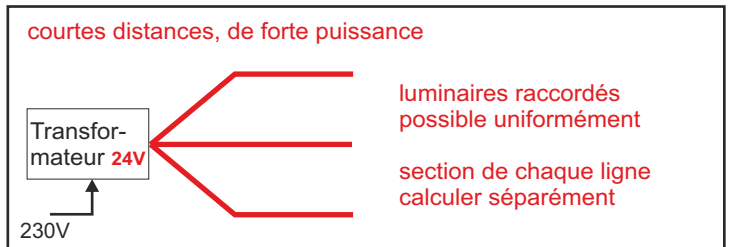
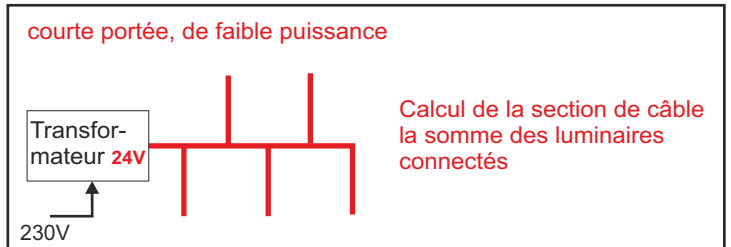

# Sección de cable recomendada en mm<sup>2</sup> con longitudes de cable 1-50 metros. para conectar en paralelo de 24 voltios LED fixtures.

Note; Este cuadro es un consejo informal y no vinculante. Si es necesario, un cálculo de resistencia eléctrica y la conductividad con la ley de Pouillet ( $A \times R = p \times l$ )

24 Voltios	Sección de cable 1.5mm <sup>2</sup>					Sección de cable 2.5mm <sup>2</sup>					Sección de cable 4mm <sup>2</sup>					
	Watt	24	48	72	96	120	144	168	192	216	240	264	288	312	336	360
Kabel- lengte (m)	Ampere	1	2	3	4	5	6	7	8	9	10	11	12	13	14	15
1																
2																
3																
4																
5																
6																
7																
8																
9																
10																
11																
12																
13																
14																
15																
16																
17																
18																
19																
20																
21																
22																
23																
24																
25																
26																
27																
28																
29																
30																
31																
32																
33																
34																
35																
36																
37																
38																
39																
40																
41																
42																
43																
44																
45																
46																
47																
48																
49																
50																

Intente utilizar la mínima distancia de cable en líneas de 12V.

Intente utilizar una línea principal sin cortarlo y sacar de él derivaciones individuales

Si es posible coloque la fuente de alimentación en el centro de la línea [principal de distribución]

Polaridad: positivo (+) = rojo o marrón, negativo (-) = negro o azul

La fuente de alimentación debe ser 25% mayor que la suma de las luminarias a conectar

### distancias cortas, de baja potencia

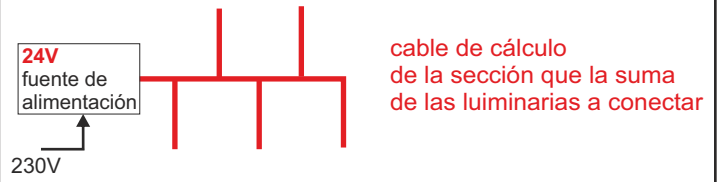

### distancias cortas, de alta potencia

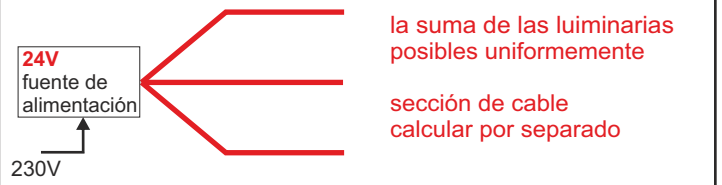

### distancias largas, de baja potencia

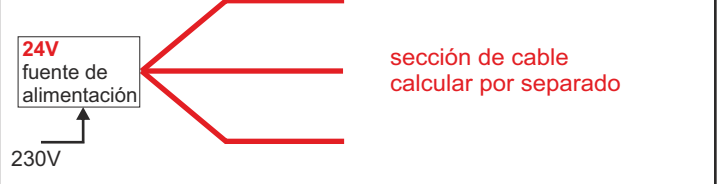

### distancias largas, de alta potencia

