



SYSTEM ONE

User Guide

English

Table of Contents

Introduction.....	4	Performing	24
Support.....	4	Loading Tracks	24
Product Registration	4	Searching & Filtering Tracks	26
		Match	27
Setup	5	Editing Playlists	28
Platter Assembly.....	5	Playlist Deck.....	29
Software Setup	6	Playback & Cueing.....	30
For Use with Engine DJ (Standalone Preparation)	6	Looping & Beat-Jumping	31
Devices & File Analysis.....	6	Syncing & Pitch Adjustment	32
Installing an Internal Drive.....	7	Beat Grid Editing.....	33
For Use with Serato DJ Pro	8	Pad Modes	34
		Hot Cue Mode	34
		Pitch Play Mode.....	34
		Roll Mode.....	35
		Loop Mode.....	35
		Sampler Mode	36
		Scratch Bank Mode	36
		Stems Mode	37
		Slicer Mode	37
Features	9	FX	38
Top Panel.....	9	BPM FX	38
Navigation Controls.....	9	Sweep FX	39
Mixer Controls.....	10	Fader FX.....	40
Deck Controls	11	Touch FX.....	41
Pad, Loop, and Stem Controls	13	Mixer.....	42
FX Controls	14	Record.....	44
Front Panel	15		
Rear Panel	16	Control Center	45
Operation	17	Parameters	45
Touchscreen Overview	17	Layout.....	46
Performance View.....	17	Profile.....	47
Track Overview & Waveform.....	17	Settings.....	50
Performance Library.....	19		
Toolbar.....	20		
Library View	21		

Source.....	52
Engine Remote Library	53
Wi-Fi.....	54
Bluetooth®	55
Engine Lighting.....	56
Preferences	57
Appendix	58
FX Parameters	58
BPM FX.....	58
Touch FX.....	65
Technical Specifications	67
Trademarks & Licenses	71

Introduction

Thank you for purchasing your Rane SYSTEM ONE! At Rane, performance and reliability mean as much to us as they do to you. That's why we design our equipment with only one thing in mind—to make your performance the best it can be. We're honored and excited to play a part in your musical & creative DJ journey!

Support

For the latest information about this product (such as documentation, technical specifications, system requirements, compatibility information, etc.), visit [rane.com](https://www.rane.com).

For additional hardware support, visit support.rane.com.

For additional software support for Engine DJ, visit support.enginedj.com.

For additional software support for Serato DJ Pro, visit support.serato.com.

Product Registration

Your product may include exclusive software and/or promotions which can only be accessed by registering your new product.

To check eligibility and access the available content, please register your product by following the instructions below:

1. Visit [rane.com](https://www.rane.com) and click **Account**. Alternatively, go directly to profile.inmusicbrands.com.
2. Click **Sign In** to access your existing account, or create a new account.
3. Once signed in, click **Register New Product**.
4. Enter the product serial number into the box and click **Check Serial**.
5. Complete the form and click **Register Your Product**.
6. Upon successful registration, any applicable software downloads, exclusive content, and promotional offers will be shown in your account.

Note: You can also automatically register your product to your inMusic Brands Profile when you connect to your Engine DJ profile after turning on SYSTEM ONE. See the following [Software Setup > For Use with Engine DJ \(Standalone Preparation\)](#) for more information.

Setup

Platter Assembly

1. Remove the SYSTEM ONE base from the packaging and place on a flat, stable surface for assembly.
2. Remove the platter assemblies from the package.
3. Place the platters onto each deck of the SYSTEM ONE base by aligning the pins in the bottom of the platter with the holes in SYSTEM ONE's motor. Press it down firmly. Check to make sure that it rotates uniformly and does not wobble excessively.

Note: If you would like to adjust the slip friction of the disc, consider placing 1-4 of the included scratch washers over the spindle, underneath the slipmat. The more you elevate the **Control Disc** with the washers, the more spinback you will get.

4. Place the slipmat onto the platter. Then place the **Control Disc** over the spindle (with the attached **Quick Release Adapter** on top).

To lock the **Control Disc** to the spindle, pinch the top of the spindle while slowly rotating the disc until you hear it click. It locks when the groove in the spindle lines up directly opposite to the button on the side of the **Quick Release Adapter**.

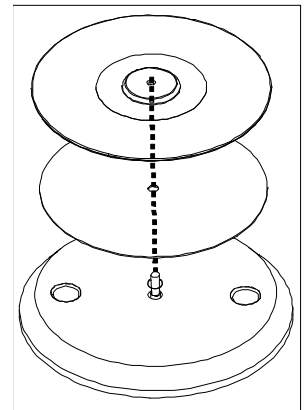
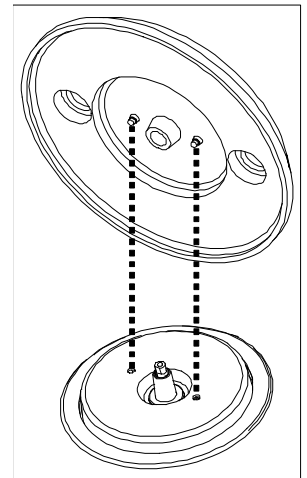

Software Setup

For Use with Engine DJ (Standalone Preparation)

1. Download and install the Engine DJ desktop software at enginedj.com/downloads.
2. Import music into the Engine DJ software to analyze it and prepare your music for stems, then export your music to your media device. See the following [Devices & File Analysis](#) section for more information, and consult the Engine DJ software User Guide.
3. Place SYSTEM ONE on a flat, stable surface.
4. While the power is switched off, plug the included power cable into SYSTEM ONE first, then plug the cable into a power outlet.
5. Power on SYSTEM ONE using the **power button**.
6. During startup, you will first be presented with a Wi-Fi connection menu to connect to your local network.
After the initial setup, you can dismiss this screen each time, or set it to not show again at startup. You can also adjust your connection settings at any time using the [Wi-Fi](#) menu in the Control Center.
7. Once connected to the internet, follow the on-screen prompts to update to the latest firmware (if available). Firmware can also be downloaded from enginedj.com/downloads. When the firmware update is complete, SYSTEM ONE will restart.
8. Next, you will be prompted to connect to your Engine DJ profile. With your Engine DJ profile, you can register your device, connect streaming and cloud services so you can log into each with a single Engine DJ profile login, and access crowd-sourced streaming metadata and beat grid information. You can use a mobile device to scan the QR code, or visit device.enginedj.com and enter the code shown.
You can also dismiss this screen each time, or set it to not show again at startup. To log in to an Engine DJ profile at any other time, use the **Log In** button found in the [Profile](#) menu.
9. SYSTEM ONE has more settings that you can customize in the [Layout](#), [Profile](#), and [Settings](#) menus. See [Control Center](#) to learn about these settings.

Devices & File Analysis

In standalone operation, SYSTEM ONE can play music files from physical media such as USB drives, SD cards, or a drive connected to the Internal HD bay (as well as from streaming and cloud services). Make sure you are using only the supported file systems (for USB drives, SD cards, and the internal drive) and file formats (for music files) listed below.

Supported file systems: exFAT (recommended), FAT32

Supported file formats: AAC/M4A	MP3 (32–320 kbps)
AIF/AIFF (44.1–192 kHz, 16–32-bit)	MP4
ALAC	Ogg Vorbis
FLAC	WAV (44.1–192 kHz, 16–32-bit)

Although SYSTEM ONE can play tracks that have not been analyzed yet, pre-analyzing them allows its features to work most effectively. You can analyze tracks in two ways:

- **On SYSTEM ONE, load the track:** When you load a track to play, SYSTEM ONE will automatically analyze it (if it has not already been analyzed). This may take a moment to complete, depending on the length of the track. You can start playing the track from the beginning **immediately**, though you will need to wait a moment for the analysis to finish.
- **Use Engine DJ software:** The included Engine DJ software can pre-analyze your music library for use with SYSTEM ONE. You can also use it to organize your library by creating playlists. It also manages your hardware preferences (see [Operation](#) to learn more about this).

Visit enginedj.com/downloads to download the Engine DJ software.

Installing an Internal Drive

To create internal storage space on SYSTEM ONE, you can purchase a **SATA** (Serial ATA) drive and install it yourself, but read this chapter first.

SYSTEM ONE can support nearly any standard 2.5" (63.5 mm) form factor SATA drive on the market. A solid-state drive (SSD) is highly recommended for the best performance, especially when using Stems, but you can also use a hard-disk drive (HDD). Drives should be formatted to an **exFAT** file system prior to installation for best results.

Note: Alternatively, you could install an **mSATA** (mini-SATA) drive, but make sure you also purchase an adapter that enables it to fit into a typical 2.5" SATA interface.

1. Make sure SYSTEM ONE is powered **off** and unplugged, and place it upside-down on a soft, flat surface.
2. Locate the **Internal HD panel** in the center of the bottom panel of SYSTEM ONE. Use a Phillips-head screwdriver to remove the screws (don't lose them!), and remove the drive panel.
3. Gently pull out the red **SATA connector and cable** from inside your SYSTEM ONE. Be careful not to disturb anything inside—handle just the SATA connector and cable.
4. Connect your **SATA drive** to the **SATA connector**. Make sure the connection is secure.
5. Use four **3x5 mm mounting screws** (included with SYSTEM ONE or with your SATA drive) to secure the SATA drive to the drive panel. Do not overtighten the screws, but make sure the drive is secure and does not shake.
6. Place the drive panel back onto the bottom panel of SYSTEM ONE, and use the original screws to secure it in place.

You can now access this drive while using SYSTEM ONE. To transfer files to your internal drive from a connected computer, follow these steps:

1. Connect the included USB-C cable from the **USB To Computer** port on the rear panel of SYSTEM ONE to an available USB port on your computer.
2. With SYSTEM ONE powered on, press the **Source/▲** button above the touchscreen.
3. Tap the **computer icon** next to your internal drive name in the list of sources.
4. In the **Access Device Storage** window that appears, tap **Continue** to stop track playback and safely eject the internal drive from SYSTEM ONE. It will then proceed with mounting the drive to your connected computer. This process may take a few seconds.

Note: While in Device Storage mode, SYSTEM ONE is not available for playback.

5. Once mounting is complete, the drive will appear as an external drive on your computer. You can now use Engine DJ to transfer analyzed music to it, or transfer files directly from your file browser.
6. To exit Device Storage mode, first safely eject the internal drive from your computer. Then, tap **Exit Mode** on the SYSTEM ONE touchscreen. The unit will restart and the internal drive will be available to select as a source.

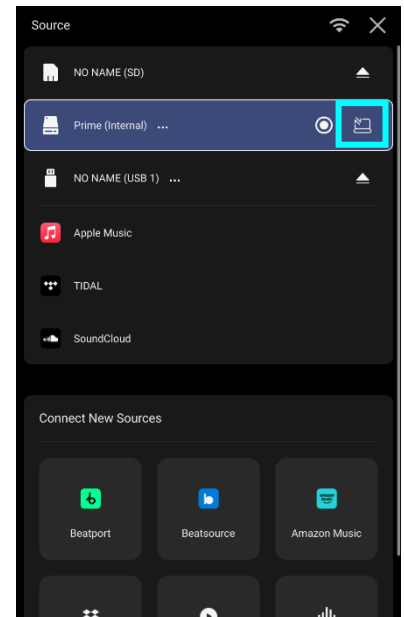

IMPORTANT: If your internal drive has not been formatted prior to installation, you will see an option titled **Setup Internal Drive** in the **Connect New Sources** section of the Source menu. Select this option to enter Device Storage mode, where you can format your device to an exFAT file system. Scan the QR code shown on your touchscreen for additional help with setting up your drive.

See the [Devices & File Analysis](#) section to learn more about supported files and file systems, or see the [Source](#) section to learn more about selecting your internal drive as the active source.

For Use with Serato DJ Pro

1. Make sure you have downloaded and installed the latest Serato DJ Pro software at serato.com/dj/pro/downloads.
2. Place SYSTEM ONE on a flat, stable surface.
3. While the power is switched off, plug the included power cable into SYSTEM ONE first, then plug the cable into a power outlet.
4. Power on SYSTEM ONE using the **power button**.
5. During startup, you will first be presented with a Wi-Fi connection menu to connect to your local network.
After the initial setup, you can dismiss this screen each time, or set it to not show again at startup. You can also adjust your connection settings at any time using the **Wi-Fi** menu in the Control Center.
6. Once connected to the internet, follow the on-screen prompts to update to the latest firmware. Firmware can also be downloaded from enginedj.com/downloads. When the firmware update is complete, SYSTEM ONE will restart.
7. Use the included USB-C cable to connect SYSTEM ONE from the **USB To Computer** port on the rear panel to an available USB port on your computer, or a powered hub connected to the computer.
8. Open Serato DJ Pro on your computer.
9. Use the **Source** menu to select Serato DJ as the active source.
10. Load tracks using the touchscreen, the **Scroll / Load** encoders, or directly from Serato DJ Pro on your computer.
There are additional Pad Modes that can be used exclusively with Serato DJ Pro, as well as control of Serato software effects from your SYSTEM ONE.

For more information on how to use Serato DJ Pro with the SYSTEM ONE, please visit support.serato.com.

Features

Top Panel

Navigation Controls

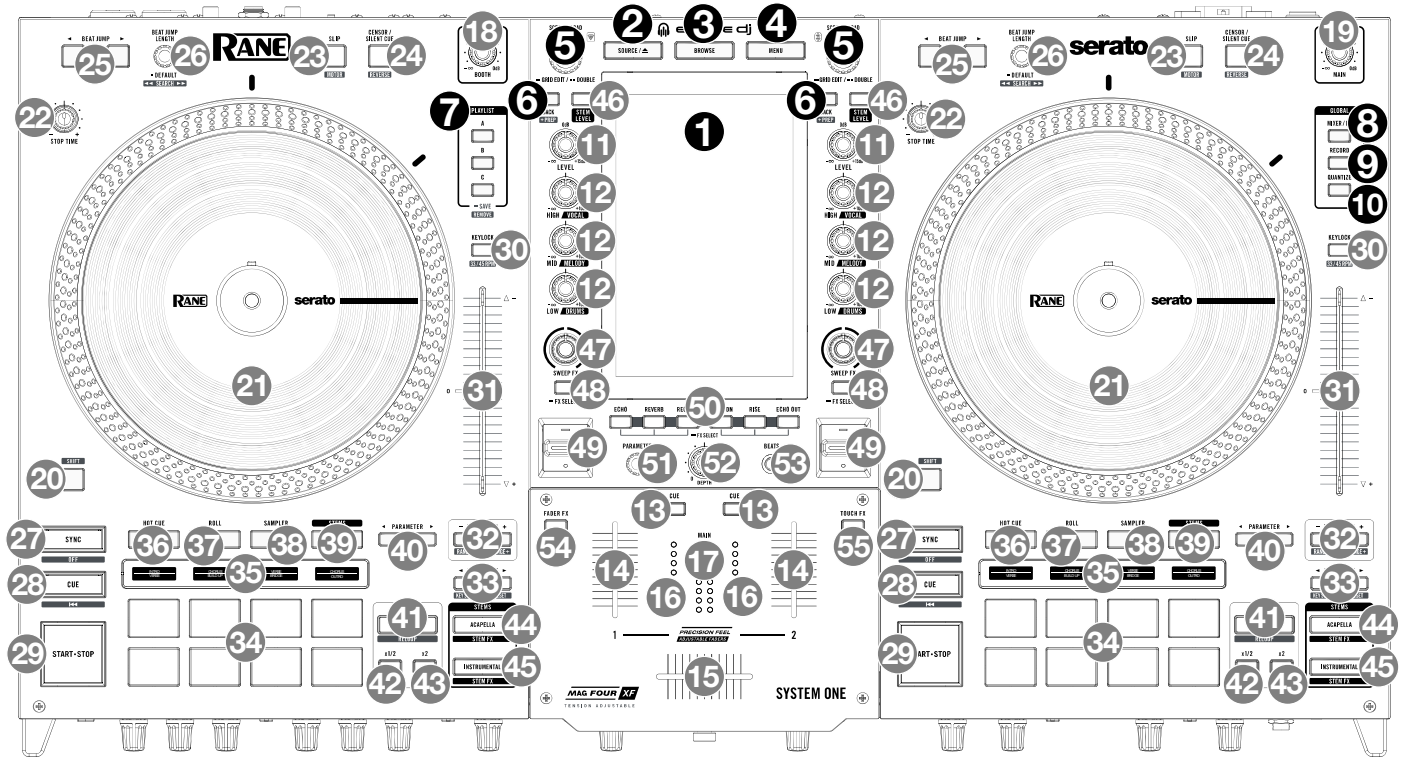

- 1. Touchscreen:** This full-color multi-touch display shows information relevant to SYSTEM ONE's current operation. Touch the touchscreen (and use the hardware controls) to control the SYSTEM ONE interface. See [Touchscreen Overview](#) for more information.
- 2. Source:** Press this button to open the [Source](#) menu, where you can view and select from available media devices and cloud sources. From this menu you can also eject connected media devices. To prevent data corruption, drives must be ejected before being removed from the player.
- 3. Browse:** Press this button to cycle between [Library View](#) and [Performance View](#).
- 4. Menu:** Press this button to open the [Control Center](#), which provides access to commonly used **Parameters** and includes quick links to other menus such as **Source**, **Wi-Fi**, **Bluetooth**, **Engine Lighting**, **Profile**, and **Settings**.
 In Performance View, hold **Shift** and press the **Menu** button to cycle between **View 1-3** layout presets, which can be customized in the [Layout](#) menu. In Library View, hold **Shift** and press the **Menu** button to open or close the collection panel while the track list is in focus.
- 5. Scroll / Load Knob:** In [Performance View](#), turn this knob to open [Library View](#) and navigate through lists.
Note: Alternatively, you can change the default **Encoder Behavior** for these knobs to adjust the waveform zoom level in the [Settings > Device](#) menu.
 Press these knobs to move forward in the touchscreen, select an item, or load a track to the selected deck.
 Press and hold **Shift** and then press these knobs to eject the selected track from the deck.
 Quickly double-press these knobs to instantly double the track from the opposing deck on the current deck.
 Press and hold these knobs to open the Beat Grid Editor for the selected deck. See [Beat Grid Editing](#) for more information.
- 6. Back / +Prep:** While in Library View, press this button to move to the previous window. While in Performance View, press this button to enter Library View.
 Press and hold **Shift** and press these buttons to load a track to the Prepare list.

7. **Playlist A/B/C / Remove:** While in **Library View**, press and hold these buttons to save the current playlist to the selected bank (A/B/C). Once a playlist has been saved, you can press these buttons to open Library View with the saved playlist selected. Press and hold **Shift** and press these buttons to remove the selected playlist from the bank. While viewing the **Source** menu, press and hold these buttons to save the currently highlighted source to the selected bank (A/B/C). Once a source has been saved, you can press these buttons while viewing the Source screen to select the saved source. Press and hold **Shift** and press these buttons to remove the saved source from the selected bank while viewing the Source screen.
8. **Mixer / EQ:** Press this button to open the **Mixer** menu, where you can select input sources, perform fader calibration, and adjust microphone and EQ settings.
9. **Record:** Press this button to open the **Record** menu, where you can record performances to a selected media destination.
10. **Quantize:** Press this button to activate or deactivate the **Quantize** feature. When enabled, time-based features like triggering cues and loops will snap to the beat grid according to the **Cue/Loop Quantization** setting in the **Profile > Cues/Loops** menu.

Mixer Controls

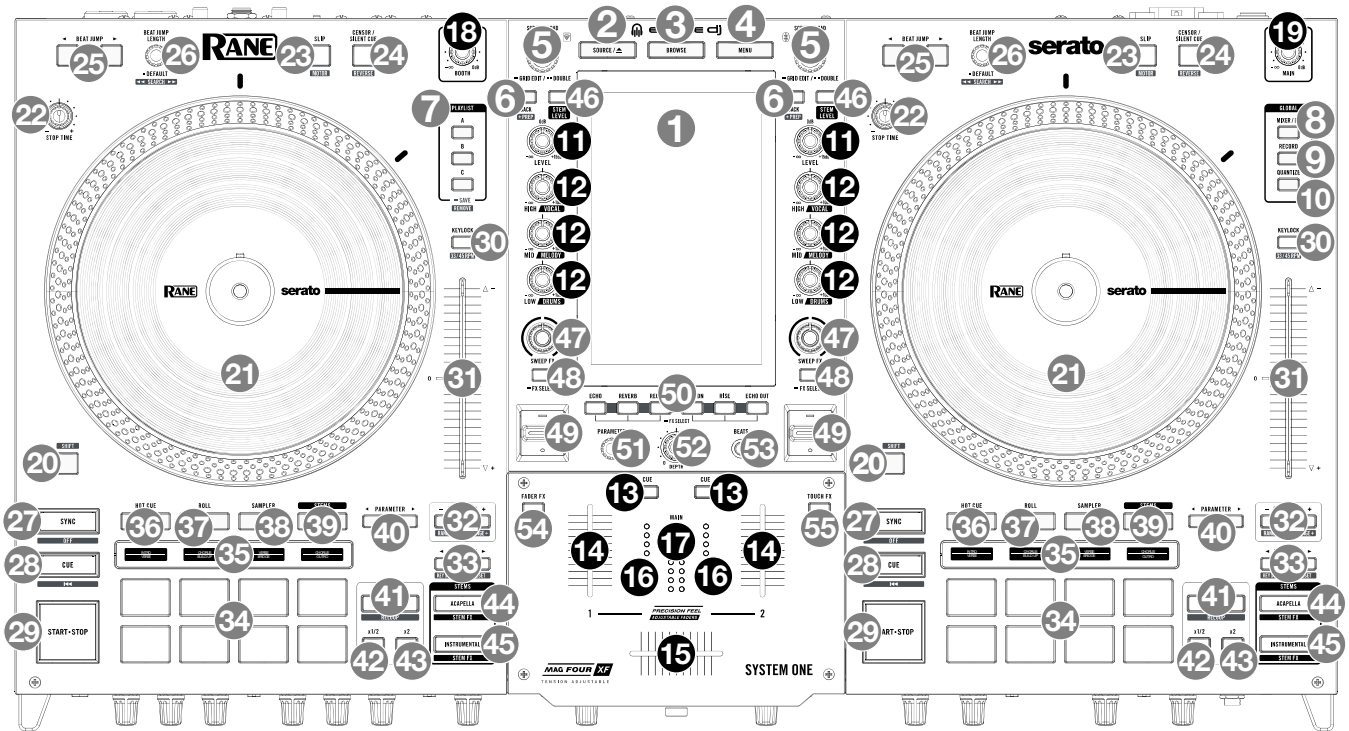

11. **Channel Level:** Turn this knob to adjust the level of the pre-fader, pre-EQ audio signal for the channel.
12. **Channel EQ:** Turn these knobs to boost or cut the high, mid-range, and low frequencies for the channel. When the **Stem Level** button is engaged, use these knobs to adjust the level of the **Vocal**, **Melody + Bass**, and **Drums** stems.
13. **Channel Cue:** Press this button to send the channel’s pre-fader signal to the headphones’ cue channel.
14. **Channel Fader:** Use this fader to adjust the channel’s volume level.
15. **Crossfader:** Use this crossfader to mix between channels assigned to the left and right sides of the crossfader. You can also disable the crossfader by opening the **Control Center** and tapping the **X Fader** button.
16. **Channel Level Meters:** These LEDs display the audio signal level of the channel.
17. **Main Level Meters:** These LEDs display the audio signal level of the program mix (sent out of the **Main Outputs**).
18. **Booth:** Turn this knob to adjust the **Booth Output** volume level.
19. **Main:** Turn this knob to adjust the **Main Output** volume level.

Deck Controls

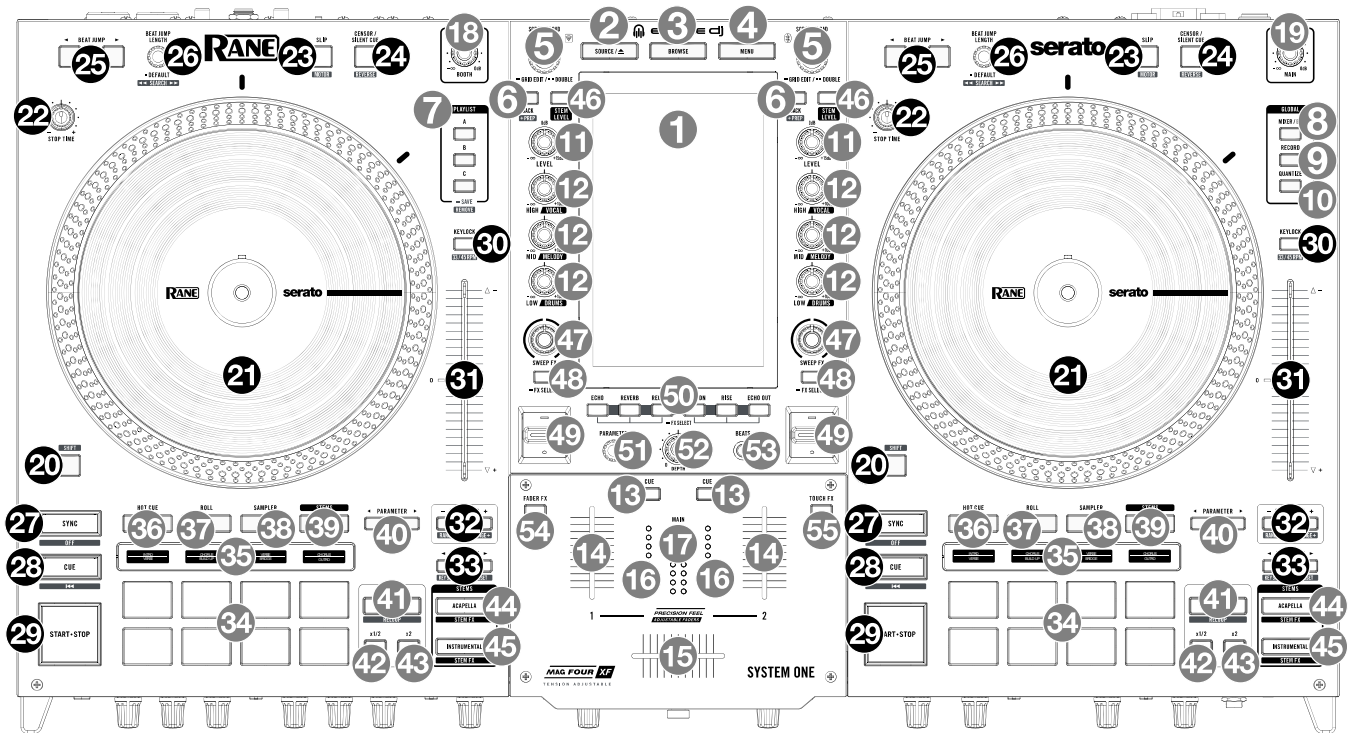

- 20. **Shift:** Press and hold these buttons to access secondary functions of other controls.
- 21. **Motorized Platter:** These motorized platters control song position, scratching, and pitch bend. See the [Setup > Platter Assembly](#) section for more information on setting up and customizing the feel of your platters.
- 22. **Stop Time:** Use these knobs to adjust the amount of time it takes to stop the platter. This can be used for classic “spindown” effects when stopping playback. Turn the knobs to the left to decrease the stop time, and turn the knobs to the right to increase the stop time.
- 23. **Slip / Motor:** Press these buttons to activate or deactivate **Slip** mode for the selected deck. In Slip mode, you can jump to cue points, trigger loop rolls, or use the platters, while the track’s timeline continues. In other words, when you stop the action, the track will resume normal playback from where it would have been if you had never done anything (i.e., as if the track had been playing forward the whole time).
Press and hold **Shift** and press these buttons to enable or disable the motor for the selected deck’s platter.
- 24. **Censor/Silent Cue / Reverse:** Press these buttons to activate the **Censor** feature on the selected deck: the playback of the track will be reversed, but when you release the button, normal playback will resume from where it would have been if you had never engaged the Censor feature (i.e., as if the track had been playing forward the whole time).
The primary function of this button can also be changed to **Silent Cue** in the [Profile > Playback](#) menu. Silent Cue temporarily mutes the deck audio until a Hot Cue pad is pressed. This allows you to play a track from the desired position and unmute the deck with a single button press.
Press and hold **Shift** and then press these buttons to activate **Reverse**, which will reverse playback of the selected deck.
- 25. **Beat Jump:** Press either of these buttons to skip backward or forward through the track.
- 26. **Beat Jump Length / Search:** Turn these knobs to adjust the beat jump size.
Push these knobs to reset the beat jump size (default: 4 beats).
Press and hold **Shift** and turn these knobs to seek/search through the timeline of the track loaded to the selected deck.
- 27. **Sync / Sync Off:** Press this button to activate sync.
Press and hold **Shift** and press this button to deactivate sync. You can also set SYSTEM ONE to turn sync on and off without using **Shift** by changing the **Sync Button Action** setting in the [Profile > Playback](#) menu.

28. **Cue / Previous:** During playback, press this button to return the track to the cue point and stop playback.
- To move the initial cue point while the track is paused, move the **platter** to place the audio playhead at the desired location, and then press this button.
- If the deck is paused, press and hold this button to temporarily play the track from the cue point. Release the button to return the track to the cue point and pause it. To continue playback without returning to the cue point, press and hold this button and press the **Start/Stop** button, and then release **Cue**.
- To return to the beginning of the track, press and hold **Shift** and press this button.
- While at the beginning of a track, press and hold **Shift** and press the button again to move to the previous track in the current playlist.
29. **Start/Stop:** This button starts or stops playback.
- Press and hold **Shift** and then press this button to “stutter-play” the track from the initial cue point.
30. **Key Lock / 33/45 RPM:** Press this button to activate or deactivate Key Lock. When Key Lock is activated, the track’s key will remain the same (0%) even if you adjust its speed.
- Press and hold **Shift** and press this button to toggle the **motorized platter** speed between **33 RPM** and **45 RPM**.
31. **Pitch Fader:** Move this fader to adjust the speed (pitch) of the track. You can adjust its total range with the **Pitch Bend** buttons.
- When changing tracks, the position of the **Pitch Fader** may not match the Pitch setting for the new track. Slowly move the **Pitch Fader** in the direction indicated by the white takeover LED until it turns off. At this point, the **Pitch Fader** matches the Pitch setting of the new track and can control it again.
32. **Pitch Bend -/+ / Range -/+:** Press and hold one of these buttons to momentarily reduce or increase (respectively) the speed of the track. By default, these are set to **Progressive** behavior, so the longer you press the button the greater the rate of track speed change. You can adjust this to **Fixed** behavior in the [Profile > Playback](#) menu
- Press and hold **Shift** and then press these buttons to decrease or increase the range of the **pitch fader**.
33. **Key Adjust ◀/▶ / Key Sync / Reset:** Press these buttons to change the key of the track on each deck. You can also adjust this to change the key on a long press instead in the [Profile > Safety](#) menu.
- Press and hold **Shift** and press the **Key Adjust ◀** button to activate **Key Sync** for the current track during playback. The track’s key will sync with the key of the track on the other deck.
- Press and hold **Shift** and press the **Key Adjust ▶** button to reset **Key Sync**.

Pad, Loop, and Stem Controls

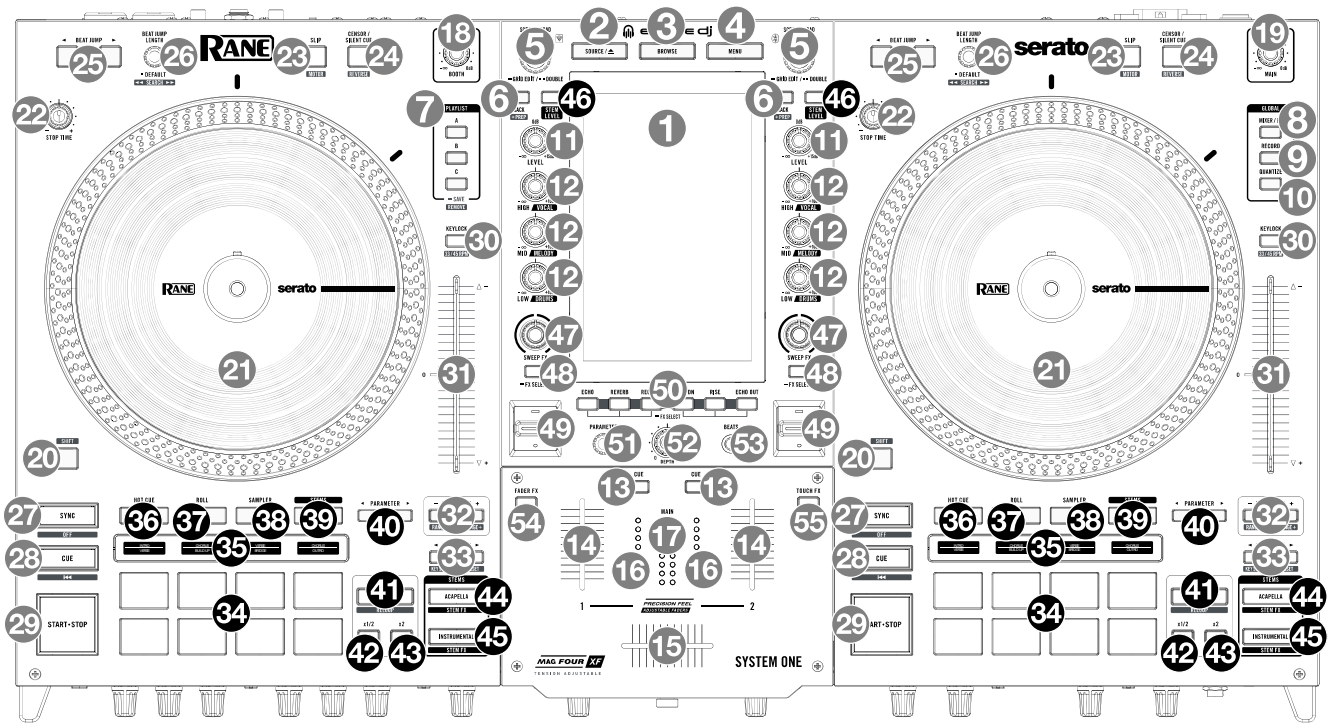

- 34. **Performance Pads:** These pads have different functions on each deck depending on the current pad mode. See [Pad Modes](#) for more information.
- 35. **Performance Pad Displays:** These OLED screens show the pads' various values and functions in each of the available pad modes. Each screen is split into two sections: the top line displays information for Pads 1–4, and the bottom line displays information for Pads 5–8.
- 36. **Hot Cue:** Press this button to enter Hot Cue Mode.
Quickly double-press this button to enter Pitch Play Mode when connected to Serato DJ.
- 37. **Roll:** Press this button to enter Roll Mode.
Press this button a second time to enter Loop Mode.
- 38. **Sampler:** Press this button to enter Sampler Mode.
Quickly double-press this button to enter Scratch Bank Mode when connected to Serato DJ.
- 39. **Stems:** Press this button to enter Stems Mode if a stemmed track is loaded to the deck. If a non-stemmed track is loaded to the deck, press this button to enter Slicer Mode instead.
If a stemmed track is loaded to the selected deck, press this button a second time to enter Slicer Mode.
- 40. **Parameter ◀/▶:** Use these buttons for various functions in certain Pad Modes. See [Pad Modes](#) for more information.
- 41. **Loop On/Off / Reloop:** Press these buttons activate or deactivate an automatic loop at the current location of the track. The placement will be affected by the **Quantize** and **Smart Loops** settings. See [Looping & Beat-Jumping](#) for more information.
Press and hold **Shift** and press these buttons to reactivate the last loop during playback.
- 42. **x1/2 / Loop In:** Press this button to halve the current size of the loop.
When there is no Loop engaged, press and hold **Shift** and then press this button to set a Loop In point at the current playhead location. The placement will be affected by the **Quantize** and **Smart Loops** settings.
If there is an engaged loop, press and hold **Shift** and then press this button to fine-tune the location of the Loop In point using the **platter**.
- 43. **x2 / Loop Out:** Press this button to double the current size of the loop.
When a Loop In point has been set, press and hold **Shift** and then press this button to set a Loop Out point at the current playhead location. The placement will be affected by the **Quantize** and **Smart Loops** settings.
If there is an engaged loop, press and hold **Shift** and then press this button to fine-tune the location of the Loop Out point using the **platter**.

- 44. **Acapella / Stem FX:** Press this button to activate an instant Acapella, muting the **Melody**, **Bass**, and **Drums** stems to isolate the **Vocal** stem.
Press and hold **Shift** and press this button to trigger the instrumental echo out FX.
- 45. **Instrumental / Stem FX:** Press this button to activate an instant Instrumental, muting the **Vocal** stem to isolate **Melody**, **Bass**, and **Drums** stems.
Press and hold **Shift** and press this button to trigger the acapella echo out FX.
- 46. **Stem Level:** Press this button to enable the **Channel EQ** knobs to adjust the level of the **Vocal**, **Melody + Bass**, and **Drums** stems.
While **Stem Level** is activated, the **Stem Level** button will flash if the current **Channel EQ** knob position does not match the current Stem Level setting. Moving the knob will initiate a “soft takeover” once the current setting position is reached, and the Stem Level button will stop flashing.

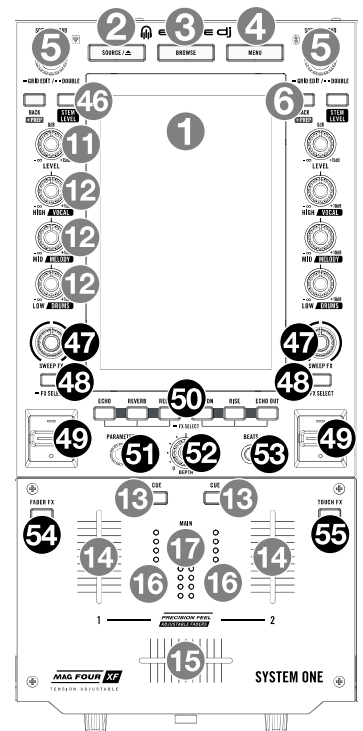

FX Controls

- 47. **Sweep FX:** Turn this knob to control the selected Sweep FX.
- 48. **Sweep FX On/Off / Sweep FX Select:** Press this button to activate or deactivate Sweep FX.
Press and hold this button to open the Sweep FX selection menu and select and adjust the desired effect. See **Sweep FX** for more information.
- 49. **FX Toggle:** Move this toggle switch away from you to activate the selected BPM FX—the toggle will latch to that position. Pull the toggle back to the center position to deactivate the effect.
Pull and hold this toggle toward you to activate the selected effect momentarily, and release the toggle to deactivate the effect—the toggle will return to the center position.
- 50. **FX Select 1–6:** Press these buttons to select and arm internal BPM FX or software effects.
Press and hold these buttons to open the BPM FX Select menu to select different effects for each button. See **BPM FX** for more information.
Note: To use software effects, you must connect SYSTEM ONE to Serato DJ and then select the **Software FX** button in the Control Center. This will disable internal effects and give exclusive control of the FX controls to Serato DJ.
- 51. **FX Parameter:** Use this encoder to adjust the BPM FX parameter. Push this knob to cycle through available parameters for the selected effect.
- 52. **FX Depth:** Turn this knob to adjust the amount of output signal from the BPM FX module.
- 53. **FX Beats:** Move the joystick up or down to increase or decrease the time division for BPM FX.
- 54. **Fader FX On/Off / Setup:** Press this button to activate or deactivate Fader FX. When enabled, you can use the **Channel Faders** and **Crossfader** to apply and control effects.
Press and hold this button to open the Fader FX setup mode. While active, you can select the desired Fader effect from the touchscreen. See **Fader FX** for more information.
- 55. **Touch FX:** Press this button to open the **Touch FX** view on the touchscreen. If Touch FX is engaged and **Latch** is activated, but you are no longer viewing the Touch FX menu, this button will flash.

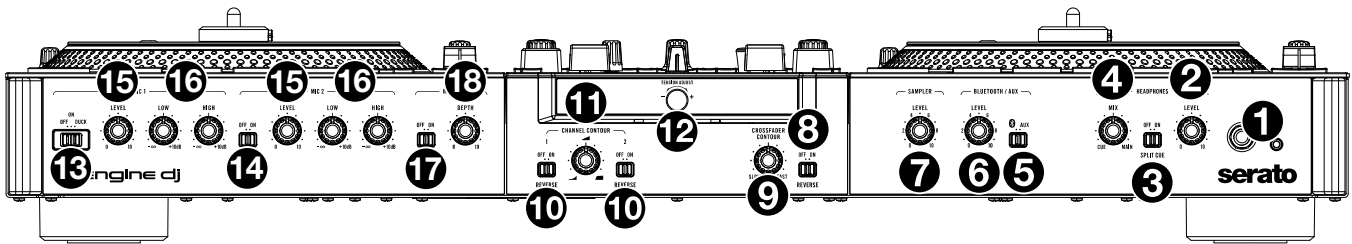

Front Panel



1. **Headphones (1/4", 1/8") (6.35 mm, 3.5 mm):** Connect your stereo headphones to these outputs for cueing and mix monitoring. The headphone volume is controlled using the **Headphones Level** knob.
2. **Headphones Level:** Adjusts the volume of the headphones.
3. **Split Cue:** When this switch is in the **On** position, the headphone audio will be “split” such that the cue channel is summed to mono and sent to the left headphone channel while the program mix is summed to mono and sent to the right headphone channel. You can swap the left/right position of these channels in the [Settings > Mixer](#) menu. When this switch is in the **Off** position, the cue channel and program mix will be “blended” together. In both cases, use the **Headphones Mix** knob to control the blend of the two signals.
4. **Headphones Mix:** Adjusts the audio output to the headphones, mixing between the **Cue** output and the **Main** mix output.
5. **Bluetooth/Aux:** Use this switch to toggle between an active **Bluetooth** audio input or the **Aux** input.
6. **Bluetooth/Aux Level:** Adjusts the level of the Bluetooth audio signal in the Main Output mix, or the signal of an auxiliary device connected to the **Aux In** on the rear panel, depending on the position of the **Bluetooth/Aux** switch.
7. **Sampler Level:** Adjusts the level of audio samples played using [Sampler Mode](#) with the Performance Pads in the Main Output mix.
8. **Crossfader Reverse:** Set this switch to **On** to reverse the direction of the crossfader. Set it to **Off** to use the conventional fader direction.
9. **Crossfader Contour:** Adjusts the slope of the crossfader curve. Turn the knob counterclockwise toward **Slow** for a smooth fade (mixing) or clockwise toward **Fast** for a sharp cut (scratching). The center position is a typical setting for club performances.
10. **Channel Contour:** Adjusts the slope of the Channel 1 and 2 fader curves:
 - **Logarithmic Curve**  : Turning the knob clockwise increases the volume rapidly from the bottom of the channel fader’s range, ideal for quick transitions or cutting effects.
 - **Linear Curve**  : Placing the knob in the center position increases volume evenly as the channel fader is moved upward, providing a consistent response throughout.
 - **Exponential Curve**  : Turning the knob counter-clockwise increases the volume sharply near the top of the channel fader’s range, allowing for finer control at lower levels.
11. **Channel Reverse:** Set this switch to **On** to reverse the direction of the Channel 1 and 2 faders. Set it to **Off** to use the conventional fader direction.
12. **Tension Adjust:** Turn this knob to set the crossfader tension to your personal preference. Turn to the right to tighten and turn to the left to loosen the tension.
13. **Mic 1 Off/On/Duck:** Use this switch to turn the **Mic 1 Input** on or off. When this switch is set to the **Duck** position, the **Mic 1 Input** is turned on, and the volume level of the program mix automatically reduces when you speak into it (also known as “talkover”). The duck threshold level can be adjusted in the [Settings > Mic / Aux](#) menu.
14. **Mic 2 On/Off:** Use this switch to turn the **Mic 2 Input** on or off.
15. **Mic 1/2 Level:** Turn these knobs to adjust the volume levels of the corresponding microphone inputs. You can adjust the microphone attenuation in the [Settings > Mic / Aux](#) menu.
16. **Mic 1/2 EQ:** Turn these knobs to boost or cut the **Low** and **High** frequencies for the corresponding microphones.
17. **Mic FX Off/On:** Use this switch to turn the microphone effects on or off. You can adjust the active Mic FX in the [Mixer > Mic / Aux](#) menu.
18. **Mic FX Depth:** Turn this knob to adjust the amount of FX applied to the microphone.

Rear Panel

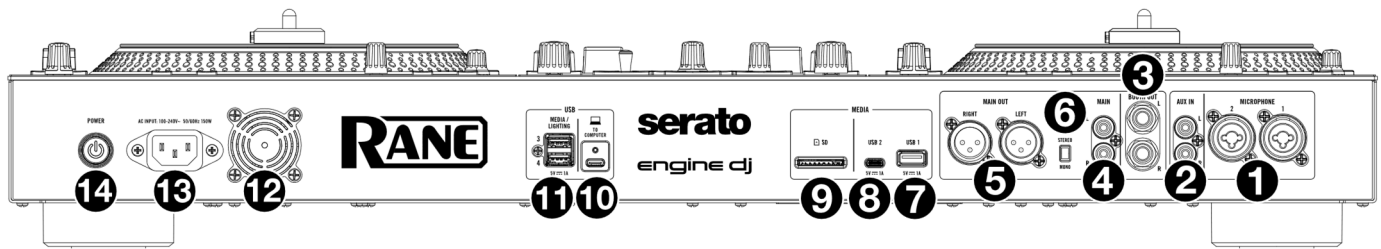

1. **Mic Inputs 1–2 (XLR or 1/4" / 6.35 mm):** Use standard XLR or 1/4" (6.35 mm) cables (not included) to connect standard dynamic microphones to these inputs. Use the **Mic 1** and **Mic 2 Level** knobs on the front panel to control the volume level.
2. **Aux Inputs (RCA, unbalanced):** Use standard RCA cables to connect these line-level inputs to an external audio source. Use the **Aux Level** knob on the front panel to control the volume level.
3. **Booth Outputs (1/4" / 6.35 mm):** Use standard 1/4" (6.35 mm) TRS cables to connect these outputs to booth monitors or a booth amplifier system. Use the **Booth** knob on the top panel to control the volume level.
4. **Main Outputs (RCA, unbalanced):** Use standard RCA cables to connect these outputs to loudspeakers or an amplifier system. Use the **Main** knob on the top panel to control the volume level.
5. **Main Outputs (XLR, balanced):** Use standard XLR cables to connect these outputs to loudspeakers or an amplifier system. Use the **Main** knob on the top panel to control the volume level.
6. **Stereo/Mono:** Use this switch to set the channel configuration of the **Main Outputs: Stereo** (binaural audio using separate left and right channels) or **Mono** (summed monaural audio through both left and right channels).
7. **Media USB Port 1 (USB-A):** Connect a standard USB drive to this USB Type-A port, which you can then select as a source (**Port 1**) and use to load tracks.
8. **Media USB Port 2 (USB-C®):** Connect a standard USB drive to this USB Type-C port, which you can then select as a source (**Port 2**) and use to load tracks.
9. **Media SD Card Slot:** Insert a standard SD card into this slot, which you can then select as a source and use to load tracks.
10. **USB To Computer (USB-C®):** Use a USB-C® cable (included) to connect this USB port to an available USB port on your computer. This connection can be used for **Device Storage Mode** to access the internal drive and connecting to and controlling DJ software like Serato DJ, as well as sending and receiving audio and MIDI messages to and from the computer.
11. **Media/Lighting USB 3/4 (USB-A):** These USB ports can be used to connect standard USB drives for media access, or for connecting a compatible SoundSwitch DMX interface. You can also connect a keyboard to these ports to easily search through your library.
12. **Vent/Fan:** Keep the area in front of this vent clear from obstructions. The fan behind the vent cools the SYSTEM ONE, preventing overheating.
13. **Power Input:** Use the included power cable to connect this input to a power outlet.
14. **Power Button:** Press this button to power SYSTEM ONE on. Power on SYSTEM ONE only **after** you have connected all your input devices and **before** you power on your amplifiers and loudspeakers.
To power off SYSTEM ONE, press this button and follow the prompts on the touchscreen. Power off your amplifiers and loudspeakers **before** powering off SYSTEM ONE.

Operation

Touchscreen Overview

Performance View

Track Overview & Waveform

Swipe up or down (or **left or right**, depending on the chosen layout) on the **track overview** to scan through the track while the track is paused.

Note: You can use this feature during playback when Needle Lock is **off**. If Needle Lock is **on**, stopping the platter with your hand or palm will allow you to swipe through the track overview. See [Profile > Safety](#) to learn about Needle Lock.

Spread or pinch your fingers on a **waveform** to zoom in or out of it, respectively.

Tap the time to switch between the elapsed time and remaining time.

Tap the key to show the Key Change Menu, where you can adjust the key of the track. See [Syncing & Pitch Adjustment](#) for more information.

Tap the track artwork (if shown) to open the track information window. In this window, tap the **star icons** at the bottom of the screen to add or change a track's star rating. Turn the **Scroll / Load Knobs** to scroll through the current track list with the information window open.

Hold Shift and press Menu to cycle between **View 1–3** layout presets. Performance View layouts can be customized using the [Layout](#) menu. The default views will be restored with a factory reset.

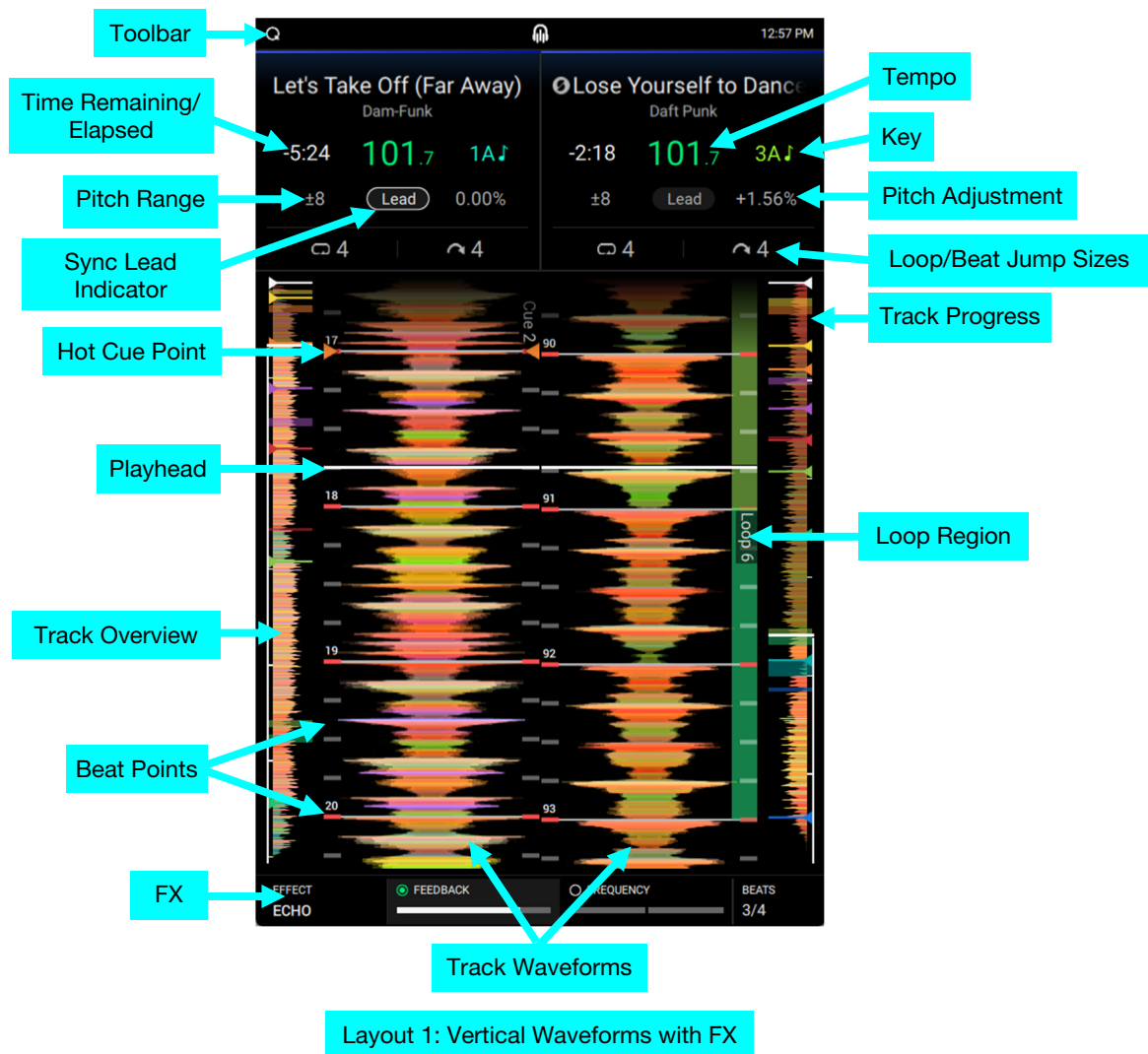

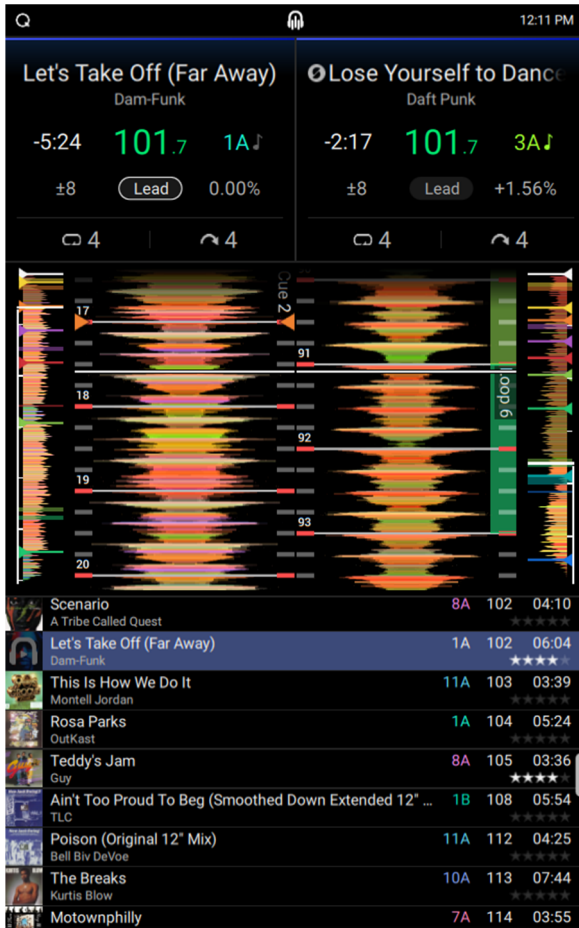

Layout 2: Vertical Waveforms with Performance Library

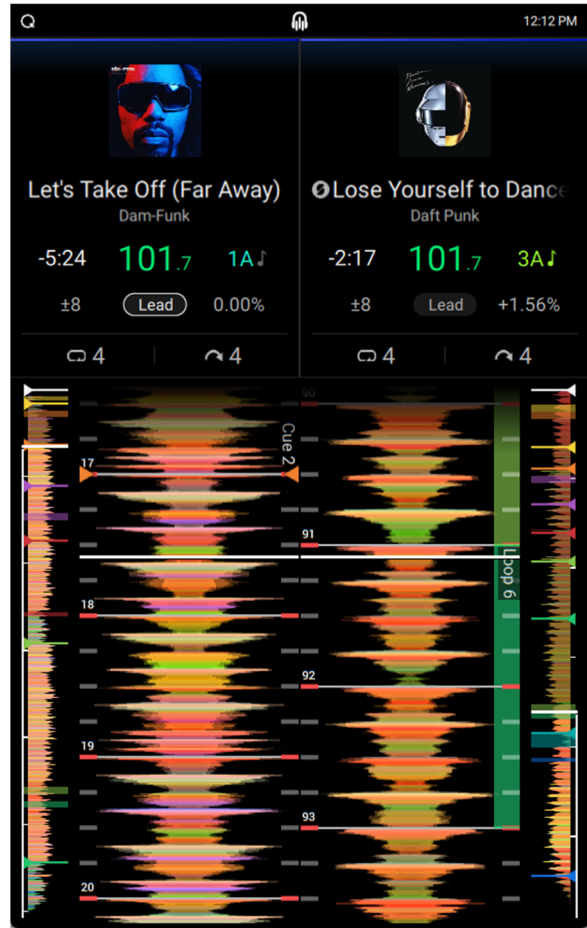

Layout 3: Vertical Waveforms with Album Art

Performance Library

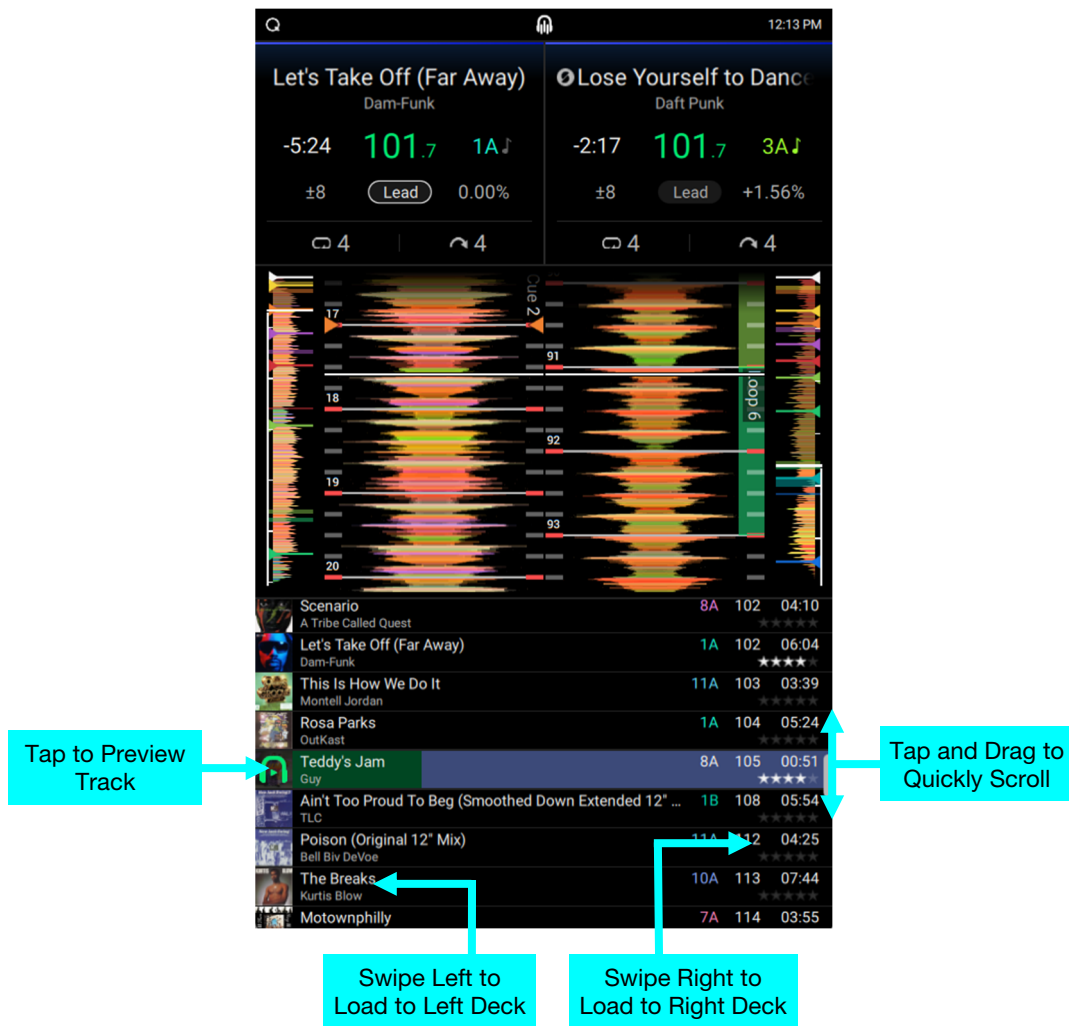

The Performance Library can be enabled or disabled in the **Layout** menu of the **Control Center**. When the Performance Library is shown, you can do the following:

Swipe up or down to browse tracks.

Tap and drag the scroll bar to quickly browse through tracks.

Swipe left to load a track to the left deck. Alternatively, half-swipe left and then tap **Deck 1**.

Swipe right to load a track to the right deck. Alternatively, half-swipe right and then tap **Deck 2**.

Double-tap to load a track to a selected deck or sampler slot.

Tap the track art to preview the track. Tap again to stop previewing. While previewing, tap along the track entry to scan through the track.

Tap and hold a track to view track information. In this window, tap the **star icons** at the bottom of the screen to add or change a track's star rating. Turn the **Scroll / Load Knobs** to scroll through the current track list with the information window open.

Toolbar

The **toolbar** at the top of the touchscreen displays the status of certain hardware and feature settings. **Swipe down** from this area to open the **Control Center**.



Q: Shows the current quantization status. When enabled, time-based features like triggering cues and loops will snap to the beat-grid according to the **Cue/Loop Quantization** setting in the **Profile > Cues/Loops** menu.

To enable quantization, press the **Quantize** button in the **Global** section on the right deck.

Link: Shows the current Ableton Link status. Enabling Ableton Link will synchronize the beat, phase, and tempo of Ableton Live and SYSTEM ONE over a wireless or wired network.

Record: When recording is active, the current record status and time elapsed will be displayed here.

Continue: The figure-eight icon indicates Continue is enabled, which will keep playing the next track when the active track has ended.

Time: Displays the current local time. You can adjust the time in the **Settings > Device** menu.

Note: If your SYSTEM ONE rises above normal operating temperatures, an overheat warning will be displayed in the toolbar. Make sure to leave sufficient space around the SYSTEM ONE for ventilation. If overheating persists, shut down the unit and allow it to cool down to prevent damage.

Library View

Use the full Library View to view your music library and load a track to the deck. You can also search through playlists, add tracks to the Prepare list, and search through your tracks using sorting and filtering features.

Important: Visit enginejdj.com/downloads to download the Engine DJ software.

To open Library View, press **Browse**. Alternatively, if the **Encoder Behavior** option in the **Settings > Device** menu is set to **Open Library**, turn the **Scroll / Load** knobs while in Performance View.

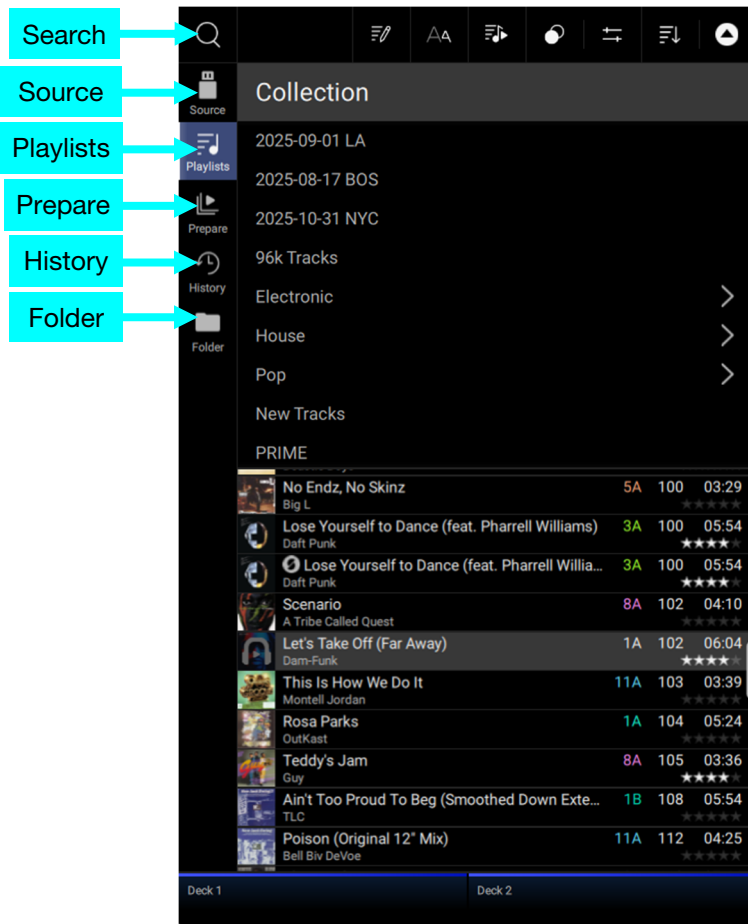

Tap the **Collection** header to expand the list of playlists in your collection. Tapping in the track area will automatically collapse the Collection list.

Tap the **magnifying glass icon** to search through your tracks by keyword. See [Searching & Filtering Tracks](#) for more information.

Use the five icons on the left side to navigate while in Library View:

- **Source:** Tap here to access the Quick Source Menu, where you can swap between connected sources to view and select tracks. Tap the **expand icon** to open the full **Source** menu, where you can connect to available streaming and cloud services, Engine Remote Libraries, and access pre-installed Demo and Sampler content. You can also enable or disable streaming and cloud services using the **Settings > Services** menu.

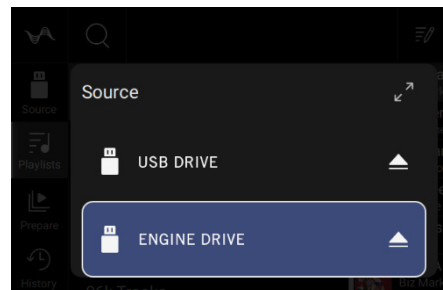

- **Playlists:** Your playlists are your collections of tracks, including lists of tracks arranged in a specific order. You may have playlists for different types of clubs or events, for specific genres, etc. You can create playlists to use here directly on your device (See [Editing Playlists](#)) or by using the included Engine DJ software.
- **Prepare:** You can load tracks to the Prepare list so that you can refer to them later when you want to play them during your performance (rather than searching through your entire library for the next track to play).
- **History:** Use this option to view your playback history.
- **Folder:** Use this option to browse the list of all files on a USB drive, SD card, or installed internal drive.



Tap the Standard/Large Track View icon (AA) at the top of the display to toggle between standard and large list views.

Swipe a list up or down to browse through it (e.g., your list of playlists or your list of tracks). Alternatively, press the **Back** or **Forward** buttons to select a list, and then turn either **Scroll / Load** knob.

Tap and drag the scroll bar to quickly browse through tracks.

Tap an icon or item in a list to select it (e.g., the icons for Playlists, Prepare List, or Files on the left side of the Library). Alternatively, press either **Scroll / Load** knob.

Swipe a track to the left or right to load it to a deck. You can also partially swipe the track to the left or right and then tap **Deck 1** or **Deck 2**, respectively, to load to that deck.

Partially swipe a track to the right and tap **Load** to load it to a deck or sampler slot. Then, tap the desired deck number or sample slot.

Alternatively, double-tap the track, or press the left or right **Scroll / Load** knob, depending on the desired deck where you want to load the track.

Partially swipe a track to the left and tap **Prepare** to add it to the Prepare list. Alternatively, press and hold **Shift** and press the **Back** button. Swipe a track to the left in the Prepare list to remove it.

Partially swipe a track to the left and tap **Stems** to add it to the Stems list. Tracks added to the stems list that have not previously been rendered are processed in the background as you use the SYSTEM ONE and are saved on the current drive for future recall. See [Features > Top Panel > Pad, Loop, and Stem Controls](#) and [Pad Modes > Stems Mode](#) for more information on using the SYSTEM ONE stem controls.

Note: To use onboard stems rendering, you must first download the stems processor. The first time you add a track to the **Stems** list, tap **Yes** in the **Download Engine Stems** window to begin downloading the stems processor. You must be connected to the internet to begin the download. You can also begin the download by going to [Settings > Device](#) and tapping the **Add** button next to the **Add Stems Support** setting.

Tap the track art to preview the track. Tap again to stop the preview. While previewing, tap along the track entry to needle drop through the track.

Tap the Play As Playlist icon to send the currently selected track list to a selected deck. See [Playlist Deck](#) to learn more.

Tap and hold your finger on a track to show its information window (see image, right). In this window, tap the **star icons** at the bottom of the screen to add or change a track's star rating. Turn the **Scroll / Load Knobs** to scroll through the current track list with the information window open. Tap the X in the corner of the window to close it, or press the **Back** button.

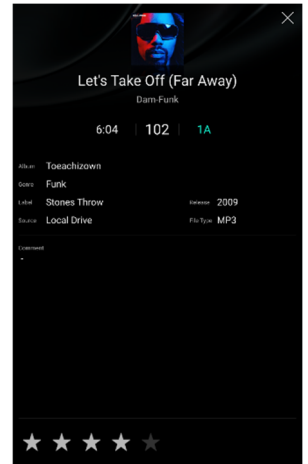

Performing

Loading Tracks

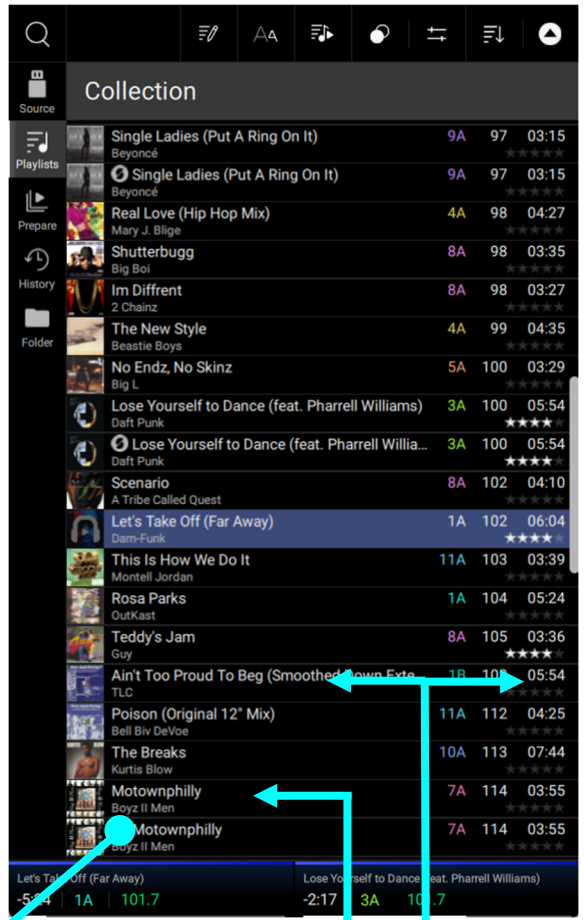
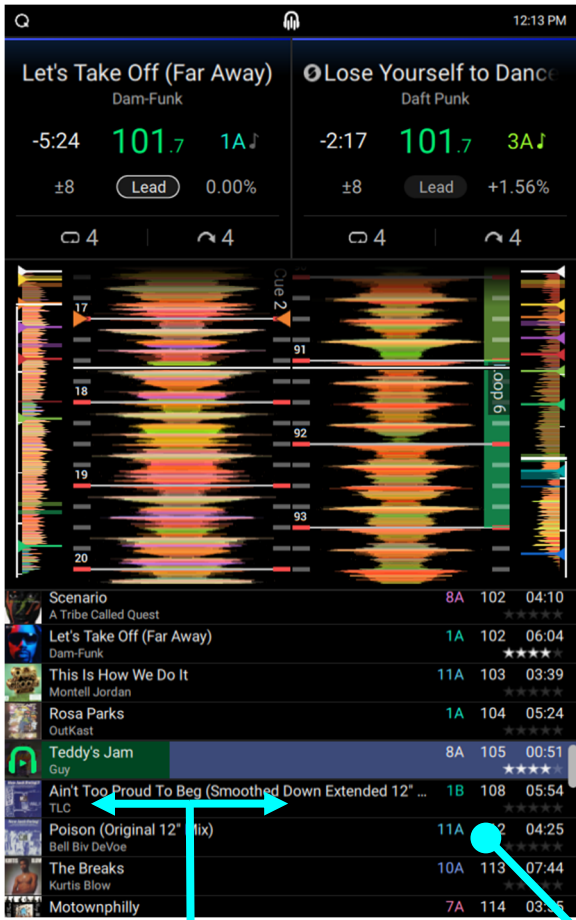

Swipe Right or Left to Load

Tap and Hold to Show Info

Partial Swipe Left to Prepare

Swipe Left or Right to Load

To load a track to a deck, do any of the following:

- In Performance Library or Library View, highlight the track, and then press the left or right **Scroll / Load** knob to load the track to the left or right deck.
- In Performance Library or Library View, swipe the track to the left or right to load the track to the deck on that side.
- In Library View, partially swipe the track to the left or right and then tap **Deck 1** or **Deck 2**, respectively, to load to that deck.
- In Library View, partially swipe the track to the right and then tap **Load**. Next, tap the deck or sampler slot where you want the track loaded.
- Double-tap the track to bring up the deck selection screen. Tap to select the desired deck.

To add a track to the Prepare list, partially swipe the track to the left while in **Library View**, and then tap **Prepare**. Alternatively, press and hold **Shift** and press the **Back** button.

To show a track's information, tap and hold your finger on it. In this window, tap the **star icons** at the bottom of the screen to add or change a track's star rating.

To remove a track from a deck, press and hold **Shift** and then press the left or right **Scroll / Load** knob, depending on the desired deck.

While viewing the Prepare list:

Swipe right to load to a deck.

Swipe left to remove the track from the Prepare list.

Tap the clear icon at the top of the display to remove all tracks from the Prepare list.

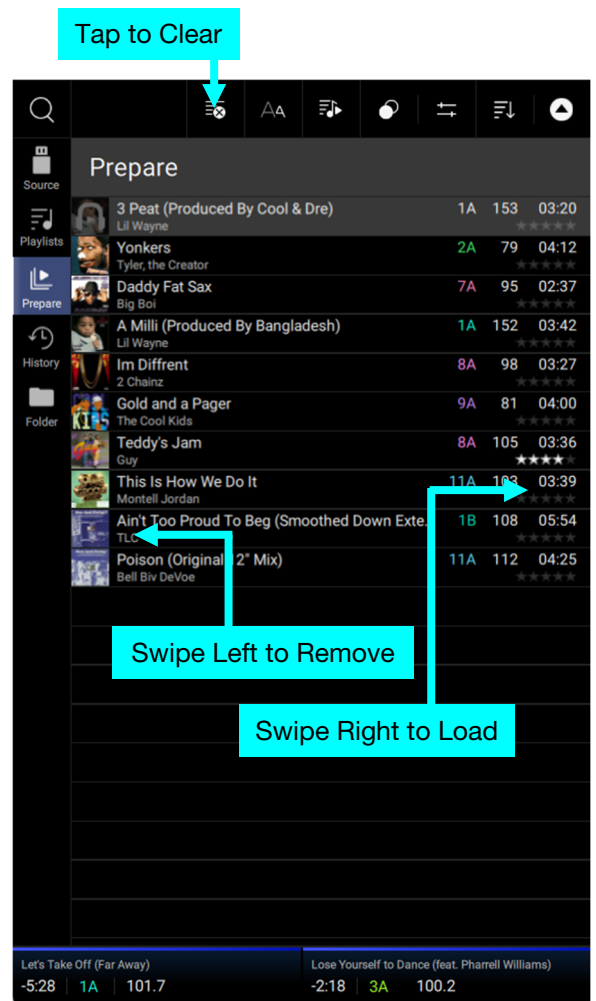

Searching & Filtering Tracks

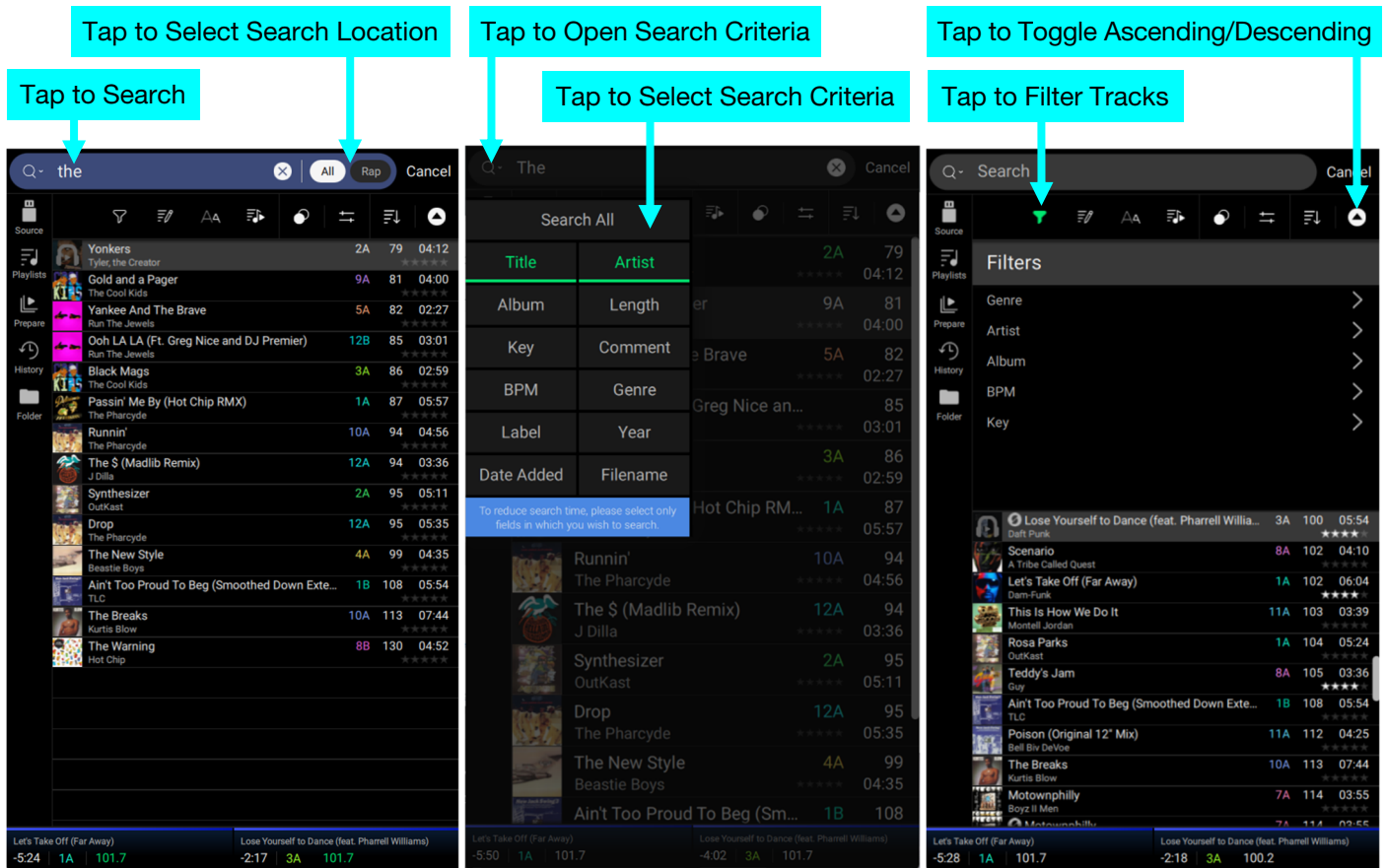

To search tracks, tap the **magnifying glass icon** and use the keyboard that appears in the display.

The search results can be based on the following criteria: title, artist, album, length, key, comment, BPM, genre, label, year, date added or filename. By default, only **Title** and **Artist** are selected. Tap the **magnifying glass icon** again and then use the dropdown menu to select other categories, or to **Search All** categories.

Note: To reduce search time, only select fields in which you wish to search.

When searching from a playlist, you can choose to search only in that playlist (tap the playlist name) or your entire collection (tap **All**).

To hide the keyboard, tap the **keyboard icon** in the lower-right corner of the virtual keyboard. Alternatively, tap anywhere on the screen other than the keyboard or the Search field.

To clear your search term, tap the **X icon**. Tap **Cancel** to stop searching.

To filter your tracks, tap the **Filter icon**, and then select **Genre**, **Artist**, **Album**, **BPM**, or **Key**. Only tracks tagged with that genre, album, artist, BPM, or key will be shown. (By default, the key is notated using the Camelot system.) You can also use the **Search** field while tracks are filtered to refine your results, or filter tracks from a search result.

Note: You can also use the [Profile > Library](#) menu to set whether you want to show tracks with the same key only or tracks with compatible keys as well as the “tolerance” of BPM filter (to include tracks with tempos within 1–15 BPM of the selection).

To sort the list of results, tap the **Sort By icon** in the upper-right corner, and then tap one of the available options. Tap the **arrow icon** next to this to toggle between ascending and descending order.

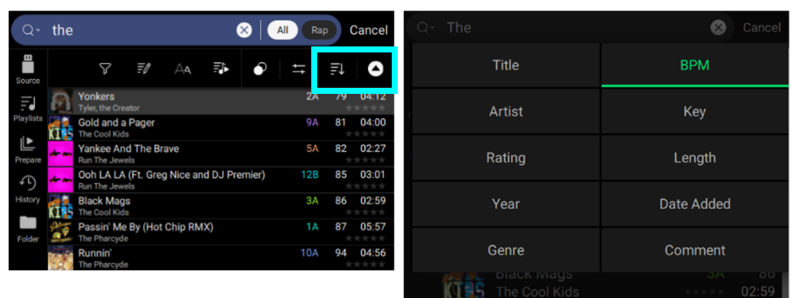

Match

In addition to the examples above, you can also use the **Match** tool to filter tracks that match the current lead track using a customizable set of parameters.

The Match function can be used in Playlist, Search, Prepare, and History views of the Browser. You can also access Match rules when viewing your Engine Remote Library.

Click the **sliders icon** to open the Match Rules screen, where you can select the following options for filtering tracks:

Follow Lead Deck: When enabled, tracks will be matched to the current Sync Lead deck. When disabled, use the following option to select the match deck.

Match to Deck: When Follow Lead Deck is disabled, use this option to select the deck for matching tracks.

BPM: Enable to match tracks by BPM. Use the - and + buttons to set the BPM range to match.

Key: Enable to match tracks by key. Select **Fuzzy** (includes relative keys of the dominant and subdominant keys of the lead track), **Compatible** (includes relative keys of the lead track), or **Exact** (includes only the same key of the lead track).

Genre: Enable to match track by genres. Select **Close** to include related genres (e.g., “Deep House” or “Acid House” will match to a track tagged with “House”), or **Exact** to match only the exact genre of the selected deck’s track.

Hide Played: When enabled, previously played tracks (highlighted in green text) will be hidden from the match results.

Note: Hide Played is unavailable when using Match in History view.

Once the Match Rules are set, tap the **match (circles) icon** to display the matching tracks in the list. If no tracks match the set rules, a message will appear in the track list noting that tracks may be hidden. Match results can be further sorted using the **Sort By** preferences and **Ascending/Descending** order.

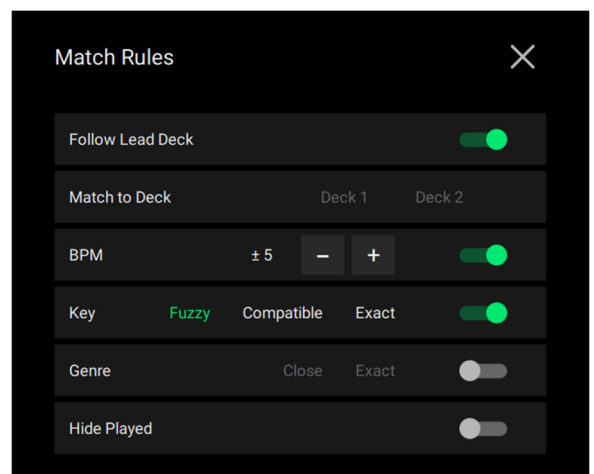
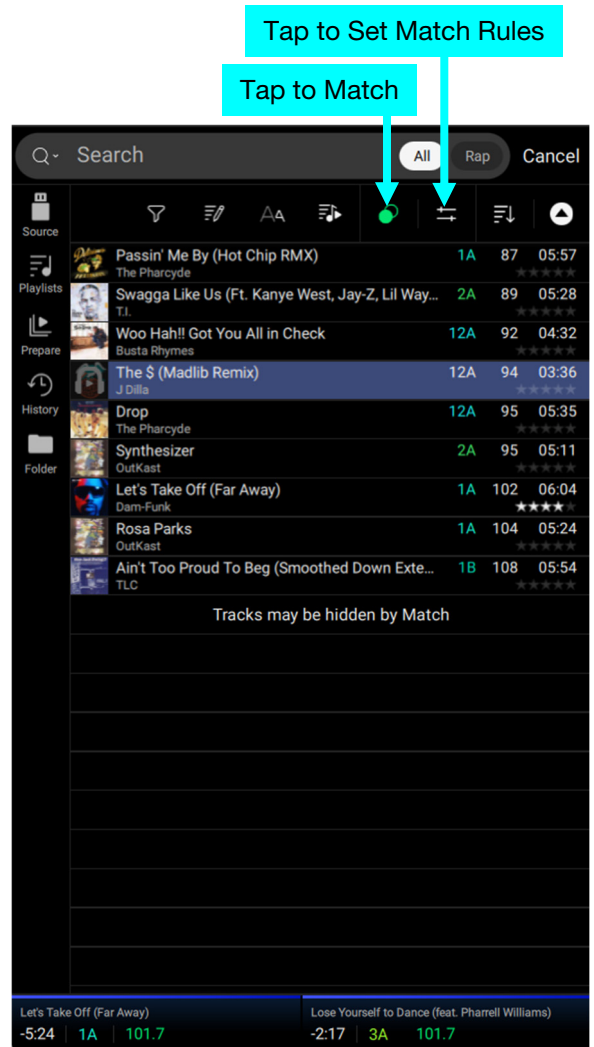

Editing Playlists

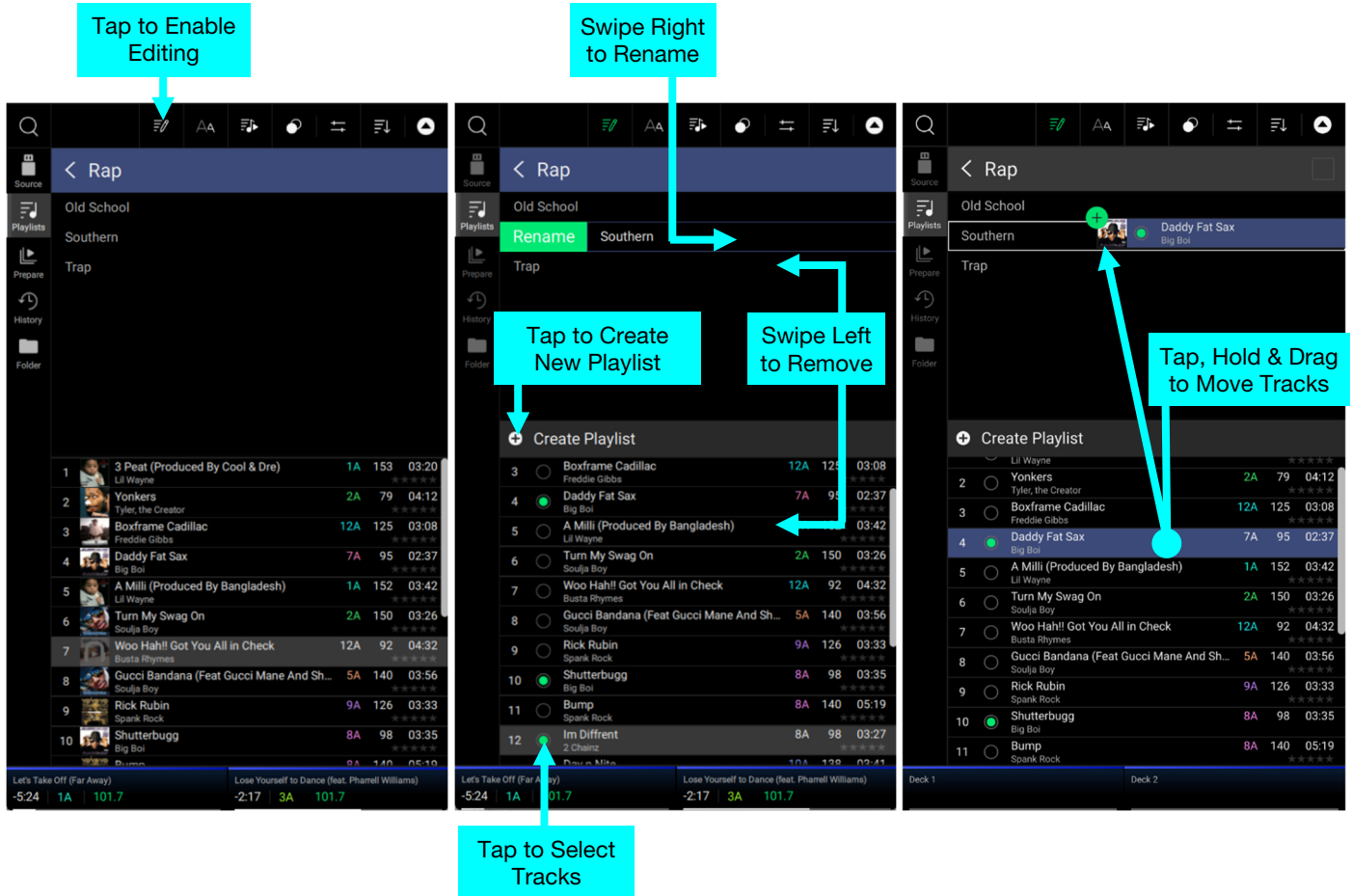

Tap the edit icon at the top of the display while viewing the playlist screen. While editing is active, you can do any of the following:

To make a new playlist, tap **Create Playlist** in Playlist view.

To rename a playlist, swipe right on the playlist name. Use the keyboard that appears to type a new name, and then tap **Rename** to confirm. To exit without renaming, tap **Cancel**.

To add tracks to your playlist, tap a track to select it, and the open circle will become filled. After selecting tracks, tap and hold to move the tracks. You can drag the tracks over a playlist or folder and release your finger to instantly add them.

To remove a track from your playlist, swipe left on the track name, and then tap **Remove From Playlist**.

To reorder tracks in a playlist, first make sure the **Sort Preference** is set to **Play Order**. Then, tap and hold on the track name (while editing mode is still active) and move your finger up or down to change the track order. You can also reorder playlists in the same way.

To remove a playlist, swipe left on the playlist name. A pop-up will appear for confirmation. Tap **Yes** to remove the playlist, or **No** to return to editing. Tracks in a removed playlist will remain in your collection.

Playlists can also be quickly saved and recalled directly from the SYSTEM ONE hardware.

While in Library View, press and hold one of the **Playlist A/B/C** buttons to save the current playlist to the selected bank (A/B/C).

Once a playlist has been saved to a bank, press the **Playlist A/B/C** buttons to open Library View with the saved playlist selected.

Press and hold **Shift** and press **Playlist A/B/C** buttons to remove the selected playlist from the bank.

Playlist Deck

While in Library View, you can send the currently viewed file list to its own deck to play as a playlist.

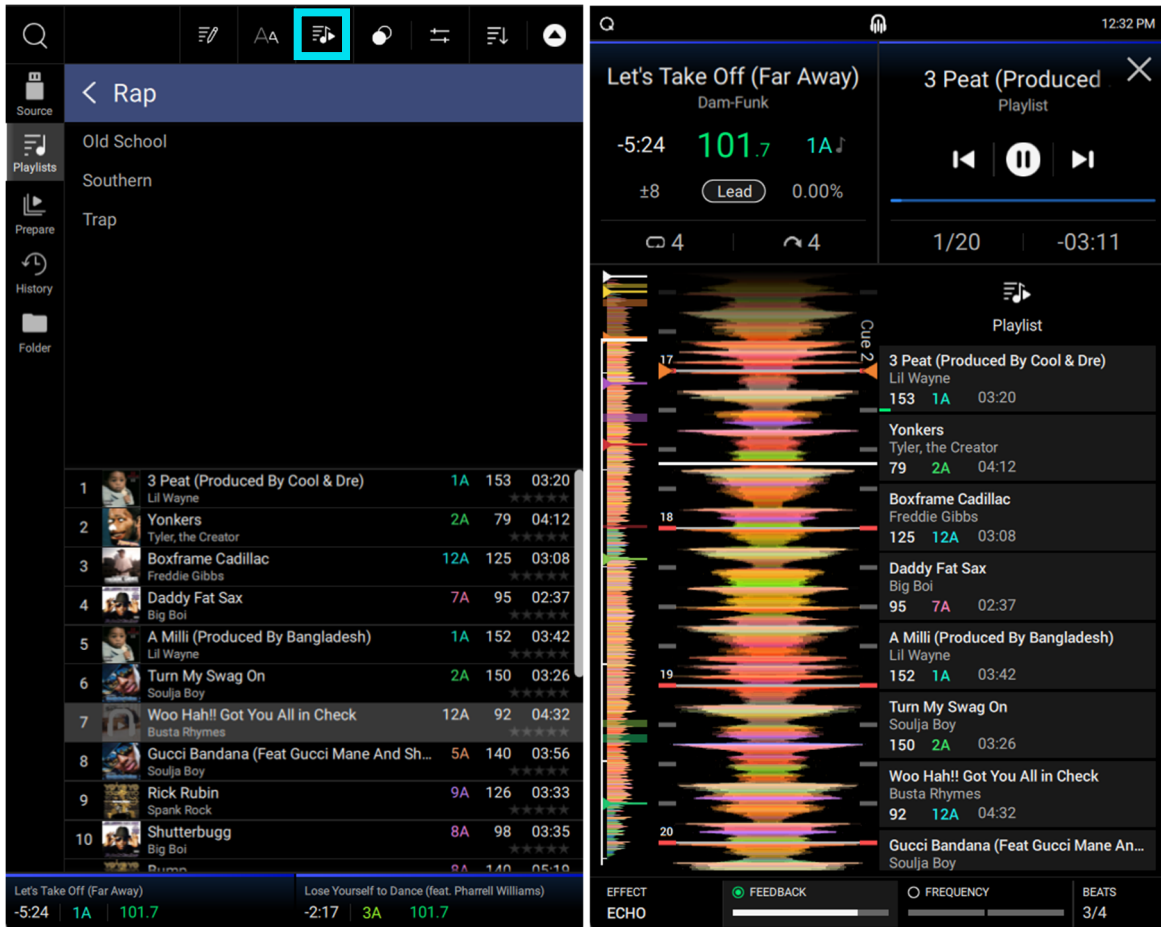

To enable Playlist Deck, tap the **Play As Playlist** icon in Library view. Then, select which deck you would like to use for the playlist. When enabled, the playlist deck will play through the selected track list and automatically crossfade between each track according to the **Playlist Deck Crossfade Time** parameter in the [Settings > Mixer](#) menu.

To enable playlist deck playback, press **Play** on the selected deck.

To change tracks within the playlist, use the **track backward** and **track forward** buttons in the track overview area.

To remove the playlist from the deck, tap the **X** in the track overview area.

Playback & Cueing

To play or pause a track, press **Start/Stop**.

To scratch a track, move the **platter** while a track is loaded. By default, the motorized platter is activated. To turn off the motor, press and hold **Shift** and press **Slip / Motor**.

To set the cue point, pause the track (or hold the platter during playback) and press **Cue** at the desired location.

To return to the cue point and stop, press **Cue** during playback.

To return to the cue point and keep playing, press and hold **Shift** and press **Start/Stop**.

To return to the beginning of the track, press and hold **Shift** and press **Cue**.

To jump to a specific location in the track:

- If Needle Lock is **disabled**: tap the desired location in the track overview.
- If Needle Lock is **enabled**: pause playback and then tap the desired location in the track overview. Alternatively, make sure the **motor** is **on**, then stop the platter with your hand or palm to swipe through the track overview.

See [Profile > Safety](#) to learn about Needle Lock.

To scan quickly through the track, press and hold **Shift** and turn the **Beat Jump Length / Search** knob. Alternatively, drag your finger left or right through the waveform overview on the display. If Needle Lock is enabled, pause playback or stop the platter before doing so.

To zoom in and out of the waveform, place two fingers on the display and spread them apart or pinch them together.

To censor playback, press and hold **Censor/Silent Cue**.

To return to normal playback, release **Censor/Silent Cue**. Normal playback will resume from where it would have been if you had never engaged the Censor feature (i.e., as if the track had been playing forward the whole time).

To reverse playback, press and hold **Shift** and press **Censor/Silent Cue / Reverse**. The button will flash while playback is reversed.

To return to normal playback, press and hold **Shift** and press **Censor/Silent Cue / Reverse** again.

To enable or disable Slip Mode, press **Slip**. In Slip Mode, you can jump to cue points, use the platters, or pause the track while the track's timeline continues (half of the waveform in the main display will continue moving forward). When you stop whatever action you are performing, the track will resume normal playback from where it would have been if you had never done anything (i.e., as if the track had been playing forward the whole time). The button will flash while Slip is active.

Looping & Beat-Jumping

To create and engage an auto loop, press the **Loop On/Off** button. You can adjust the default loop length using the **Default Loop Size** setting in the [Profile > Cues/Loops](#) menu.

To disengage a loop, press the **Loop On/Off** button again.

To create and engage a manual loop, press and hold **Shift** and press the **x1/2 / Loop In** button to set the start point, and then press and hold **Shift** and press the **x2 / Loop Out** button to set the end point. The loop will be engaged immediately, and the loop will be indicated as a shaded area in the waveform and track overview.

If there is an engaged loop, press and hold **Shift** and then press **x1/2 / Loop In** or **x2 / Loop Out** to fine-tune the location of the loop in and loop out points, respectively, using the **platter**.

To re-engage the last loop during playback, press and hold **Shift** and press the **Loop On/Off / Reloop** button.

To double or halve the length of a loop, press the **x1/2** or **x2** buttons, respectively, while the loop is engaged.

To beat-jump through a track, press one of the **Beat Jump** buttons. Each press will skip through the track by the set length.

To set the beat jump length, turn the **Beat Jump Length** knob. Press and hold **Shift** and press this knob to reset the beat jump length to the default value. This can also be set using the **Default Beat Jump Size** setting in the [Profile > Cues/Loops](#) menu. The beat jump length in the deck info will change as the value is adjusted.

You can also create and manage loops with the **Performance Pads** using [Loop Mode](#).

Syncing & Pitch Adjustment

To enable sync, press **Sync**. The track tempo will change color when sync is enabled. Tracks that are not synced will have their tempo displayed in white.

Note: Colors will appear differently when **Day Mode** is enabled in the **Control Center**.

To set which deck is the “sync lead,” or the deck that controls the sync BPM, tap the deck tempo or the **LEAD sync indicator**. The **LEAD sync indicator** for the deck will become highlighted when set as the sync lead.

After sync is activated and the sync lead is set, press **Sync** on any additional decks. The tempo of each deck will immediately synchronize to match the tempo of the sync lead deck.

The sync behavior is determined by the **Sync Mode** setting in the **Profile > Playback** menu.

To deactivate sync on a deck, press and hold **Shift** and press **Sync**, or press **Sync** again, depending on the setting of **Sync Button Action** in the **Profile > Playback** menu.

To adjust the track’s pitch, move the **pitch fader**. You can do this only when the deck is not synced. The pitch value in the deck info will change as the pitch is adjusted.

If syncing a track changes the current tempo away from the physical pitch fader position, the **takeover arrows** on the deck will light to indicate which direction to move the pitch fader in order to match the new tempo.

To adjust the track’s pitch momentarily, press and hold one of the **Pitch Bend +/-** buttons.

To adjust the range of the pitch fader, press and hold **Shift** and press the **Pitch Bend +/-** buttons to decrease or increase the range to **±4%, 8%, 10%, 20%, 50%, or 100%**. The pitch range display in the deck info will change as the range is adjusted.

To change the track’s key, press the **Key Adjust ◀▶** buttons. You can determine whether this operates on a short-press (**Normal**) or **Long Press** using the **Key Adjust** setting in the **Profile > Safety** menu.

To lock or unlock the track’s key, press **Keylock**. When Key Lock is activated, the track’s key will remain the same even if you adjust its speed.

To reset the track’s key and lock it, press and hold **Shift** and press **Key Adjust ▶**.

To activate key sync, press and hold **Shift** and press **Key Adjust ◀** during playback. The track’s key will sync with the key of the track on the other deck. The key value will depend on the **Key Sync Mode** setting in the **Profile > Playback** menu.

To change the key using the touchscreen, tap the key in Performance View to open the Key Change Menu. In the Key Change Menu, you can access the following controls:

Tap the **musical note** to lock or unlock the track’s key.

Tap the **Sync** button to enable Key Sync.

Tap the **key values** to decrease or increase the key. The key in the center will update to show the new key and the amount of change from the original key.

Tap the **reset** button to reset the key.

Tap the **X** button to close the Key Change Menu.

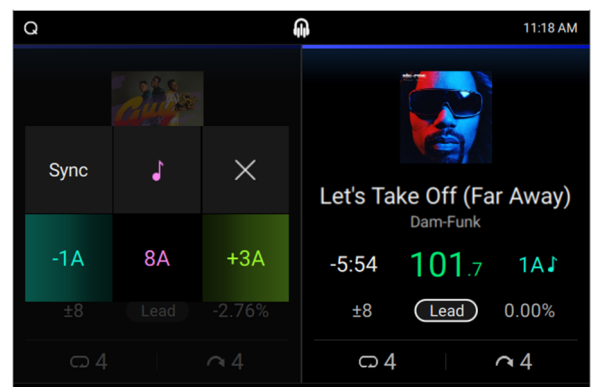

Beat Grid Editing

You can edit a track's beat grid directly from your SYSTEM ONE hardware, in the same way you can when using the Engine DJ software.

To enable beat grid editing, do any of the following:

- Press and hold the **Scroll / Load** knob on each deck.
- Open the **Control Center** and tap the **Beat Grid Edit** icon. When accessing via the Control Center, you may need to tap the Deck 1 or Deck 2 **Track Information** area at the top of the screen to ensure you are editing the desired track.

Note: Beat grid editing is not accessible if there are no tracks added to the decks, if the deck is in use with a Computer Input and Serato DJ, if the deck is in use with Bluetooth, or if the deck is in use as a Playlist Deck.

Important: When the **Cue/Loop Quantization** feature is **on**, hot cue points and loop points will be automatically aligned according to the degree of quantization. See [Profile > Cues/Loops](#) to learn about this.

To adjust the position of the beats:

- Tap the **Downbeat Left/Right** buttons to move the beats based on the current analyzed grid.
- Tap the **Shift Left/Right** buttons or nudge the hardware platter to "slip" the entire grid left or right.
- Tap the **Insert Anchor** button to move the closest beat to the position of the playhead. All other beats will also shift accordingly. This allows you to create flexible beat grids for tracks with fluctuating tempo.
- Tap the **Delete Anchor** button to delete the closest anchor within a few beats.

To adjust the tempo:

- Tap the **BPM** field to input a new tempo. Use the number pad that appears to input the new value, and then tap the **Enter** button to accept it. Tap the **X** icon to cancel changes and return to the grid edit controls.
- Tap in the **Tap Tempo** icon area to manually set a tempo based on repeated taps.
- Tap the **Decrease/Increase BPM** buttons to decrease and increase BPM in small increments.
- Tap the **2X** and **/2** buttons to double or halve the current BPM.

To reset the beats to the original analyzed tempo and grid, tap the **Reset** button.

To lock the beat grid, tap the **lock** icon. When locked, further editing is prevented and all other Grid Edit controls will be greyed out.

To select another track for editing, tap the **Track Information** area.

To exit beat grid editing, tap the **X** in the top-right corner of the touchscreen, or select another mode.

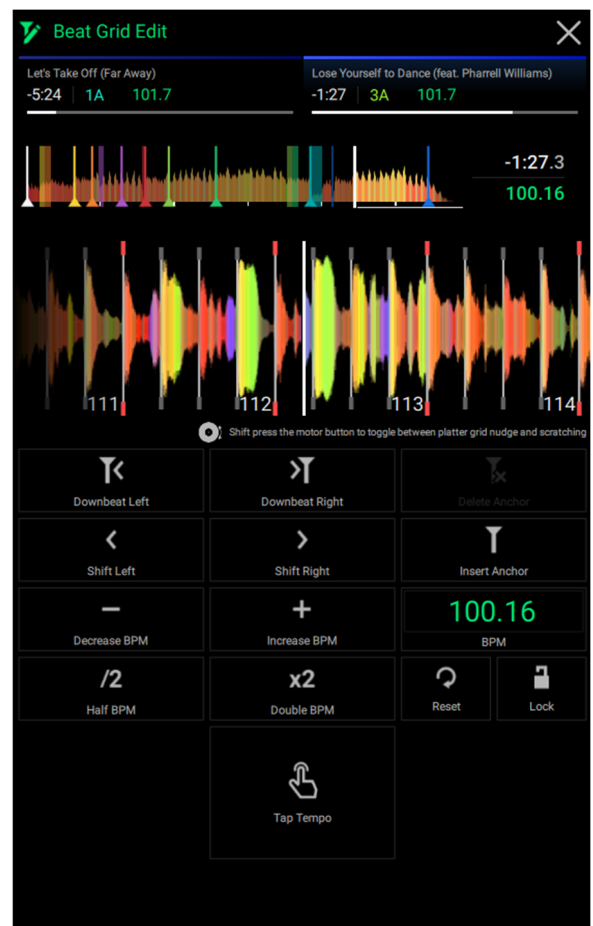

Pad Modes

The eight performance pads on each deck have different functions in each pad mode.

Hot Cue Mode

In Hot Cue Mode, you can use each pad to jump to an assigned hot cue point. The location of set hot cue points and timing of triggered hot cue points will depend on the current **Quantize** setting, if enabled.

Tip: You can use the Engine DJ software to set, name, and assign colors to your hot cue points. The names will appear on the **Performance Pad Displays**, and the colors will appear in the track overviews for reference.

To enter Hot Cue Mode, press **Hot Cue**.

To assign a hot cue to a pad, press an unlit pad at the desired location in the track. The pad will light up when a hot cue point is assigned.

To jump to a hot cue point, press the corresponding pad.

To clear a hot cue from a pad, press **Shift** and the desired pad. The pad will turn off when there is no hot cue point assigned to it.

Pitch Play Mode

Important: This mode only functions when using Serato DJ Pro with the included Serato Pitch 'n Time DJ Expansion Pack installed.

In Pitch Play Mode, each pad plays the track from a hot cue point at a different transposition (adjustable by semitones). See **Hot Cue** to learn how to assign hot cue points.

To enter Pitch Play Mode, quickly double-press the **Hot Cue** button while using Serato DJ Pro.

To select which hot cue point to use, press **Shift** and a **dimly lit Pad**.

To select the range of transpositions the pads will use, use the **Parameter** ◀/▶ buttons (see the diagrams here).

To adjust the key of the current track down or up, press **Shift** and the **Parameter** ◀/▶ buttons, respectively.

To play the track from the hot cue point, press a **lit Pad**. Each pad corresponds to a specific transposition (by semitones), depending on the current range of transposition (see the diagrams here). The pad with no transposition (the original pitch) will be lit **white**.

Up

+4 semitones	+5 semitones	+6 semitones	+7 semitones
0 (original pitch)	+1 semitone	+2 semitones	+3 semitones

Middle

0 (original pitch)	+1 semitone	+2 semitones	+3 semitones
-4 semitones	-3 semitones	-2 semitones	-1 semitone

Down

-3 semitones	-2 semitones	-1 semitone	0 (original pitch)
-7 semitones	-6 semitones	-5 semitones	-4 semitones

Roll Mode

In Roll Mode, you can press and hold each pad to trigger a “loop roll” of a certain length while the track’s timeline continues (in EngineOS, the lower half of the waveform in the display will continue moving forward). When you release the pad, the track will resume normal playback from where it would have been if you had never done anything (i.e., as if the track had been playing forward the whole time).

1/8-Beat Roll	1/4T-Beat Roll	1/4-Beat Roll	1/2T-Beat Roll
1/2-Beat Roll	1T-Beat Roll	1-Beat Roll	2-Beat Roll

(T denotes a triplet-based time division)

To enter Roll Mode, press **Roll**.

To trigger a roll, press the corresponding pad. Pads with triplet-based loop rolls are indicated are lit with a different color. The time divisions are also displayed on the **Performance Pad Displays**.

Note: Triplet-based time divisions are not available in use with a Computer Input and Serato DJ.

Loop Mode

In Loop Mode, you can use each pad to enable an assigned loop.

Tip: You can use the Engine DJ software to set and name your loops. The names will appear on the **Performance Pad Displays** for reference.

To enter Loop Mode, press **Roll** a second time.

To assign a loop to a pad and enable it while using EngineOS, press an unlit pad to create a Loop In point at the current location, and then press it again to create the Loop Out point at another location. You can also assign an auto loop to a pad by pressing an unlit pad while in the auto loop. The loop will activate immediately, and the pad will light up. When using Serato DJ, use the Loop In/Loop Out buttons, as described in [Looping & Beat-Jumping](#).

To enable a loop, press the corresponding pad. Once a loop has been created, you can also retrigger it by pressing the corresponding pad again, depending on the **Saved Loop Behavior** setting in the [Profile > Cues/Loops](#) menu.

To enable an active loop, press and hold the **Parameter** ◀ button and press a pad with a saved loop. Active loops will begin looping automatically as soon as they are reached, and are shown with a striped pattern in the track waveform. You can also set these in the Engine DJ software.

To delete a loop, press **Shift** and the desired pad.

Sampler Mode

In Sampler Mode, you can assign and trigger up to eight samples using your performance pads.

To enter Sampler Mode, press **Sampler**.

You can view your assigned samples in **Performance View** by enabling the **Performance Pads** option in the **Layout** menu. When the Sampler pad mode is selected, you will see the sample names loaded to each pad in the **Performance Pad Displays**.

Your hardware includes a set of pre-installed sample content, which you can browse from **Library View** when **Sampler Content** is selected as a source.

To load a sample from Library View, partially swipe the sample to the right and tap **Load**, or double-tap the sample. Next, instead of selecting a deck, tap one of the eight sampler slots on the touchscreen. Alternatively, press the hardware pad where you want the sample assigned. If a sample is already loaded to the selected pad, the new sample will replace the existing sample.

You can view assigned samples using the **Performance Pad Displays** while Sampler Mode is activated.

Loaded samples will be retained in memory across device reboots if the same source drive is connected and selected.

To trigger a sample, press the performance pad on the hardware.

The sampler volume can be adjusted using the **Sampler Level** knob on the front panel.

Sampler audio routing can be adjusted using the **Sampler Output** option in the **Settings > Mixer** menu.

To stop a playing sample, hold **Shift** and press the performance pad.

To remove a sample, you must first exit Performance View. Samples cannot be removed while in Performance View to prevent accidental ejection. While in Library View, Settings, or another page, press and hold **Shift** and then press the performance pad with the sample you want to remove. If the sample is playing, you will need to stop it first, and then remove it.

Scratch Bank Mode

Note: Scratch Bank Mode is only available when using Computer Input and Serato DJ Pro.

In Scratch Bank Mode, each pad loads a scratch sample to the selected deck. You can assign the scratch sample and set the starting point in the Serato DJ Pro software. This is useful for preparing and performing with song samples for scratching.

To enter Scratch Bank Mode, quickly double-press the **Sampler** button while using Serato DJ Pro.

Stems Mode

Stems Mode is automatically included with SYSTEM ONE hardware. Track stems can be created directly on SYSTEM ONE, or using the Engine DJ software and packed to an external drive for use with SYSTEM ONE.

Tracks with stems will show a **Stems icon** before the track name. All stemmed tracks can be found in the **Stems** list of [Library View](#) when it is enabled in the [Profile > Library](#) menu (on by default when Stems is activated).

To add a track to the Stems list, partially swipe a track to the left and tap **Stems**. Tracks added to the stems list that have not previously been rendered are processed in the background as you use the SYSTEM ONE and are saved on the current drive for future recall.

Note: To use onboard stems rendering, you must first download the stems processor. The first time you add a track to the **Stems** list, tap **Yes** in the **Download Engine Stems** window to begin downloading the stems processor. You must be connected to the internet to begin the download. You can also begin the download by going to [Settings > Device](#) and tapping the **Add** button next to the **Add Stems Support** setting.

To remove a track from the Stems list, tap the **edit icon** at the top of the display to enter editing mode, and then swipe left on the desired track, or partially swipe left and tap **Remove Stems**. This will remove the track from the stems list and remove the stems themselves.

Adding a stem track to a deck will allow you to use Stems pad mode. This can be accessed from the hardware by pressing the **Stems** button when a stem-enabled track is added to the deck.

When Stems Pad Mode is enabled, the top four pads can be used to isolate stems. From left to right, these pads control **Vocal**, **Melody**, **Bass**, and **Drums**.

To mute a stem, press the pad so it is dimly lit.

To unmute a stem, press the pad again so it is brightly lit.

Press the **ACAPELLA** stems button to activate an instant Acapella, muting the **Melody**, **Bass**, and **Drums** stems to isolate the **Vocal** stem.

Press the **INSTRUMENTAL** stems button to activate an instant Instrumental, muting the **Vocal** stem to isolate **Melody**, **Bass**, and **Drums** stems.

Press the **Stems Level** button to enable using the **Channel EQ** knobs to control the volume level of the stems. The **High EQ** knob adjusts the **Vocal** stem, the **Mid EQ** knob adjusts the **Melody** and **Bass** stems, and the **Low EQ** knob adjusts the **Drums** stem. As the **Channel EQ** knobs are turned, the **performance pads** and **ACAPELLA / INSTRUMENTAL** buttons will respond to indicate the active stems. For example, if the **Vocal** stem is turned all the way down using the **High EQ** knob, the **Vocal** performance pad will dim and the **INSTRUMENTAL** button will become lit.

While **Stem Level** is activated, the **Stem Level** button will flash if the current **Channel EQ** knob position does not match the current Stem Level setting. Moving the knob will initiate a “soft takeover” once the current setting position is reached, and the Stem Level button will stop flashing.

Slicer Mode

In Slicer Mode, the eight pads represent eight sequential beats—“slices”—in the beatgrid. When this mode is entered, the track on screen will display the eight slice divisions. The currently playing slice is represented by the currently lit pad; the light will “move through the pads” as it progresses through the eight-slice phrase. You can press a pad to play that slice. When you release the pad, the track will resume normal playback from where it would have been if you had never pressed it (i.e., as if the track had been playing forward the whole time).

To enter Slicer Mode, press the **Stems** button a second time.

To play a slice, press the corresponding pad.

To decrease or increase the length of the slice divisions, use the **Parameter buttons** (◀/▶).

FX

BPM FX

SYSTEM ONE features built-in, time-based effects that can be selected and controlled using your hardware or touchscreen interface.

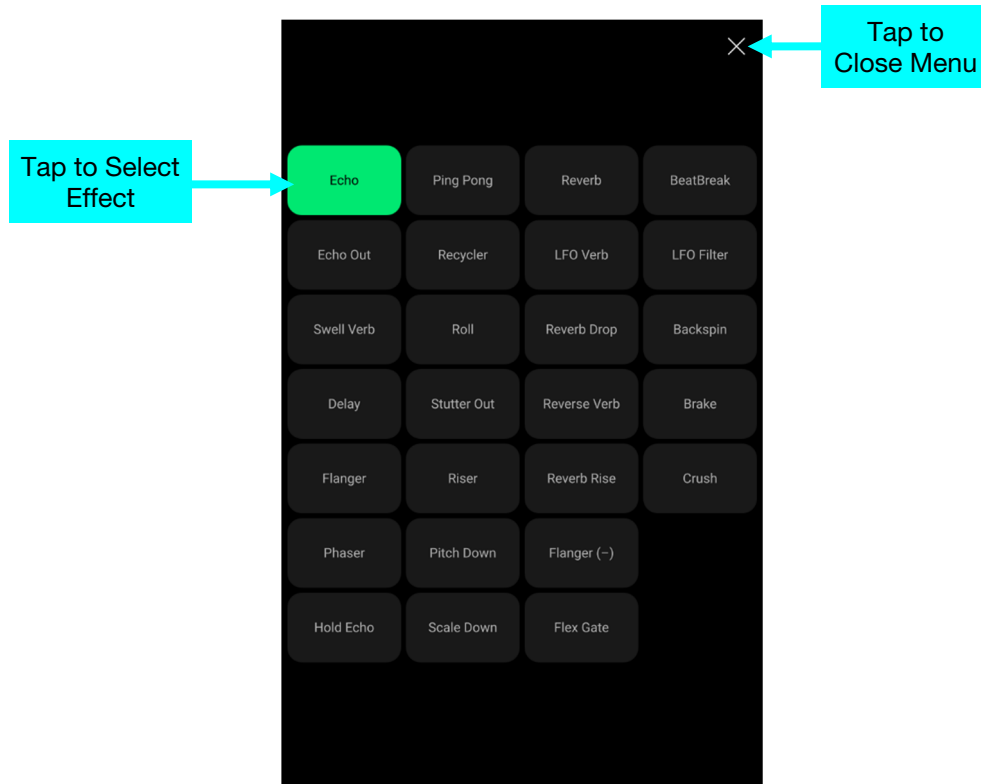

To open the **BPM FX selection menu**, press and hold the **FX Select** buttons on SYSTEM ONE.

To select an effect from the list:

- Tap the desired effect.
- Press the corresponding **FX Select** button on SYSTEM ONE.
- Turn a **Scroll / Load** knob so the desired effect is highlighted, and then press the knob.

Selecting an effect will load it to the selected deck (if available) and close the BPM FX selection menu.

To close the menu without selecting an effect:

- Tap the **X** icon in the upper-right corner of the screen.
- Tap anywhere outside of the effects list.

To adjust the effect parameters, use the additional FX controls on SYSTEM ONE:

- Use the **Parameter** knob to adjust the selected parameter. Press it to change parameters if available.
- Move the **Beats** joystick up or down to increase or decrease the time division.
- Use the **Depth** knob to adjust the amount of FX output signal.

See [Appendix > FX Parameters > BPM FX](#) for more information on the available BPM FX parameters.

Sweep FX

To view and select available Sweep FX, press and hold the **Sweep FX On/Off / Sweep FX Select** button. In the menu that appears, you can select from the following effects:

- Filter:** This effect applies a filter to the channel. Starting from the center (12:00) position, turn a Sweep FX knob counter-clockwise to apply a low-pass filter, or turn it clockwise to apply a high-pass filter. Use the **Resonance** slider to determine the amount of resonance of the filter, from **0** to **15**. Use the **Extreme Type** setting to determine the effect of the Sweep Filter at the extreme low and high ends. Select **Kill** for the filter extremes to end in silence, or select **Bleed** to allow the extreme end of the filter to play.
- Noise:** This effect adds noise to the signal. Starting from the center (12:00) position, turn a Sweep FX knob counterclockwise to add pink noise, or turn it clockwise to add white noise. Use the **FX Noise Volume** setting to determine the level of the Noise Sweep effect in the mix when active, from **-20** to **15 dB**.
- Wash:** This creates a transition effect. Turn a Sweep FX knob to its most counter-clockwise (minimum) position to apply a 1-beat echo that will also mute the channel's normal audio signal, or turn it to its most clockwise (maximum) position to apply a 1/2-beat echo.
- Reverb:** This effect applies reverb to the signal. Turning the Sweep FX knob clockwise or counterclockwise from the center (12:00) position increases the room size of the reverb effect. Turning to the left lowers the pitch of the reverb, while turning to the right increases the pitch.
- Dub Echo:** This effect is a brief echo. Starting from the center (12:00) position, turn a Sweep FX knob counterclockwise to decrease the length of the delay and increase the feedback, or turn it clockwise to increase the length of the delay as well as the feedback.

To minimize the Sweep FX menu, release the **Sweep FX On/Off / Sweep FX Select** button.

To use Sweep FX, turn the Deck 1 or Deck 2 **Sweep FX On/Off / Sweep FX Select** button to enable, and then turn the Sweep FX knobs clockwise or counterclockwise.

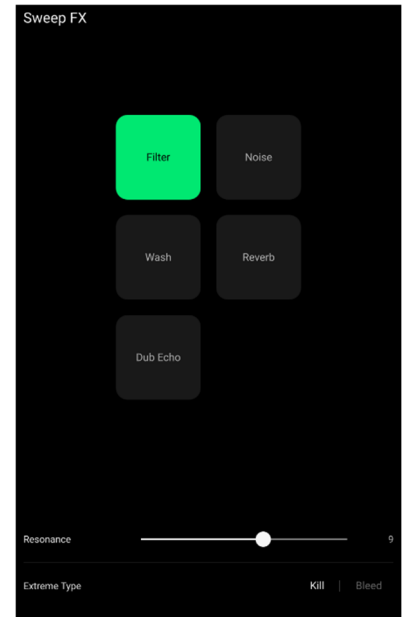

Fader FX

To view and select available Fader FX, press and hold the **Fader FX On/Off / Setup** button. In the menu that appears, you can select the following effects:

- Fader Echo:** This effect applies a short echo when the faders are moved. Use the **Beats** setting to determine the time division value for the echo (**1/4, 1/3, 1/2, 3/4, 1, 3/2, 2, or 4** beats). Use the **Feedback** slider to determine the amount of Fader Echo effect signal fed back into the delay line, extending the length of repeats (**0–100%**).
- Echo Down:** This effect applies a short echo with a pitch down effect when the faders are moved. Use the **Beats** setting to determine the time division value for the echo (**1/16, 1/8, 1/4, 1/3, 1/2, 3/4, 1, or 2** beats). Use the **Feedback** slider to determine the amount of Echo Down effect signal fed back into the delay line, extending the length of repeats (**0–100%**).
- Stutter Verb:** This effect applies a stutter effect with reverb when the faders are moved. Use the **Pattern** setting to determine the stutter pattern used for the effect (**1–6**). Use the **Depth** setting to determine the size of the reverb (**0–100%**).
- Reverb Down:** This effect applies a wind down effect with reverb when the faders are moved. Use the **Length** slider to determine the length of the effect (**0–100%**).

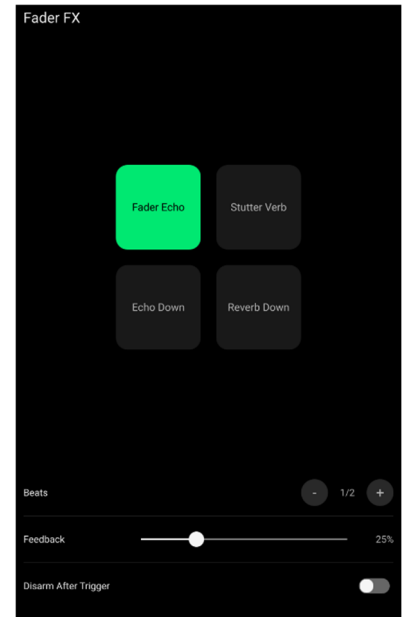

For all Fader FX, use the **Disarm After Trigger** setting to determine whether Fader FX is automatically disabled after it is triggered, or if it remains enabled.

To minimize the Sweep FX menu, release the **Fader FX On/Off / Setup** button.

To use Fader FX, quickly move a **Channel Fader** down or the **Crossfader** to the opposite side.

Touch FX

The Touch FX feature allows you to control ten powerful audio effects via the touchscreen to create buildups, drops, and transitions with a single touch.

To access Touch FX, press the **Touch FX** button.

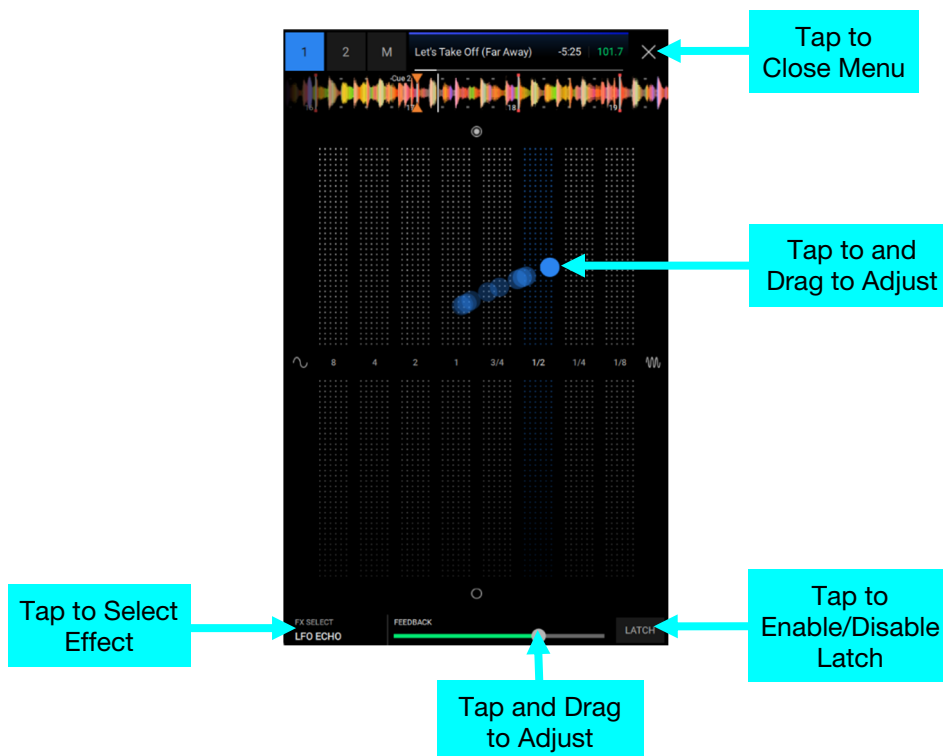

Touch FX can be applied to a single deck at a time, or to the main output (affecting both decks). Tap the deck number (1 or 2) in the upper-left corner of the screen to select the desired deck, and the track name, time, BPM, and waveform overview will be shown. Alternatively, tap **M** to select the main output.

Each effect has a pair of parameters, one mapped up and down and one mapped left and right, that can be continuously adjusted by tapping and dragging your finger around the center area. See [Appendix > FX Parameters > Touch FX](#) for more information on the available Touch FX parameters.

To change the current effect, use the **FX Select** menu in the bottom-left corner of the screen to select from the following options:

- LFO Echo
- Filter Roll
- Filter Echo
- Filter Dub Echo
- Filter Gate
- Noise Gate
- Filter Reverb
- Flanger
- LFO Filter
- Filter

To adjust an additional effect parameter, such as a **Feedback** or **Resonance** control, use the slider at the bottom of the screen.

To hold the current position of the Touch FX, tap the **Latch** button at the bottom-right of the screen. The **Touch FX** button will flash and the effect will remain in any position you move it to until Latch is turned off. Latch will automatically turn off if you switch active decks or change FX selection while it is enabled.

To close Touch FX and return to the previous screen, press the **Touch FX** button again, or tap the **X** icon in the upper-right corner of the screen.

Mixer

To open the **Mixer menu**, press the **Global > Mixer / EQ** button on the right deck.

Channels

In this tab, you can select the active Input for Channel 1 and Channel 2.

Tap the **drop-down** menu for each channel, and then select **Engine** for standalone use with connected drives, or select **Computer** for use with connected DJ software or streaming audio from a connected computer.

Press the **Advanced** button at the bottom of the screen to open the **Settings > Mixer** menu for more device settings.

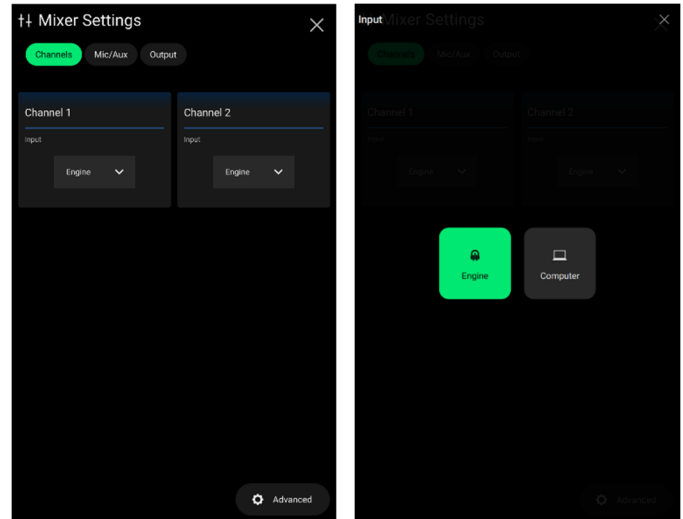

Mic/Aux

In this tab, you can adjust settings for the microphone and aux audio.

- **Send To:** This setting allows you to route the microphone and aux signals to the **Booth** and/or **Headphones** outputs. Tap to select each one.
- **Anti-Feedback:** Enable this option to apply anti-feedback processing to the microphone audio.
- **Mic FX:** This setting allows you to enable either an **Echo** or **Reverb** effect to the microphone.

When **Echo** is selected:

- o **Echo Feedback** controls the amount of echo signal fed back into the delay line.
- o **Echo Speed** controls the rate of echo delays.

When **Reverb** is selected:

- o **Reverb Room Size** adjusts the length of the reverb tail.

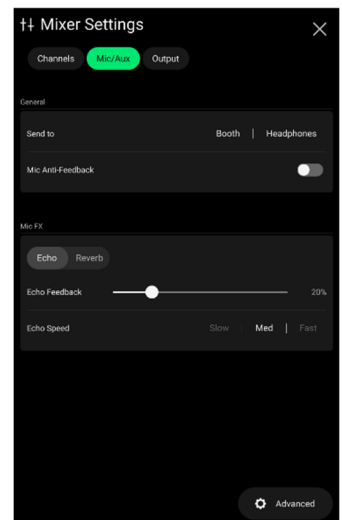

Press the **Advanced** button at the bottom of the screen to open the **Settings > Mic / Aux** menu for more device settings.

Output

In this tab, you can apply and adjust EQ curves for the **Main** and **Booth** outputs.

Tap **Main** or **Booth** to view the EQ curve for the selected output.

Tap the **switch** in the upper-right corner to enable EQ for the selected output.

Tap and drag on each **Frequency marker** to boost or attenuate the selected frequency.

To reset the EQ curve, tap the **Reset** button. Customized EQ settings are retained between power cycles.

Use the **Main VU Meter** setting to determine whether SYSTEM ONE's **Main Level Meters** display the audio signal level **Pre** fader level or **Post** fader level.

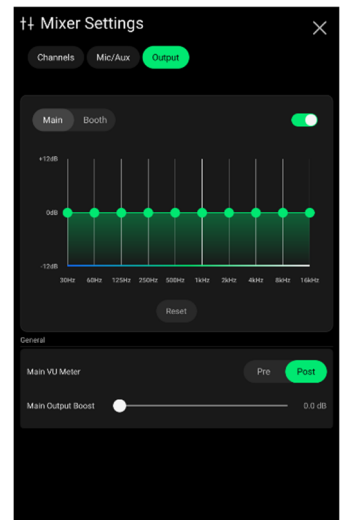

Record

To open the **Record** menu, press the **Global > Record** button on the right deck.

Select the media device destination that you will use to save your recording. The currently selected source device will show **Source** next to its name. Once you have selected the recording device, you can begin recording your session.

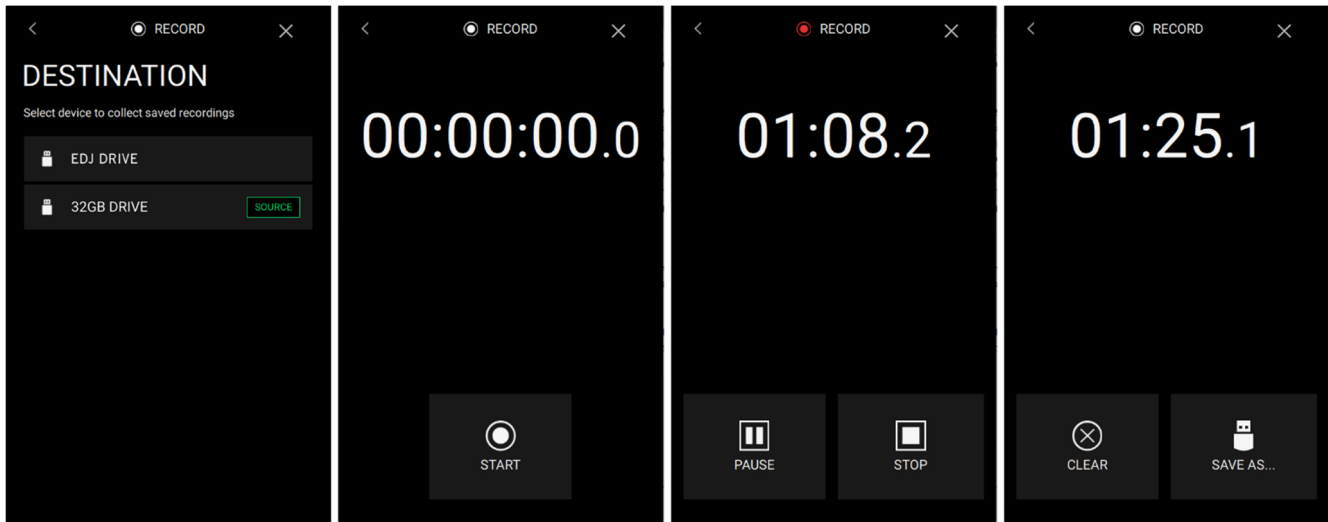

To begin recording, tap **Start**. The timer on the touchscreen will show the total length of time recorded.

To pause recording, tap **Pause**.

To resume recording when paused, tap **Resume**. SYSTEM ONE will continue recording your session from where you pressed pause.

To stop recording, tap **Stop**. Once recording is stopped, you will have the option of saving the file to your device.

To clear the recording, tap **Clear**. A warning screen will be shown before the file is deleted. Tap **Yes** to continue, or **No** to return to the previous page to save the recording.

To save the recording to your drive, tap **Save As**.

A keyboard will appear where you can title your file. Tap **Done** to finish and save your file, or tap **Cancel** to return to the previous page.

You can also use the **Maximize Recording Volume** option to normalize your audio recording at -1 dBFS. This may take some time, depending on the length of your recording. This option is enabled by default.

A success message will be shown on the display when the operation is complete. Tap **OK** to continue, or wait a few seconds and you will be returned to the Record menu.

Recorded files will be saved in a folder called **Sessions** on your media device. You can access these recordings from SYSTEM ONE under the **Files** section of the **Library**.

To move back a page or return to the previous page, tap the **back arrow (<)**. If you exit the Record menu while recording is active or paused, the record status and time elapsed will be displayed in the **Toolbar**, and the **Record** button will flash.

To exit the Record menu, tap the **X**.

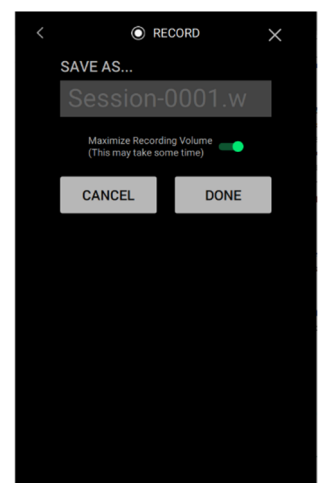

Control Center

Press the **Menu** button or **swipe down from the toolbar** to open the Control Center. Here, you can quickly adjust commonly used **Parameters** using the widgets in the center of the screen. You can also access the following pages. Click the links below to jump to that part of the guide:

- **Layout** – This screen is used to adjust the appearance of SYSTEM ONE.
- **Profile** – This screen is used to edit your performance and library preferences.
- **Settings** – This screen is used to edit the settings of SYSTEM ONE.
- **Source** – This screen is used for selecting your source media device.
- **Wi-Fi** – This screen is used for connecting to and configuring your Wi-Fi network.
- **Bluetooth®** – This screen is used for linking to and configuring Bluetooth devices.
- **Engine Lighting** – This screen is used for working with the SoundSwitch Engine Lighting integration.

Tap the **X** in the upper-right corner of the screen to exit the Control Center. Alternatively, press **Back** or swipe up from the bottom of the screen.

Parameters

Continue: Tap this to enable or disable continuous playback, which will keep playing the next track when the active track has ended.

Beat Grid Edit: Tap this to access beat grid editing from the touchscreen. See [Beat Grid Editing](#) for more information.

X Fader: Tap this to enable or disable the crossfader.

Bluetooth Device Volume: Use this slider to adjust the volume level of a connected Bluetooth audio device input. See [Bluetooth®](#) for more information.

Ableton Link: Tap this to enable Ableton Link sync mode. You can also enable this and adjust the Offset time in the [Settings > Services](#) menu.

Day Mode: Tap this to enable or disable Day Mode. This mode inverts the colors of the SYSTEM ONE interface for better visibility in bright daylight environments.

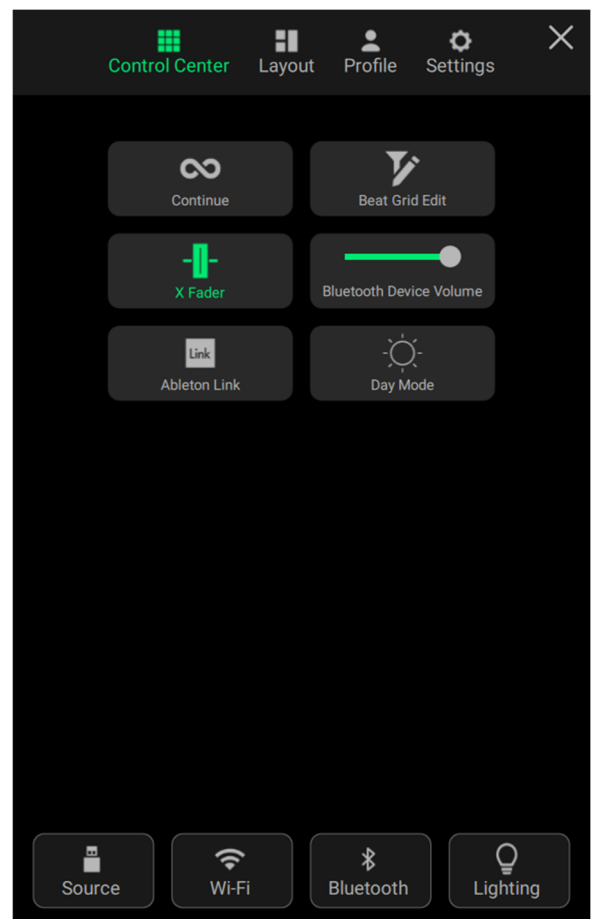

Layout

Use the **View 1–3** buttons to select a saved layout preset, and then use the options below to configure it. You can cycle between these options by pressing and holding **Shift** and pressing the **Menu** button on SYSTEM ONE.

Press the **Reset Current View** button to reset the selected layout preset to its default configuration.

Performance Layout

- **Waveform Orientation:** Use this option to select whether the track waveforms are in **Horizontal** or **Vertical** display in Performance View. The waveforms will also change in size based on other components on screen in each layout, including the Performance Library, Main FX, or Track Artwork.
- **Performance Library:** Tap this to enable or disable the Performance Library from appearing in Performance View.
- **Display Album Art:** Tap this to enable or disable track album art from appearing in Performance View.
- **Main FX:** Tap this to enable or disable **BPM Effects** from appearing in Performance View. When enabled, the FX selection and parameters will be shown at the bottom of the touchscreen. When disabled, the FX selection and parameters are not shown on the touchscreen, but can still be used with the hardware controls. See [BPM FX](#) for more information.

Profile

Press the **Log In** button to log in to your Engine DJ profile. Once you are logged in, you can access crowd-sourced streaming metadata and beat grid information, and automatically connect to associated streaming and cloud services. Existing streaming and cloud service logins will be removed, and any tracks loaded to a deck will be ejected. To manage your connected services, visit enginedj.com and log in to your account.

Press the **Save To My Drive** button to save your settings to a connected drive. User profiles can be loaded when a media device with an Engine DJ profile is connected to SYSTEM ONE.

Playback

- **Motorized Platter Start:** This setting determines how quickly your track starts to play. When set to **Normal**, the track will play in relation to the motor start-up speed. When set to **Instant**, the song will begin immediately, and the motor and platter will catch up to the song within a few milliseconds.
- **Motor Torque:** This setting determines the torque level of the motorized platter (**Low, High**).
- **Track Speed:** This setting determines the speed at which the track plays (**33 RPM, 45 RPM**).
- **Turntable Mode:** When set to **On**, this mode allows the motorized platter to keep spinning after a track ends, just like a standard turntable. When set to **Off**, the motorized platter will stop after the track ends.
- **Track Start Position:** This setting determines where the beginning of a track is after it loads. Select the actual start of the file (**Track Start**) or the automatically detected beginning of an audio signal (**Cue Position**).
- **Maintain Play State on Load:** When enabled, loading a new track will automatically enter the play state of the previous track on the deck where it was loaded. For example, if a track was already playing, the new track will begin playing as soon as it loads. When disabled, tracks will always load with playback paused.
- **Censor Button Behavior:** This setting determines the default push behavior of the **Censor** button. When set to **Censor**, press it to reverse playback of the track, but when released, normal playback will resume from where it would have been if you had never engaged the Censor feature (i.e., as if the track had been playing forward the whole time). When set to **Silent Cue**, press the button to temporarily mute the deck audio until a Hot Cue or Pitch Play pad is pressed. This allows you to play a track from the desired position and unmute the deck with a single button press.
- **Acapella/Instrumental FX:** This setting determines whether the **Stem FX** function is the **Primary** function of the **Acapella** and **Instrumental** buttons (normal button press) or the **Shift** function of the **Acapella** and **Instrumental** buttons (default, **Shift** plus button press).
- **Default Speed Range:** This setting determines the range of the **pitch fader**. Select **±4%, 8%, 10%, 20%** or **50%**.
- **Sync Mode:** This setting determines the degree of synchronization applied when you press the Sync button on SYSTEM ONE:
 - **Bar:** The tempo will be synced, and the track will be automatically bar-matched with the track on the sync lead deck (the downbeats of each bar will be aligned).
 - **Beat:** The tempo will be synced, and the track will automatically beat-matched with the track on the sync lead deck.
 - **Tempo:** Only the tempo will be synced (the BPM will match that of the sync lead deck).
- **Sync Button Action:** This setting determines how the **Sync** button will act when pressed.
 - **Toggle:** This mode allows you to toggle sync on and off without having to hold **Shift**.
 - **Shift Disable:** This mode requires **Shift** to be held in order to turn off sync.
- **Pitch Control Type:** This setting determines the primary function of the Pitch Bend buttons. Select **Pitch Bend** to keep the primary function as momentarily reducing or increasing the pitch, or select **Range** to set the primary function to adjusting the range of the pitch fader. The function not used as the primary will still be available by holding **Shift** and using the **Pitch Bend** buttons.
- **Pitch Bend Behavior:** This setting determines the behavior of the **Pitch Bend** button function. When set to **Fixed**, pressing and holding the **Pitch Bend** buttons changes the speed of the track at a consistent rate. When set to **Progressive**, the longer the **Pitch Bend** buttons are held, the greater the rate of speed change.
- **Key Sync Mode:** This setting determines whether key syncing is **Strict** or **Fuzzy** (default). When set to **Strict**, tracks will only be key synced to the same or relative key (i.e., 7a to 7b). When set to **Fuzzy**, the available compatible keys are increased to include relative keys of the dominant and subdominant keys of the lead track, decreasing the amount of pitch shifting necessary to match two tracks together.

Cues/Loops

- **Cue/Loop Quantization:** This setting determines the degree of quantization for time-based features. Select **1/8** beat, **1/4** beat, **1/2** beat, **1** beat or **4** beats.
- **Paused Hot Cue Behavior:** This setting determines how pads will play their hot cue points. When set to **Momentary**, playback will start from a hot cue point when you press and hold its pad—release the pad to return to the hot cue point. When set to **Trigger**, playback will start from a hot cue point (and continue) when you press and release its pad.
- **Default Loop Size:** This setting determines the default size of an auto loop when you load a new track to the deck: **None**, **1**, **2**, **4**, **8**, **16**, or **32** beats.
- **Default Beat Jump Size:** This setting determines the default size of the beat jump when you load a new track to the deck: **None**, **1**, **2**, **4**, **8**, **16**, or **32** beats.
- **Smart Loops:** This setting determines whether or not a manual loop will be automatically expanded or reduced to a conventional length (e.g., 2 beats, 4 beats, 8 beats, etc.) when you set it. Select **On** or **Off**. This setting works independently of the quantization setting.
- **Move Cue To Loop In:** This setting determines whether the song's **Cue Point** will automatically be moved to the start of a loop (**On**), or remain at its current point (**Off**).
- **Saved Loop Behavior:** This setting determines the action of loops after they have been saved. When set to **Reloop**, pressing a pad with a saved loop will start playing the loop again. When set to **Disable**, pressing a pad with a saved loop will turn off the loop.
- **Paused Saved Loop Behavior:** This setting determines the action of saved loops that are paused. When set to **Trigger**, pressing a pad with a saved loop on a paused track will trigger track playback from the point of the active loop. When set to **Enable**, pressing a pad with a saved loop on a paused track will move the playhead to the start of the loop, but the track will remain paused.

Display

- **Reset Played Tracks:** Click **Reset** to reset the played status of all tracks.
- **Track Title:** This setting determines whether tracks titles are shown as the track's **Filename** or its embedded **Metadata** (tags).
- **Time Format:** This setting determines whether or not pitch adjustment affects how the track time is displayed. When set to **Static**, the track's time corresponds to locations in the track as usual; adjusting the pitch does not affect it. When set to **Dynamic**, the track's time will automatically adjust to account for changes in pitch. For instance, if you set the pitch fader to **-8%**, the track time will increase so it is 8% longer.
- **Track End Warning:** This setting determines how long before the end of a track that SYSTEM ONE will warn you it is nearing the end. Once this time is reached, the **track overview** will flash.
- **Waveform Style:** This setting determines the appearance of track waveforms. Select **Tri-Band** for Engine OS waveforms where blue represents bass, green is mid-range, and white is treble. Select **RGB** for software-style waveforms where red represents bass, green is mid-range, and blue is treble.

Note: RGB waveforms and track overviews will be built when loading a track to a deck. Alternatively, you can use Engine DJ software to **Analyze: Get missing analysis data** and reimport your tracks with RGB waveforms.

Safety

- **Lock Playing Deck:** This setting determines whether or not you will be able to load a track to the deck as it is playing. Select **On** or **Off**. When this setting is on, the deck must be paused in order to load a track to it.
- **Needle Lock:** This setting determines whether or not you can tap the **track overview** in the display to jump to that location in the track during playback. Select **On** or **Off**. You can use the track overview while playback is stopped regardless of this setting.
- **Pad Lock:** This setting determines whether the pads and pad mode buttons are always enabled (**Off**) or disabled (**On**). When disabled, the pads and pad mode buttons will not be lit.
- **Key Adjust:** This setting determines whether the **Key Adjust** ◀/▶ buttons operate on a short-press (**Normal**) or **Long Press**. When Long Press is selected, holding a **Key Adjust** button will adjust the key of the playing track, and subsequent presses will trigger Key Adjust without having to hold. After a three-second time out, a long press is again required to trigger key adjust.

Library

- **Stems List:** Use this option to enable or disable the **Stems** list from appearing in Library view.
- **Key Notation:** This setting determines how the track key is notated in the display. You can view the key as all **Sharps**, all **Flats**, **Open Key**, or **Camelot**.
- **Key Filter:** This setting determines whether the **Key** filter shows tracks with the same key only (**Match**) or tracks with compatible keys (**Compatible**).
- **BPM Range:** This setting determines the lowest- and highest-possible BPM values that will be used when tracks are analyzed: **58–115**, **68–135**, **78–155**, **88–175**, or **98–195 BPM**.
- **BPM Filter Tolerance:** This setting determines the “tolerance” of the **BPM** filter so you can include tracks with tempos that are within a small range of the selected tempo. Select **±0**, **1**, **2**, **3**, **5**, **10**, or **15**.
- **Collection Browse Behavior:** This setting determines browsing behavior when using the Library. When set to **Select**, tapping a playlist or folder will select it, and a double-tap is required to open it. When set to **Open**, tapping a playlist or folder will open it.

Deck Colors

To change the deck color, tap the color box under the name of the deck, and then tap the color to select.

Settings

Device

- **Wi-Fi:** This determines whether Wi-Fi connectivity is enabled (**On**) or disabled (**Off**). Tap the **gear icon** to open the Wi-Fi settings. See [Wi-Fi](#) for more information about the Wi-Fi menu.
- **Bluetooth:** This determines whether Bluetooth connectivity is enabled (**On**) or disabled (**Off**). Tap the **gear icon** to open the Bluetooth settings. See [Bluetooth](#)® for more information about the Bluetooth menu.
- **Add/Remove Stems Support:** Click **Add** to download the stems processor for onboard stems rendering. You must be connected to the internet to download the stems processor. Tap **Yes** to continue, or **No** to cancel. Visit enginedj.com/stems for more information. If you have already added stems support, tap the **Remove** button to remove it from your device.
- **Time/Date:** This displays the current local time and date. Tap **Sync Time** when connected to the internet to automatically sync the time.
- **24 Hour Clock:** This setting determines whether the **Time** uses the 12 Hour Clock (**Off**) or 24 Hour Clock (**On**).
- **Time Zone:** Displays the current time zone, formatted as **Region / City**.
- **Set time zone manually:** Enable this setting and then tap the **gear icon** to manually set your local time zone.
- **Playhead Position:** Use this slider to set the position of the playhead along the track waveform in Performance View.
- **Hide Title/Artist:** Use this setting to enable “trainspotting mode,” which hides the Track Title and Artist from decks in Performance View.
- **Track Preview:** When active, Track Preview will reveal a play button for each song in the library, allowing the songs to be auditioned in the cue without loading a song to the deck. Select **On** or **Off**. When **On**, track preview audio will be routed to the active deck when no tracks are loaded. When tracks are loaded, the preview audio will be routed to the inactive deck.
- **Preview Volume:** Use this slider to set the volume level of the track preview (**0–100%**).
- **Screen Saver Time:** This determines if and when the screen saver will turn on after no activity for the selected time: **Off**, **15 mins**, **30 mins**, **60 mins**. While the screen saver is active, the touchscreen display will dim. Interact with the screen or any hardware control to exit the screen saver.
- **Screen Brightness:** This setting determines the brightness of the main display: **Low**, **Mid**, **High**, or **Max**.
- **Encoder Behavior:** This setting determines the default behavior when turning the **Scroll / Load** knobs while in Performance View. When set to **Open Library**, turning the **Scroll / Load** knobs will open Library View. When set to **Waveform Zoom**, turning the **Scroll / Load** knobs will adjust the zoom level of the waveforms in Performance View.

Mixer

- **Sampler Output:** This setting determines where Sampler audio is routed: **Ch 1**, **Ch 2**, or **Main**.
- **Playlist Deck Crossfade Time:** Use this slider to adjust the amount of crossfade between tracks when using the playlist deck.
- **EQ Type:** This setting determines the type of equalization for the **Channel EQ** knobs. Select **Isolate** for EQ bands with infinite cut for full band “kills,” or select **Normal** for EQ bands with limited cut.
- **ISO EQ High Xover:** When EQ Type is set to Isolate, this setting determines the crossover frequency between the Mid and High EQ bands, from **1000** to **8000 Hz**.
- **ISO EQ Low Xover:** When EQ Type is set to Isolate, this setting determines the crossover frequency between the Low and Mid EQ bands, from **100** to **800 Hz**.
- **Smart Headphone Cue:** This setting enables or disables smart headphone cueing. When set to **On**, once a track is loaded to a deck the headphone cue will automatically be switched to that deck. When set to **Off**, cue must be manually set.
- **Cue Solo Mode:** This setting determines how many channels can be sent to the cue mix. Set to **On** to have only one channel at a time in the cue mix, or set to **Off** to cue multiple channels at a time.

- **Split Cue Output:** This setting determines the stereo positioning of the pre-fader cueing mix and main mix when Split Cue is enabled. When set to **Normal**, the pre-fader cue mix will be stereo left and the main mix will be stereo right. When set to **Invert**, the pre-fader cue mix will be stereo right and the main mix will be stereo left.
- **X-Fader Cut In Length Left/Right:** Use the sliders to adjust the amount of dead space between the left and right side of the crossfader's closed and open positions.
- **Calibrate Crossfader:** Tap **Calibrate** and then follow the directions on the touchscreen to calibrate your crossfader.

FX

- **Effect Select Behavior:** When set to **Default**, all effects settings will return to their default settings when a new track is loaded. When set to **Recall**, effects settings will be retained.
- **Reset Effects to Default Settings:** Tap here to manually reset effects to the default settings.

Mic / Aux

- **Mic 1/2 Attenuation:** These settings determine the amount of additional attenuation for the **Microphone 1** and **Microphone 2 Inputs**, from **-15** to **0 dB**.
- **Talkover Threshold:** This setting determines the minimum threshold at which the microphone signal will activate, from **-40** to **-1 dB**.
- **Aux EQ:** These settings allow you to adjust the **Treble**, **Mid**, and **Bass** equalization for the aux signal, from **-15.0** to **6.0 dB**.

Services

- **Engine Lighting:** This determines whether SoundSwitch Engine Lighting is enabled (**On**) or disabled (**Off**). Tap the **gear icon** to open the lighting control interface.
- **Sync:** This determines whether Ableton Link is enabled (**On**) or disabled (**Off**). Ableton Link synchronizes beat, phase, and tempo of Ableton Live and Ableton Link-enabled applications over a wireless or wired network. All Link-enabled devices must be connected to the same local network.

Use the **Ableton Link Offset** slider to compensate for phase effects. You can adjust the offset between **-200** and **200 ms**.

- **Streaming:** Use these options to enable or disable connections to streaming service partners. When set to **On**, the selected service will be available in the **Source** menu.
- **Cloud:** Use this option to retrieve your Engine library database from a cloud storage service. You must first use the Engine DJ software to back up your database. Then, when this option is set to **On**, the selected service will be available in the **Source** menu and you can access these files over an established internet connection.

Note: We recommend using only high-quality, name brand USB 3.0 or Class U1 or U3 SD cards as source drives, especially when cloud services are enabled.

About / Update

This page displays the product name, current firmware version, and other device information.

- **Firmware Update Mode:** If you are not running the latest firmware, tap **Options** to restart SYSTEM ONE in Update Mode, which enables you to update its firmware. Follow the firmware update instructions included with the firmware update package you downloaded.
- **Send Anonymous Usage Statistics:** This determines whether or not your usage statistics will be sent occasionally to us, enabling us to improve the Engine experience.
- **Legal:** Tap here to view the inMusic Brands EULA and patent list.
- **Factory Reset:** Tap here to restore the default factory settings for your device.

Source

The Source menu allows you to select a connected media device, streaming service, or cloud service, or computer input for DJ software such as Serato DJ for use with SYSTEM ONE hardware.

When the Source menu is open, all connected media sources are shown in the top part of the display. New sources that are available to connect to are shown at the bottom of the display.

To open the Source menu, press the **Source/▲** button, or select it from the **Control Center**.

To select a drive as a media source, tap the device name. The currently selected source device, if any, will be outlined. The currently selected recording device, if any, will show a **Rec icon** next to its name.

To select a streaming or cloud service as your source, tap the streaming or cloud service name. If you have not set up a connection to the service yet, you may be prompted to sign in with your username and password or given a web link and code in order to activate your device. Once signed in or activated, you can use the streaming or cloud service to browse and add tracks. Streaming and cloud services may be enabled or disabled in the **Settings > Services** menu.

Note: Connection to Amazon, Apple Music, Tidal, and SoundCloud must be enabled using your Engine DJ Profile, at enginejdj.com.

Both Apple Music and Amazon Music can download up to one track at a time. Amazon Music allows for simultaneous streaming of up to two tracks, including tracks loaded to decks or previewed from the library. Apple Music allows for simultaneous streaming of up to four tracks.

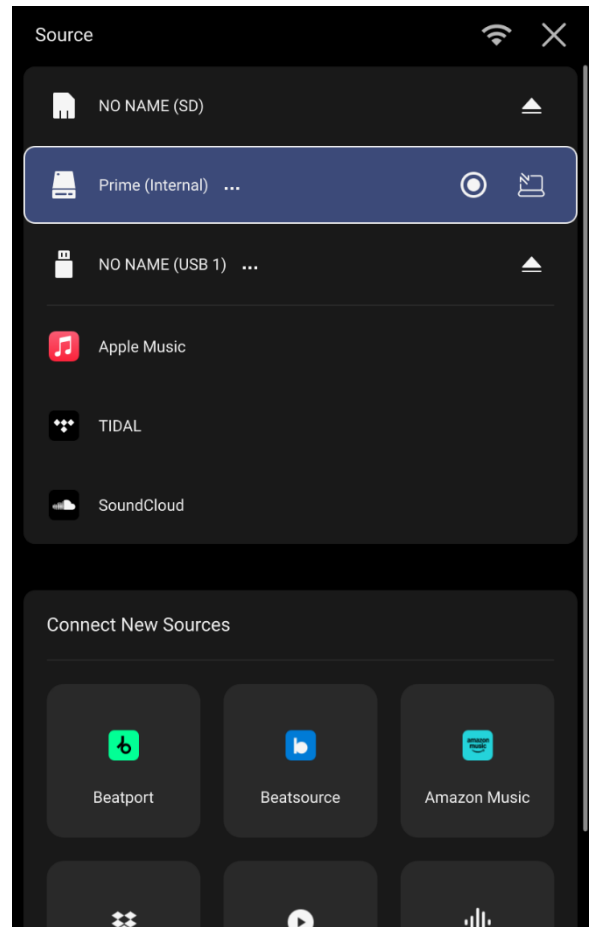

To open Wi-Fi connection menu, tap the **Wi-Fi icon** at the top of the display.

To access the internal SATA drive using a computer connected via USB:

1. Tap the **computer icon** next to your internal drive name in the list of sources.
2. In the **Access Device Storage** window that appears, tap **Continue** to stop track playback and safely eject the internal drive from SYSTEM ONE. It will then proceed with mounting the drive to your connected computer. This process may take a few seconds.

Note: While in Device Storage mode, SYSTEM ONE is not available for playback.

3. Once mounting is complete, the drive will appear as an external drive on your computer. You can now use Engine DJ to transfer analyzed music to it, or transfer files directly from your file browser.
4. To exit Device Storage mode, first safely eject the internal drive from your computer. Then, tap **Exit Mode** on the SYSTEM ONE touchscreen.

To eject a drive source, tap the eject icon next to the drive name. If a track from the selected source is currently in use, an alert will appear to note that the tracks will be unloaded. Tap **Eject Anyway** to continue or tap **Cancel** to return to the Source menu.

Note: An internal drive cannot be ejected from SYSTEM ONE.

To save a source to the Playlist A/B/C banks, highlight the source using the **Scroll / Load** knobs and then press and hold one of the **Playlist A/B/C** buttons. The selected source will be saved to the bank. While viewing the Source menu, you can then quickly select saved sources by pressing the **Playlist A/B/C** buttons.

To remove a saved source, press and hold **Shift** and press the **Playlist A/B/C** buttons.

Note: Source saving, recalling, and removing only works while viewing the Source menu. In all other views, the **Playlist A/B/C** buttons only function as playlist banks.

To exit the Source menu, tap the **X** at the top-right of the display.

Engine Remote Library

In addition to connected devices, streaming services, and cloud services, you can also connect to an instance of the Engine DJ software running on a computer sharing the same network as SYSTEM ONE. This allows you to browse and load tracks from your complete library without having to pack files to a portable drive.

To access your Engine Remote Library:

1. First, make sure your hardware and your computer are on the same network, and the Engine DJ software is opened. This can be done by connecting to the same Wi-Fi network, or by connecting directly using an Ethernet cable.
2. Tap the **Source** icon in Library View from your hardware, and locate your computer under the list of available sources.
3. Tap to select the computer, and your hardware will show “Waiting for confirmation” while another message appears in the Engine DJ software asking to accept or deny access to your hardware. Click **Accept** to approve and continue. If the connection process is canceled, or if the connection is lost, both libraries will return to their previous selections.
4. Once the connection is established, you will be able to browse and load tracks from your Engine DJ software collection directly from your hardware.
5. When you load a track from the Engine Remote Library, the track will begin downloading over the network. The download progress will be shown on your hardware touchscreen. If the download fails, a “Failed to Download” message will appear on your hardware. You can remotely load tracks up to 250 mb in size.

Tracks will download with any performance data associated with the file in your Engine DJ software collection. This includes beat grids, saved cues, and saved loops. If no beat grid information is included with the downloaded track, SYSTEM ONE will analyze the file once it is loaded.

Any edits made to performance data, track metadata, and playlists from SYSTEM ONE or Engine DJ software will automatically sync to the other.

Wi-Fi

The Wi-Fi page allows you to connect to a local internet network so you can browse connected streaming and cloud services.

To enable Wi-Fi, tap the **Wi-Fi switch** at the top of the page. Once enabled, a list of local networks will appear on the display. You can also enable Wi-Fi from the [Settings > Device](#) menu.

To establish a connection, tap the desired network name. If a password is required, you will be prompted to enter it. Once a connection is established, **Connected** will appear next to the network name.

To view information about the network, tap the **three-dots icon** next to the network name. Tap **Close** or anywhere outside the menu to close the Wi-Fi information menu.

A Wi-Fi connection menu will also appear when SYSTEM ONE is powered on. On this page:

To enable Wi-Fi, tap the **Wi-Fi switch** at the top of the touchscreen.

To establish a connection, tap the desired network name. If a password is required, you will be prompted to enter it. Once a connection is established, the page will be dismissed.

To view information about the network, tap the three-dots icon next to the network name.

To dismiss this page, tap **Next** at the top of the touchscreen.

To prevent this page from appearing each time your hardware is powered on, tap the **Do not show again at startup** box so it is checked.

Bluetooth®

The Bluetooth page allows you to connect to a Bluetooth audio input for streaming, a Bluetooth audio output, or a Bluetooth keyboard for searching tracks.

To enable Bluetooth, tap the **Bluetooth switch** at the top of the page. Once enabled, a list of available devices will appear on the display. You can also enable Bluetooth from the [Settings > Device](#) menu.

To link to an available device:

1. First, make sure your Bluetooth device is powered on, in range, and available for pairing. You should see the name of your device in the **Available Devices** list if it is ready to pair.

2. Select your device from the list of **Available Devices**. The first time you connect a device, you will be prompted with a passcode to confirm on both SYSTEM ONE and the Bluetooth device.

Alternatively, for audio input devices such as smartphones or tablets, navigate to the Bluetooth Settings screen on your device. Then, locate SYSTEM ONE and select it.

3. Once successfully linked, your device will appear in the **Linked Devices** list. You can then easily reconnect to this device at any time.

SYSTEM ONE will automatically determine whether your device is used as an input or output. If your device supports both, a dialog will display to ask you to select one type. You can change this at any time using the **three-dots icon**.

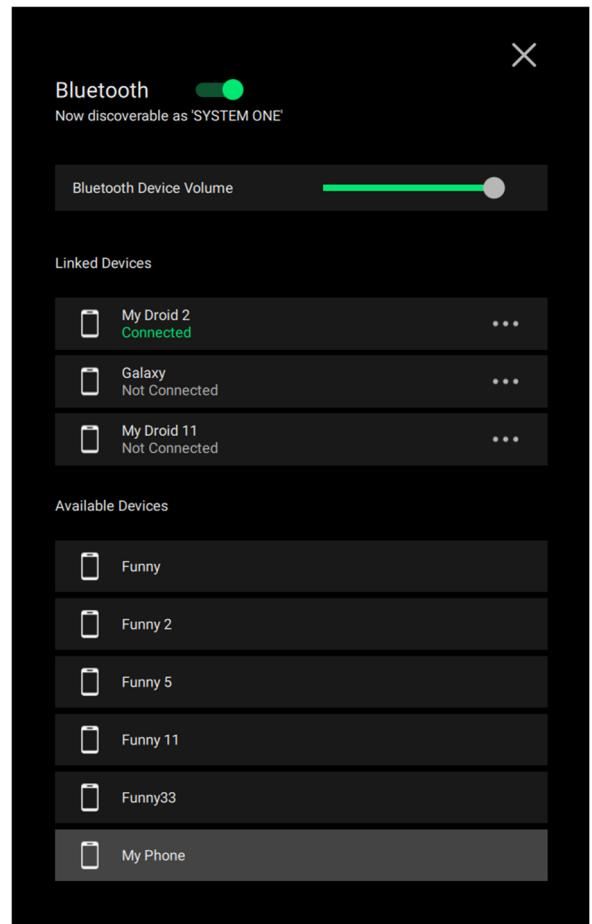

To view device settings, tap the **three-dots icon** next to the device name.

The **Auto Connect** setting determines how your devices reconnect. When this setting is **On**, a device you have previously paired with SYSTEM ONE will automatically reconnect when Bluetooth is enabled and the device is in range. When set to **Off**, you will need to manually reconnect each time.

The **Status** field displays the current connection status.

The **Connection** field allows you to manage your device connection. Tap **Disconnect** to unlink from a connected device. Tap **Forget** to remove a device from the **Linked Devices** list.

Tap **Close** or anywhere outside the window to close the Bluetooth device settings window.

Use the **Bluetooth Device Volume** slider to adjust the Bluetooth device audio input level.

When paired to an audio output device, use the **Main Level** control to adjust the output volume.

Engine Lighting

The Engine Lighting page allows you to control connected lighting devices such as DMX fixtures and Smart Lights using SoundSwitch to seamlessly sync your music and lights.

To open the Engine Lighting control page, enable **Engine Lighting** within the **Settings > Services** menu, and then tap the **gear icon**. You can also tap the **Lighting icon** at the bottom of the Control Center.

To configure the Engine Lighting settings, tap the **Preferences** menu at the top of the touchscreen.

Visit soundswitch.com for more information on using SoundSwitch lighting controls with SYSTEM ONE.

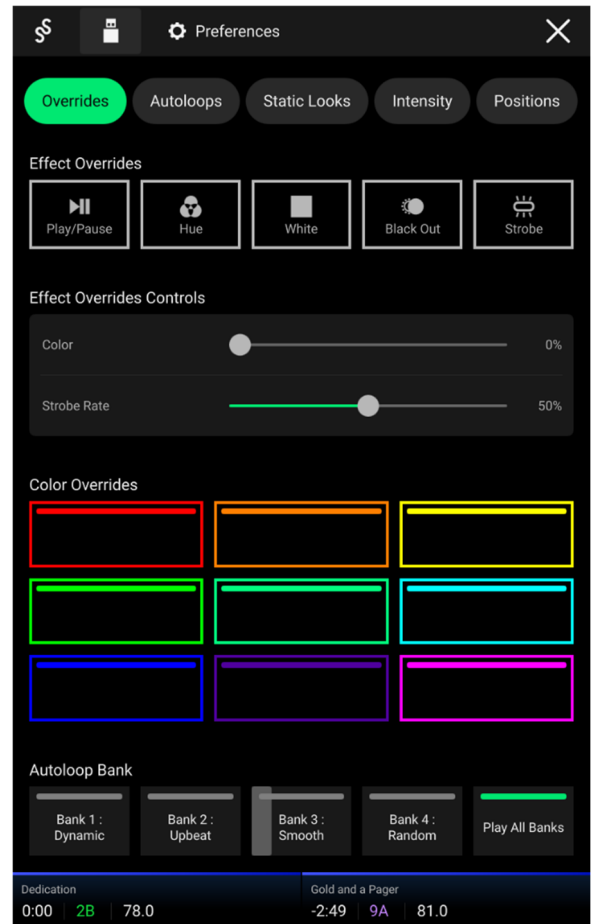

Preferences

Tap the **Preferences** tab at the top of the touchscreen to open the Engine Lighting preferences.

General

- **Engine Lighting Status:** This setting displays the current connection status to Engine Lighting devices. When **Running** is shown, Engine Lighting is active. Tap **Stop** to deactivate Engine Lighting. Tap **Start** to reactivate.
- **Sync Offset:** Use this slider to apply a time offset for syncing your connected lights, from **-1** to **0** to **+1** seconds.
- **Randomize Autoloops:** This setting determines whether autoloops are randomized or play in order.
- **Override Scripted Tracks:** This setting determines whether a scripted track that is paired with an audio file is used (**Off**) or whether you can override it using the onboard controls (**On**). This setting takes effect after loading the next track.
- **Loop Auto Strobe:** This setting allows you to automatically generate strobe effects when a Loop Roll is engaged, or when Auto Loop is set to smaller than 1 Beat.
- **Broadcast Art-Net:** This setting allows you to enable or disable sending Art-Net protocol to control DMX interfaces over a network connection.
- **Strobes:** This setting determines whether strobe effects are enabled or disabled.
- **Philips Hue:** Enable this option to connect to available Philips Hue smart devices.
- **Nanoleaf:** Enable this option to connect to available Nanoleaf devices.
- **Fader Mode:** This setting determines whether the lighting intensity, while lighting is being output from two tracks, takes into account the **Crossfader** position (**Blend**) or the **Channel Faders** only (**Upfader Only**).
- **Repeat Autoloops Mode:** This setting determines whether autoloops are continuously repeated (**Infinite**) or repeated for the **Track Duration** only.
- **Version:** Displays the current Engine Lighting version.

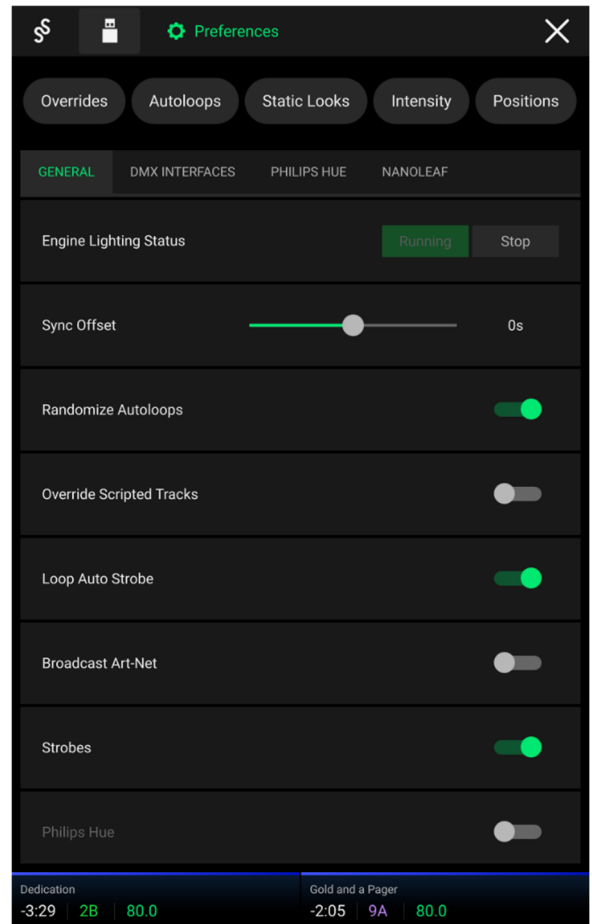

DMX Interfaces

Use this screen to view connected DMX interfaces and their Universe Assignments.

Philips Hue

Use this screen to set up Philips Hue devices.

Nanoleaf

Use this screen to set up Nanoleaf devices.

Appendix

FX Parameters

BPM FX

Echo	Parameter	Value Range
This effect adds echoes of the original signal.	Beats	1/32, 1/16, 1/8, 1/4, 1/3, 1/2, 3/4, 1, 3/2, 2, 3, 4
	Feedback	0–100%
	Frequency	<60 Hz – <18.2 kHz, All Bands, >60 Hz – >18.2 kHz
	Wet/Dry	0–100%

Echo Out	Parameter	Value Range
This effect adds echoes of the original signal with increased feedback at higher wet/dry values for transition effects.	Beats	1/4, 1/3, 1/2, 3/4, 1, 3/2, 2, 3, 4
	Frequency	<60 Hz – <18.2 kHz, All Bands, >60 Hz – >18.2 kHz
	Amount / Feedback	0–100% <50%: Effect is mixed with program audio from the assigned deck. As the value is reduced, the effect wet mix is reduced. 50%: The effect is 100% wet, and no program audio from the deck is heard while the effect is engaged. >50%: The effect is 100% wet, and no program audio from the deck is heard while the effect is engaged. As the value is increased, the tail length (feedback) is increased.

Swell Verb	Parameter	Value Range
This effect adds reverberation to the original signal that grows larger as the amount is increased.	Room Size	0–100%
	Frequency	<60 Hz – <18.2 kHz, All Bands, >60 Hz – >18.2 kHz
	Wet/Dry	0–100%

Delay	Parameter	Value Range
This effect adds repeated instances of the original signal that decay over time.	Beats	1/32, 1/16, 1/8, 1/4, 1/2, 3/4, 1, 2, 3, 4
	Frequency	<60 Hz – <18.2 kHz, All Bands, >60 Hz – >18.2 kHz
	Amount	0–100

Flanger	Parameter	Value Range
This effect adds a slightly delayed copy of the original signal to create a comb-filter effect (often referred to as resembling a jet plane engine).	Beats	1/16, 1/8, 1/4, 1/2, 3/4, 1, 2, 4, 8, 16, 32
	Feedback	0–100%
	Frequency	<60 Hz – <18.2 kHz, All Bands, >60 Hz – >18.2 kHz
	Depth	0–100%

Phaser	Parameter	Value Range
This effect adds a copy of the original signal with its phase shifted slightly to create a subtle, modulatory effect.	Beats	1/16, 1/8, 1/4, 1/2, 1, 2, 4, 8, 16, 32, 64
	Feedback	0–100%
	Frequency	<60 Hz – <18.2 kHz, All Bands, >60 Hz – >18.2 kHz
	Depth	0–100%

Hold Echo	Parameter	Value Range
This effect grabs a chunk of the original audio and holds it.	Beats	1/32, 1/16, 1/8, 1/4, 1/3, 1/2, 3/4, 1, 3/2, 2, 3, 4
	Frequency	<60 Hz – <18.2 kHz, All Bands, >60 Hz – >18.2 kHz
	Amount / Feedback	0–100 0%: The effect is not heard, and the effect buffer is reset if it was previously engaged. <50%: The effect is mixed with the program audio from the assigned deck. As the value is reduced, the effect wet mix is reduced. 50%: The effect is 100% wet, and no program audio from the deck is heard while the effect is engaged. >50%: The effect is 100% wet, and no program audio from the deck is heard while the effect is engaged. As the value is increased, the wet mix is increased, and feedback is increased until there is no decay at 100%.

Ping Pong	Parameter	Value Range
This is a stereo delay effect where the rate of delay is different between the left and right channels.	Beats	1/8, 1/4, 1/2, 3/4, 1, 2, 4
	Pan	0–100% (50 = center)
	Frequency	<60 Hz – <18.2 kHz, All Bands, >60 Hz – >18.2 kHz
	Amount	0–100%

Recycler	Parameter	Value Range
This effect adds an analog-style delay with added warmth and saturation on every cycle.	Beats	1/32, 1/16, 1/8, 1/4, 1/3, 1/2, 3/4, 1, 3/2, 2, 3, 4
	Resonance	0–100%
	Frequency	<60 Hz – <18.2 kHz, All Bands, >60 Hz – >18.2 kHz
	Amount	0–100%

Roll	Parameter	Value Range
This effect samples the current audio signal and repeats it at a regular rate based on the current time division.	Beats	1/32, 1/16, 1/8, 1/4, 1/2, 1, 2
	Frequency	<60 Hz – <18.2 kHz, All Bands, >60 Hz – >18.2 kHz
	Amount / Length	0–100% <50%: Effect is mixed with program audio from the assigned deck. As the value is reduced, the effect wet mix is reduced. 50%: The effect is 100% wet, and no program audio from the deck is heard while the effect is engaged. >50%: The effect is 100% wet, and no program audio from the deck is heard while the effect is engaged. As the value is increased, the choke is increased.

Stutter Out	Parameter	Value Range
This effect adds an echo out in a selected pattern for transition effects.	Pattern	1, 2, 3, 4, 5, 6, 7, 8, 9, 10T, 11T, 12T, 13T
	Bars	1, 2, 3
	Frequency	<60 Hz – <18.2 kHz, All Bands, >60 Hz – >18.2 kHz
	Amount	0–100% As the value is increased, the length of the repeated sample is reduced.

Riser	Parameter	Value Range
This effect adds a glitchy delay that rises in speed and pitch before echoing out.	Time	1/4, 1/2, 3/4, 1, 2
	Length	1–9
	Frequency	<60 Hz – <18.2 kHz, All Bands, >60 Hz – >18.2 kHz
	Amount/Speed	0–100% <50%: Effect is mixed with program audio from the assigned deck. As the value is reduced, the effect wet mix is reduced. 50%: The effect is 100% wet, and no program audio from the deck is heard while the effect is engaged. >50%: The effect is 100% wet, and no program audio from the deck is heard while the effect is engaged. As the value is increased, the speed of the rise is increased.

Pitch Down	Parameter	Value Range
This effect chromatically transposes the pitch of the captured audio down in time with the beat.	Beats	1/16, 1/8, 1/4, 1/3, 1/2, 3/4, 1, 2
	Length	1–9
	Amount / Length	0–100% <50%: Effect is mixed with program audio from the assigned deck. As the value is reduced, the effect wet mix is reduced. 50%: The effect is 100% wet, and no program audio from the deck is heard while the effect is engaged. >50%: The effect is 100% wet, and no program audio from the deck is heard while the effect is engaged. As the value is increased, the length of the repeated sample is reduced.

Scale Down	Parameter	Value Range
This effect transposes the pitch of the captured audio down in a set scale in time with the beat.	Beats	1/16, 1/8, 1/4, 1/3, 1/2, 3/4, 1, 2
	Scale	Major, Minor, Whole, Pentatonic
	Amount / Length	0–100% <50%: Effect is mixed with program audio from the assigned deck. As the value is reduced, the effect wet mix is reduced. 50%: The effect is 100% wet, and no program audio from the deck is heard while the effect is engaged. >50%: The effect is 100% wet, and no program audio from the deck is heard while the effect is engaged. As the value is increased, the length of the repeated sample is reduced.

Reverb	Parameter	Value Range
This effect adds reverberation to the original signal.	Room Size	0–100%
	Frequency	<60 Hz – <18.2 kHz, All Bands, >60 Hz – >18.2 kHz
	Dry/Wet	0–100%

LFO Verb	Parameter	Value Range
This effect adds reverberation to the original signal with a controllable LFO for modulation.	Resonance	0–100%
	Frequency	<60 Hz – <18.2 kHz, All Bands, >60 Hz – >18.2 kHz
	Amount / Rate	0–100% As the value is increased past 50%, the LFO rate increases.

Reverb Drop	Parameter	Value Range
This effect adds reverberation with a drop to the original signal.	Beats	1/8, 1/4, 1/2, 1, 2, 4, 8, 16, 32
	Pump Rate	0, 1/8, 1/4, 1/3, 1/2, 3/4, 1, 2, 4
	Frequency	<60 Hz – <18.2 kHz, All Bands, >60 Hz – >18.2 kHz
	Blend	0–100%

Reverse Verb	Parameter	Value Range
This effect adds reversed reverberation to the original signal.	Beats	1/4, 1/3, 1/2, 3/4, 1, 2, 4
	Delay Time	0–100 ms
	Frequency	<60 Hz – <18.2 kHz, All Bands, >60 Hz – >18.2 kHz
	Dry/Wet	0–100%

Reverb Rise	Parameter	Value Range
This effect adds rising reverberation to the original signal.	Beats	1/8, 1/4, 1/2, 1, 2, 4, 8, 16, 32
	Pump Rate	0, 1/8, 1/4, 1/3, 1/2, 3/4, 1, 2, 4
	Frequency	<60 Hz – <18.2 kHz, All Bands, >60 Hz – >18.2 kHz
	Blend	0–100%

Flanger (–)	Parameter	Value Range
This effect adds a slightly delayed copy of the original signal to create a comb-filter effect (often referred to as resembling a jet plane engine), but with the phase inverted.	Beats	1/16, 1/8, 1/4, 1/2, 1, 2, 4, 8, 16, 32, 64
	Feedback	0–100%
	Frequency	<60 Hz – <18.2 kHz, All Bands, >60 Hz – >18.2 kHz
	Depth	0–100%

Flex Gate	Parameter	Value Range
This effect applies multiple gate types and syncs to the track's phase.	Beats	1/8, 1/4, 1/2, 1, 2
	Pattern	Straight, Pulse, Pumper, Marching, Fader, Offbeats, Off+Pan, L/R Pan, LL/RR Pan
	Dry/Wet	0–100

BeatBreak	Parameter	Value Range
This effect samples the 4 beats of each bar of the original signal and replays them (within the same bar) according to a preset pattern, creating a “stuttering,” “breakbeat” effect.	Pattern	See below
	Frequency	<60 Hz – <18.2 kHz, All Bands, >60 Hz – >18.2 kHz
	Dry/Wet	0–100
<p>To select a pattern to use, turn the FX Parameter knob to select one of 10 patterns, as shown in the Main FX area at the bottom of Performance view. The 16 blocks (■) and/or lines (—) below it indicate the rhythm of the current pattern similarly to a drum machine’s step sequencer: a block represents a “hit”/“strike” and a line represents a rest.</p> <p>Examples:</p> <p>■ ■ ■ — ■ ■ ■ — ■ ■ ■ — ■ ■ ■ —</p> <p>■ — ■ — ■ — ■ — ■ — ■ — ■ — ■ — ■ — (indicates a hit on every 8th note)</p> <p>■ — — ■ ■ — — ■ ■ — — ■ ■ — — ■ ■ — —</p>		

LFO Filter	Parameter	Value Range
This effect varies the cutoff frequency at a regular rate.	Beats	1/16, 1/8, 1/4, 1/2, 3/4, 1, 2, 4, 8, 16, 32
	Resonance	0–100
	Frequency	<60 Hz – <18.2 kHz, All Bands, >60 Hz – >18.2 kHz
	Amount	0–100%

Backspin	Parameter	Value Range
This effect simulates a turntable reverse spin, without losing your place in the track.	Beats	1/4, 1/2, 1, 2, 4, 8
	Speed	Low, Mid, High

Brake	Parameter	Value Range
This effect simulates a turntable slowdown.	Beats	1/4, 1/2, 1, 2, 4, 8

Crush	Parameter	Value Range
This effect applies bit reduction to the original signal for a lo-fi, down-sampled effect.	Crush	0–100%
	Amount	0–100%
	Frequency	<60 Hz – <18.2 kHz, All Bands, >60 Hz – >18.2 kHz

Touch FX

LFO Echo	Parameter		Value Range
This effect adds echoes of the original signal, with a filter cutoff frequency varied at a regular rate.	X-Axis	Beats	8, 4, 2, 1, 3/4, 1/2, 1/4, 1/8
	Y-Axis	Resonance	0–100
		Feedback	0–100

Filter Roll	Parameter		Value Range
This effect samples the current audio signal and repeats it at a regular rate based on the current time division, with an additional filter.	X-Axis	Beats	2, 1, 1/2, 1/4, 1/8, 1/16, 1/32
	Y-Axis	Filter	Lo–Hi
		Resonance	0–100

Filter Echo	Parameter		Value Range
This effect adds echoes of the original signal with an additional filter.	X-Axis	Beats	1, 3/4, 1/2, 1/4, 1/8, 1/16
	Y-Axis	Filter	Lo–Hi
		Amount	0–100

Filter Dub Echo	Parameter		Value Range
This effect adds spring reverb-like echoes of the original signal with an additional filter for dub style effects.	X-Axis	Beats	1, 1/2, 1/4, 1/8
	Y-Axis	Filter	Lo–Hi
		Resonance	0–100
		Amount	0–100

Filter Gate	Parameter		Value Range
This effect applies filtered level reduction to the original signal at the set rate.	X-Axis	Beats	1, 1/2, 1/4, 1/8, 1/16
	Y-Axis	Filter	Lo–Hi
		Resonance	0–100

Noise Gate	Parameter		Value Range
This effect applies filtered level reduction and noise to the original signal at the set rate.	X-Axis	Beats	1, 1/2, 1/4, 1/8, 1/16
	Y-Axis	Filter	Lo–Hi
		Reverb	0–100
		Noise Volume	-20 – 15 dB

Filter Reverb	Parameter		Value Range
This effect adds filtered reverberation to the original signal.	X-Axis	Amount	0–100
	Y-Axis	Filter	Lo–Hi
		Room Size	0–100

Flanger	Parameter		Value Range
This effect adds a slightly delayed copy of the original signal to create a comb-filter effect (often referred to as resembling a jet plane engine).	X-Axis	Speed	16, 8, 4, 2, 1, 1/2, 1/4, 1/8
	Y-Axis	Resonance	0–100

LFO Filter	Parameter		Value Range
This effect varies the cutoff frequency at a regular rate.	X-Axis	Beats	8, 4, 2, 1, 3/4, 1/2, 1/4, 1/8
	Y-Axis	Resonance	0–100

Filter	Parameter		Value Range
This effect adds a resonant filter to the original signal.	X-Axis	Resonance	0–100
	Y-Axis	Cutoff	Lo–Hi

Technical Specifications

Digital Audio		
Converters	Cirrus Logic, 24-bit PCM, 44.1 kHz	
Digital Signal Processing	32-bit, Floating Point, Double Precision	
Audio Outputs		
Main Output (XLR, RCA stereo pair)	DAC	24-bit
	Dynamic Range (DR)	117 dB
	Output Type	Balanced XLR
	Maximum Output Level (XLR)	8 Vrms
	Maximum Output Level (RCA)	4 Vrms
	Frequency Response	20 Hz – 20 kHz: +0, -1 dB
	THD+N	0.002% @ 1 kHz, 4 Vrms
	Channel Separation	> 80 dB
	Input Gain Trim Range	Off to +12 dB
	Output Level Range	Off to 0 dB
Booth Output (1/4" [6.35 mm] TRS)	DAC	24-bit
	Dynamic Range (DR)	117 dB
	Output Type	Balanced TRS
	Maximum Output Level	8 Vrms
	Frequency Response	20 Hz – 20 kHz: +0, -1 dB
	THD+N	0.002% @ 1 kHz, 4 Vrms
	Channel Separation	> 80 dB
	Input Gain Trim Range	Off to +12 dB
	Output Level Range	Off to 0 dB
	Headphone Output (1/4" [6.35 mm] and 1/8" [3.5 mm] TRS)	DAC
Dynamic Range (DR)		117 dB
Output Type		Stereo TRS (1/8" and 1/4" jacks)
Cue Features		Cue / Split Cue
Maximum Output Level (No Load)		4 Vrms
Max Power Output into 50 Ω		150 mW
Frequency Response		20 Hz – 20 kHz: +0, -1 dB
THD+N @ 1 kHz, 4 Vrms (No Load)		0.002%
THD+N @ 1 kHz, Full Power @ 50 Ω		0.08%
Channel Separation		> 80 dB
Level Control Range		Off to 0 dB

Inputs		
Microphones 1 & 2 (Combo XLR/1/4" [6.35 mm] TRS)	ADC	24-bit, 115 dB DR
	Input Type	Balanced XLR/TRS combo
	Maximum Input Level	110 mV
	Analog Gain	25 dB
	Maximum System Gain	60 dB
	Frequency Response @ 20 Hz	-2.5 dB
	Frequency Response @ 20 kHz	-5 dB
	THD+N @ 0.1 Vin, Gain = 25 dB	0.015% (100 Hz–20 kHz)
	DR (A-weighted), Gain = 25 dB	102 dB
	DR (A-weighted), Gain = 60 dB	72 dB
	IRN (A-weighted), Gain = 60 dB	-132 dB
	IRN (20 Hz–20 kHz), Gain = 60 dB	-130 dB
Auxiliary Input (RCA stereo pair)	ADC	24-bit, 115 dB DR (A-weighted)
	Input Type	Unbalanced RCA
	Maximum Input Level	4 Vrms
	Frequency Response	20 Hz – 20 kHz: +0, -1 dB
	THD+N @ 3 Vrms, Unity Gain	0.005% (20 Hz–20 kHz)
	Gain Range	Off to +12 dB
	DR (A-weighted), Unity Gain	108 dB
	Crosstalk	≤ -90 dB
Performance Pads		
Pads	(16) on/off multi-color back-lit pads (8 per deck)	
Faders		
Channel Faders	(2) PRECISION FEEL tension-adjustable faders with contour and reverse	
Crossfader	(1) MAG FOUR tension-adjustable crossfader with contour and reverse	
Displays		
Main Display	Full color LED-backlit display with touch interface 7" / 178 mm (diagonal)	
Pad Displays	(8) 128 x 32 Monochrome OLEDs	
CPU		
Processor	8-core ARM® processor	
RAM	4 GB	
Wi-Fi & Bluetooth		
Wi-Fi	2.4 GHz / 5 GHz 802.11a/b/g/n/ac Wi-Fi 5	
Wireless Technology	Bluetooth® - Qualified against Bluetooth® Core 5.4	

Supported Media		
File Systems	exFAT (recommended) FAT32	
Playable Media	AAC/M4A AIF/AIFF (44.1–192 kHz, 16–32-bit) ALAC FLAC MP3 (32–320 kbps) MP4 Ogg Vorbis WAV (44.1–192 kHz, 16–32-bit)	
Streaming Services		
Onboard Streaming Services (Subscription required)	Amazon Music Unlimited Apple Music Beatport Beatsource SoundCloud Go+ TIDAL (+ DJ add-on)	
Lighting		
Onboard Smart Lighting	Philips Hue Nanoleaf	
Supported DMX	SoundSwitch DMX Micro SoundSwitch Control One	
Power		
Power Supply	Input Type	IEC
	Input Voltage	100–240 VAC
	Frequency	50/60 Hz
	Power Consumption	150 W
General		
Dimensions (width x depth x height)	29.00" x 15.87" x 5.70" 73.66 x 40.30 x 14.47 cm	
Weight	29.4 lbs. 13.33 kg	

Connections		
Inputs	Microphones	Mic 1: XLR + 1/4"/6.35 mm Combo Jack Mic 2: XLR + 1/4"/6.35 mm Combo Jack
	Aux	Stereo Pair (RCA)
Outputs	Main	(2) XLR Stereo Pair (RCA)
	Booth	(2) 1/4"/6.35 mm TRS Jacks
	Headphones	1/4"/6.35 mm Stereo Jack 1/8"/3.5mm Stereo Mini-Jack
Media Inputs	USB	USB 1: Type-A, USB 2.0 High Speed USB 2: Type-C, USB 3.0 SuperSpeed USB 3: Type-A, USB 3.0 SuperSpeed USB 4: Type-A, USB 3.0 SuperSpeed To Computer: Type-C, USB 3.0 SuperSpeed
	SD Media Input	SD, SDHC, SDXC
	Internal HD	SATA 3.0
Power		IEC

Specifications are subject to change without notice.

Trademarks & Licenses

Rane is a trademark of inMusic Brands, Inc., registered in the U.S. and other countries.

Amazon and all related marks are trademarks of Amazon.com, Inc. or its affiliates.

The *Bluetooth* word mark and logos are owned by the Bluetooth SIG, Inc., and any use of such marks by Rane is under license.

macOS and Apple Music are trademarks of Apple Inc., registered in the U.S. and other countries.

Serato, Serato DJ Pro, and the Serato logo are registered trademarks of Serato Audio Research.

SD, SDHC and SDXC are registered trademarks of SD-3C, LLC.

Windows is a registered trademark of Microsoft Corporation in the United States and other countries.

All other product names, company names, trademarks, or trade names are those of their respective owners.

The following technologies are used in Engine OS products:

ELASTIQUE efficient V3 by zplane.development

TONART V3 by zplane.development

This product uses other software and technology under license. Please visit enginedj.com/product-legal for a complete list.

rane.com

enginedj.com