

ME PERSONAL MIXING SYSTEM

UNIVERSAL 40 CHANNEL MONITORING SYSTEM



ME 1 Personal Mixer

User Guide

Publication AP8997

Limited One Year Manufacturer's Warranty

This product is warranted to be free from defects in materials or workmanship for period of one year from the date of purchase by the original owner.

To ensure a high level of performance and reliability for which this product has been designed and manufactured, read this User Guide before operating.

In the event of a failure, notify and return the defective unit to the place of purchase. If this is not possible then please contact the authorised ALLEN & HEATH distributor or agent in your country as soon as possible for repair under warranty subject to the following conditions:

Conditions Of Warranty

The product has been installed and operated in accordance with the instructions in this User Guide.

The product has not been subject to misuse either intended or accidental, neglect, or alteration other than as described in the User Guide or Service Manual, or approved by ALLEN & HEATH.

Any necessary adjustment, alteration or repair has been carried out by an authorised ALLEN & HEATH distributor or agent.

The defective unit is to be returned carriage prepaid to the place of purchase, an authorised ALLEN & HEATH distributor or agent with proof of purchase. Please discuss this with the distributor or the agent before shipping.

If the unit is to be repaired in a different country to that of its purchase the repair may take longer than normal, whilst the warranty is confirmed and parts are sourced.

Units returned should be packed to avoid transit damage.

Check with your ALLEN & HEATH distributor or agent for any additional warranty which may apply.

If further assistance is required please contact Allen & Heath Ltd.



The ME range of products complies with the European Electromagnetic Compatibility directive 2004/108/EC and the European Low Voltage Directive 2006/95/EC.

Any changes or modifications to the product not approved by Allen & Heath could void the compliance of the product and therefore the users authority to operate it.

ME-1 Personal Mixer User Guide AP8997 Issue 3
Copyright © 2014 Allen & Heath. All rights reserved

ALLEN&HEATH

<http://www.allen-heath.com>

READ THESE INSTRUCTIONS FIRST:



Safety instructions

Before starting, read the **IMPORTANT SAFETY INSTRUCTIONS** sheet supplied with the product and downloadable from the Allen & Heath web site. For your own safety and that of the operator, crew and performers, follow all instructions and heed all warnings printed in the sheet, this guide and on the product.



Sound levels

This product is capable of producing high sound levels which may be harmful to your hearing. To avoid the risk of damage to your hearing when working with headphones, ear pieces or loudspeakers do not operate at high volumes for an extended period of time. The ME-1 mixer provides a limiter function which can be set to prevent the level exceeding a comfortable maximum.



Mounting

The mixer is designed to be used on a flat surface or mounted to a microphone stand using the built-in thread adapter or the mounting bracket supplied with the unit. When using a mic stand locate it so that it is stable and will not topple over and cause damage or injury. Ensure cables are routed to avoid a trip hazard.



General precautions

- To prevent damage to the mixer, avoid dropping it, placing objects on the control surface, scratching the surface or screen with sharp objects, or rough handling and vibration in operation or transit.
- Protect the mixer from damage through liquid or dust contamination. Cover the mixer when it is not being used for a long period.
- Computer and screen technology can be affected by extreme heat or cold. If the mixer has been stored in extreme cold allow time for it to reach normal operating temperature before use. Avoid using the mixer in direct sunlight. Recommended operating temperature is 5 to 35 degrees Celsius.
- Clean the control surface with a soft brush and dry lint-free cloth. Do not use chemicals, abrasives or solvents.
- It is recommended that servicing is carried out only by an authorised Allen & Heath agent. Save your data before sending the mixer for servicing. Allen & Heath do not accept liability for damage or data loss caused by maintenance, repair or modification by unauthorised personnel.

Operating firmware

The function of the ME-1 mixer is determined by the operating firmware that runs within it. Firmware is updated when new features are added or improvements made. Check the Allen & Heath web site for the latest version available. This can be downloaded, transferred to USB key and then loaded into the ME-1 mixer using the Firmware Setup menu.

www.allen-heath.com/me-1

Software licence agreement

By using this Allen & Heath product and the software within it (the firmware) you agree to be bound by the terms of the relevant End User Licence Agreement (EULA), a copy of which can be found on the Allen & Heath web site. You agree to be bound by the terms of the EULA by installing, copying, or using the software.

www.allen-heath.com/legal

Further information

Please refer to the Allen & Heath website for further information, knowledgebase and technical support. You can join our Allen & Heath Digital Community to share knowledge and information with other ME-1 users.

Register Your Product

Register your ME-1 with Allen & Heath online at:

<http://www.allen-heath.com/register>

Packed Contents

The following items are included in the box when the ME-1 mixer is shipped:

ME-1 Personal Mixer

The mixer.



DC Power Supply for the ME-1 mixer

A universal voltage mains power supply unit is provided. This comes with a choice of 4 different worldwide plug adapters. The adapter clips into the power unit.



Microphone stand side mounting bracket

The mixer has a built-in 3/8" thread to mount it to the top of a microphone stand. A bracket is also provided for mounting to the side of a microphone stand.



Headphone holder

A hook that presses into the underside of the mixer to hang headphones or ear pieces while mounted to a microphone stand.



Safety Instruction Sheets

AP3345 – English

AP7287 – French

AP8513 – Chinese

AP8889 - Spanish

- Read this sheet before starting

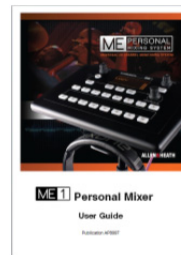
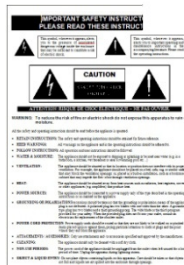

User Guide

This user guide.

Note Cat5 Link cables are not provided. Source cables of suitable length to meet your application requirements. More information is provided later in this guide.

The following cables are available from Allen & Heath:



AH8822 2m (6.6') short patch

AH9651 20m (66') coil

AH9650 100m (330') drum

1. Contents

1. Contents	6	8. Setting up ME-1	23
2. Introduction	8	8.1 Patching mixer outputs to ME-1.....	23
3. A first look.....	11	8.2 Setup mode.....	24
4. Front Panel.....	12	8.3 Adjusting the brightness	24
5. Rear Panel.....	13	8.4 The About screen.....	24
6. Installing ME-1.....	14	8.5 Assigning Key Sources.....	24
6.1 Mounting the unit.....	14	8.6 Auto Names and Stereo linking	25
6.2 Cat5 cable	14	8.7 Setting up Groups.....	27
6.3 Ethernet Switch	14	8.8 Key assignment Auto Mode.....	27
6.4 Connecting audio	15	8.9 Assigning key Names	28
7. Operating ME-1	16	8.10 Assigning key preset mode	28
7.1 Turning the mixer on or off.....	16	8.11 Working with Configurations.....	29
7.2 Standby	16	8.12 Changing the Unit Name	30
7.3 Operating modes	16	8.13 Local Mic Mute Option.....	30
7.4 Rotary control.....	16	8.14 Updating the ME-1 firmware	30
7.5 Screensaver.....	17	9. Reference.....	31
7.6 The Home screen	17	9.1 Working with USB keys.....	31
7.7 Stereo Meter	17	9.2 To Reset the ME-1.....	31
7.8 Adjusting Master Level	17	9.3 To Reset auto Names and Links....	31
7.9 Adjusting Local Mic level.....	17	9.4 Specification.....	32
7.10 Selecting sources.....	18		
7.11 Adjusting Level and Pan.....	18		
7.12 Trimming All levels	18		
7.13 Muting a source or master	19		
7.14 Using Solo to listen to sources	19		
7.15 Adjusting Group master level.....	19		
7.16 Adjusting Group source levels	19		
7.17 Adjusting the Master EQ	20		
7.18 Adjusting the mix Limiter	20		
7.19 Presets.....	20		
7.20 Recalling a Preset from a key.....	20		
7.21 Recalling a Preset from USB.....	21		
7.22 Storing a Preset to a key	21		
7.23 Storing a Preset to USB	21		
7.24 Editing a Preset	21		

ME-1 is part of the Allen & Heath **ME** personal mixing system. ME-1 can work with Allen & Heath GLD, iLive and Qu mixers, or with third party systems via the ME-U hub.

Any number of ME-1 mixers can be positioned on stage or anywhere personal control is needed. ME-1 receives multiple channels of audio via a Cat5 cable link from the main console and mixes it to its own outputs typically feeding headphones, in-ears or local speakers. It lets each musician, artist or presenter manage their own monitor mix thus freeing up the house engineer to concentrate on the FOH mix.

This example shows ME-1 working with the GLD mix system:

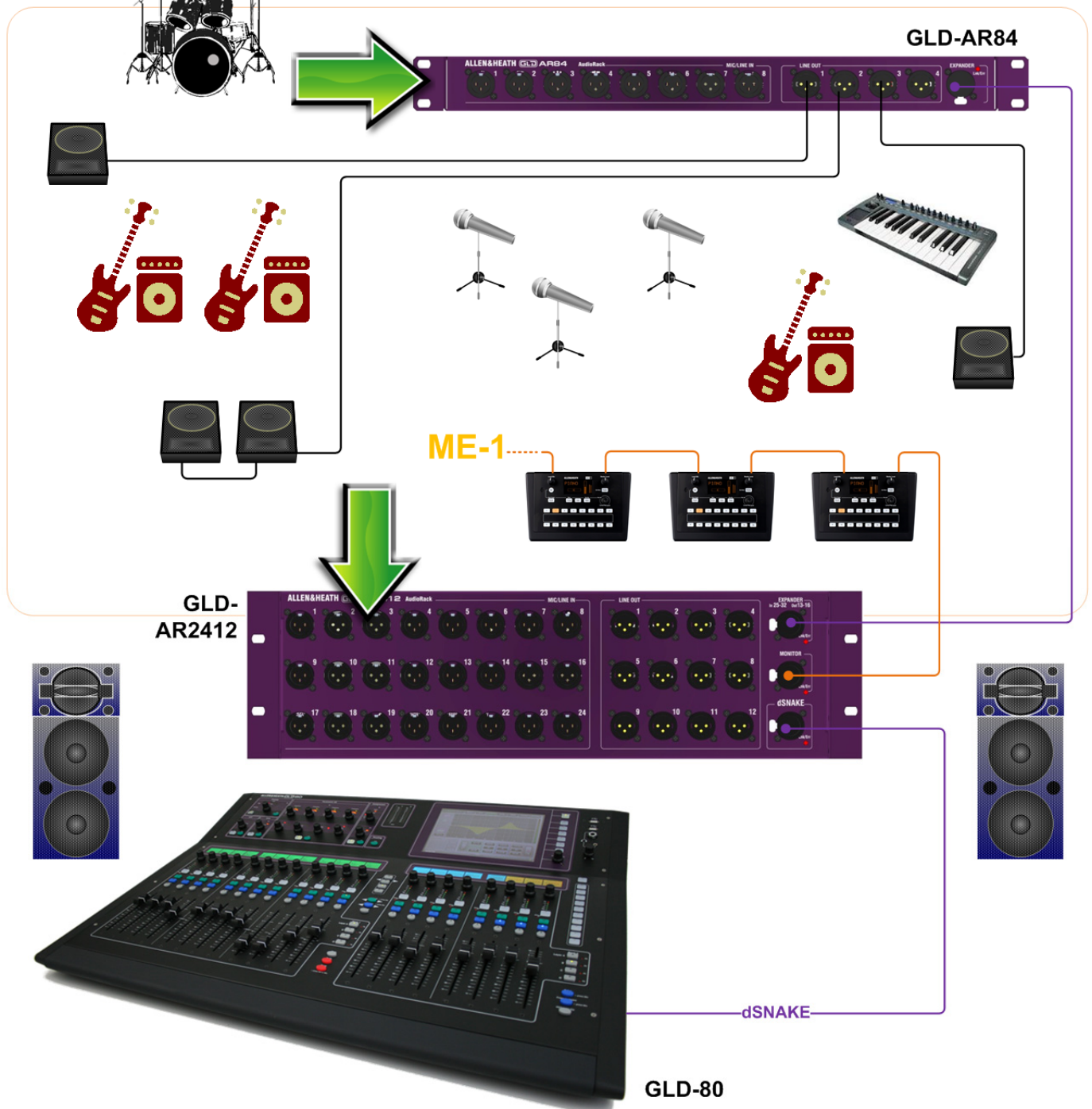

2. Introduction



Welcome to the ME Personal Mixing System, a uniquely flexible yet intuitively easy to operate solution giving individual musicians, performers and presenters the freedom to control their own monitor sound whether on stage, in houses of worship, in rehearsal rooms, studios, conferences or live events.

The ME-1 is a stand-alone digital personal mixer receiving up to 40 sources via a single Cat5 cable from the main console and mixing these to a stereo and mono output to drive headphones, in-ears, drum throne, loudspeakers or other monitoring devices.

Take the pressure off the sound engineer by letting the musicians manage their own monitor mixes. Eliminate the need to use up main console buses by grouping the 40 channels within the ME-1 to simplify control for each musician. Assign as few or as many of the 16 keys as they need or can manage.

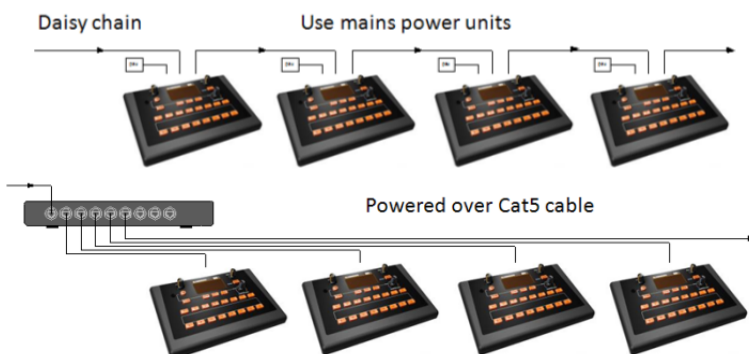

Designed for the application

- Compact and smart on stage
- Easy to read OLED screen
- Backlit keys for viewing in the dark
- Surface, plinth or mic stand mounting
- Built-in top of stand mount
- Side of stand bracket provided
- Headphones hook provided

Easy for the musician to operate

- Press a Select key.
- Turn rotary to adjust Level
- Press and turn to adjust Pan
- Hold shift and turn to trim all levels
- Mute individual selections or master
- Solo individual selections
- Balance group sources using Group mode
- Add a local source such as MP3 player
- Dial up stage sound using the local mic
- Adjust local mic independently of mix level
- Adjust tone using the 3-band master EQ
- Prevent loud peaks using the Limiter
- Store and recall presets of your mix.
- Protect while away using Standby mode

Customise to suit each musician

- Configure how much control to provide
- Assign keys or leave them unused
- Choose source for each of the 16 keys:
- None, any of 40 channels, Aux In, Groups
- Set Groups for simple multi source control
- Assign presets for store/recall or recall only
- Use default or set custom key names
- Set a Unit name to identify the mixer
- Name and archive the configuration
- Use the config name to identify user
- Transfer config or presets via USB key
- Update firmware via USB key

Convenient connection

- Daisy chain any number of ME-1 mixers
- Parallel connect using Ethernet switch
- Single Cat5 cable carries audio and names
- Direct connection to GLD or Qu dSNAKE
- Direct connection to iLive ACE
- Direct connection to Aviom® A-Net 16
- Connect to other networks via ME-U hub:
- 48kHz Dante, MADI, EtherSound
- Use PSU supplied or PoE via Cat5 cable
- Touring grade 10-port ME-U PoE hub

GLD Daisy chain

Channels	40	
Stereo links	✓	from GLD
Auto names	✓	from GLD

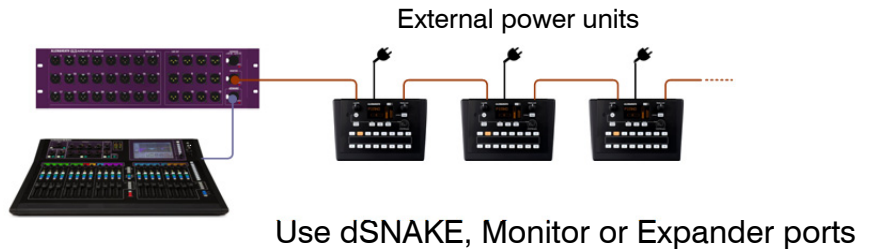

GLD Parallel connection

Channels	40	
Stereo links	✓	from GLD
Auto names	✓	from GLD
Standard switch	✓	
PoE switch	✓	

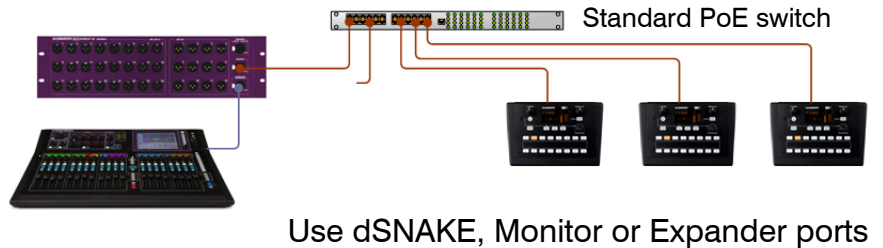

iLive From Port B ACE

Channels	40	
Stereo links	✗	use groups
Auto names	✗	use local names
Standard switch	✓	
PoE switch	✓	Standard or ME-U

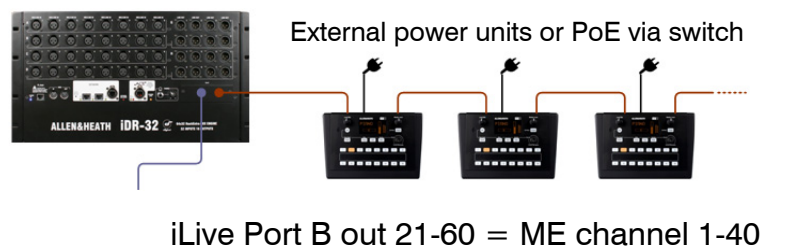

iLive MMO (or any Aviom® A-Net 16 source)

Channels	16	
Stereo links	✓	
Auto names	✗	use local names
Standard switch	✗	use Aviom® hub
PoE from hub	✗	

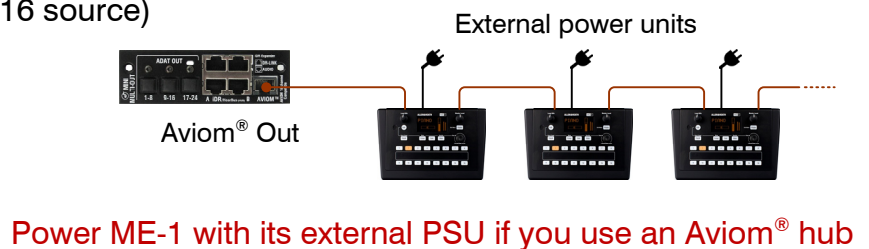

iLive Port B ACE via ME-U

Two cables - Audio and Network

Channels	40	
Stereo links	✓	from iLive or ME-U
Auto names	✓	from iLive or ME-U
PoE from hub	✓	from ME-U

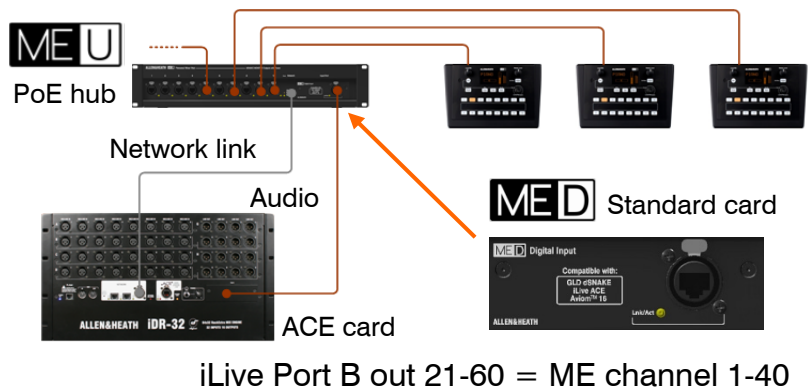

iLive Port B Dante via ME-U

Two cables - Audio and Network

Channels	40	
Stereo links	✓	from iLive or ME-U
Auto names	✓	from iLive or ME-U
PoE from hub	✓	from ME-U

Similar applies to using MADI or EtherSound option cards with iLive.

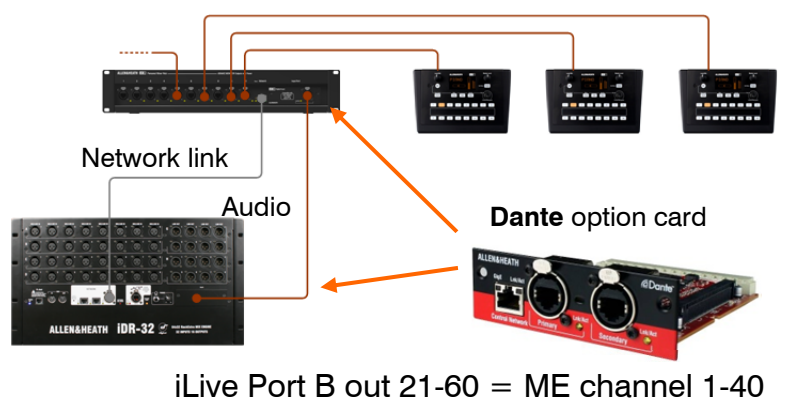

QU Daisy chain

Channels 40
 Stereo links ✓ from Qu
 Auto names ✓ from Qu

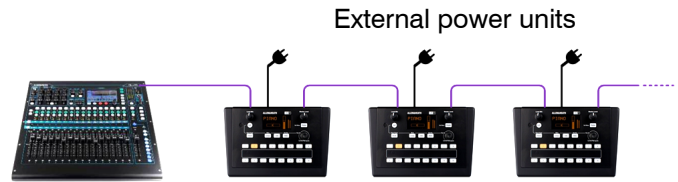

From rear panel dSNAKE port

QU Parallel connection

Channels 40
 Stereo links ✓ from Qu
 Auto names ✓ from Qu
 Standard switch ✓
 PoE switch ✓ Standard or ME-U

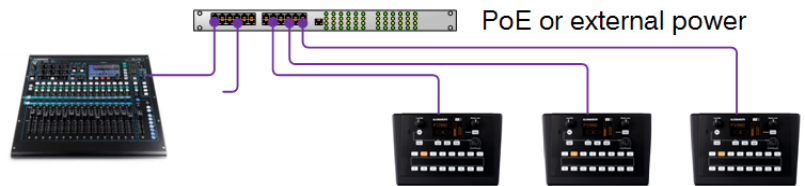

From rear panel dSNAKE port

QU From AB168 AudioRack

Channels 40
 Stereo links ✓ from Qu
 Auto names ✓ from Qu

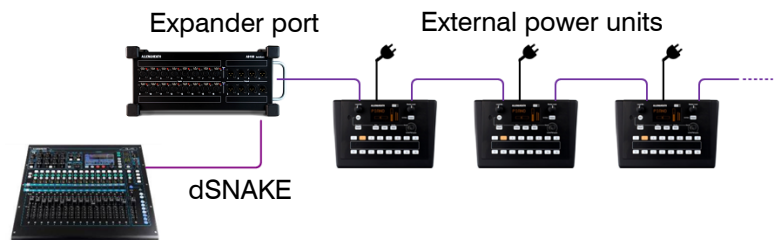

Use AB168 Expander port

QU From AR2412 AudioRack

Channels 40
 Stereo links ✓ from Qu
 Auto names ✓ from Qu

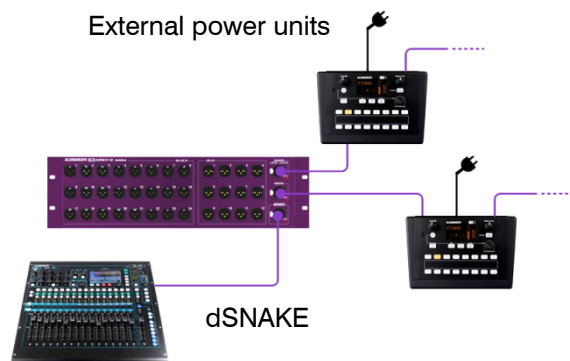

Use AB2412 Monitor and/or Expander port

Other

Using ME-U with option card
 Dante, MADI, EtherSound 48kHz

Channels up to 40
 Stereo links ✓ from ME-U
 Auto names ✓ from ME-U
 PoE from hub ✓ from ME-U

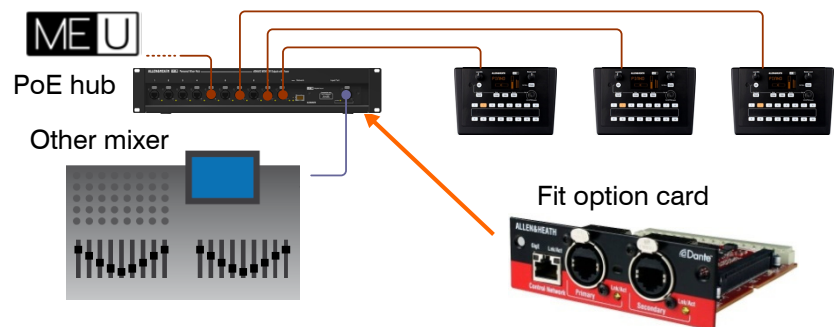

Dante, MADI, EtherSound (48kHz)

3. A first look...

We recommend you read through this user guide first. However, if you are keen to get started right away then follow these brief instructions:

Check the contents – Check against the Packed Contents list and read the Safety Instructions sheet.

Power up the ME-1 mixer – Fit the correct power unit plug adaptor for your local mains supply. Plug in and apply power.

Finding your way around ME-1 – You can test your ME-1 without the need to connect it to a mixing system.

The **Home** screen displays the current configuration name after power up. The ME-1 ships with the factory Config 'ME' loaded.

To recall a **DEMO preset** hold down the Recall key + press Key1. Press Key1 again to confirm. Release the keys. This recalls an example setup for a lead singer in a band.

Get a feel for how the ME-1 operates:

- View the names on the screen,
- Turn the rotary to adjust Level,
- Press and turn to adjust Pan,
- Press Key 1 and the Group key,
- Press Master to find the EQ and Limiter.

Listen to some audio – Turn off both level controls. Plug in your headphones and an MP3 player into the rear Aux Input socket.

Slowly turn up the **Local Mic** and listen to the ambient sound in the room.

Press Key 9, start your **MP3 player** and slowly turn up the Master Level. You should hear the music in your headphones and see the meter moving.

Press Key 10 to add in some test tone.

Experiment with the controls.:

- Listen to the audio,
- Toggle Mute,
- Press + hold Solo to listen to one source.

Now read the rest of this guide ☺

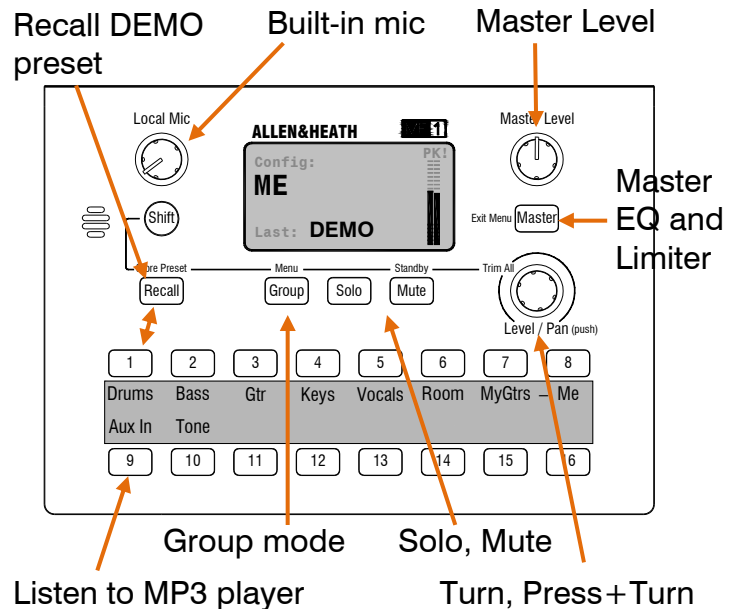

The factory **ME** config

A 'Config' stores all ME-1 settings and presets and can be transferred via USB key. The 'ME' config is pre-loaded when the ME-1 ships and can also be downloaded from the Allen & Heath web site to give you a starting point for configuring your own setup:

- All keys set to Auto Mode (assign the first available channels they find with any linked as stereo assigned to single keys),
- Names set to default (channel numbers or names received via the Cat5 cable),
- Preset store/recall enabled for all keys

Four presets are configured:

Preset 1 DEMO – Example for a lead singer in a band:

- Key 1-5 = The rest of the band
- Key 6 = The room (audience)
- Key 7-8 = My vocal and instruments
- Key 9 = Local Aux Input (MP3 player)
- Key 10 = 1kHz sine wave (test tone)
- Key 11-16 = not assigned

Preset 2 AUTO – All keys set Auto Mode, a useful starting point.

Preset 3 1TO16 – Keys assigned to channels 1-16, a quick way to start when working in Aviom® 16 channel mode.

Preset 4 CLEAR – All keys unassigned, for setting up from a blank starting point.

4. Front Panel

Local Mic – Built-in microphone to add stage sound and hear fellow musicians who come up and talk to you. Separate Level control. Not affected by Master Level control. Option to disable the mic.

Screen – Illuminated screen for big display of selection name, level and pan and stereo signal meter. Also used for master EQ and Limiter, config and preset information and the Setup menu.

Master Level – Adjust the overall mix level. Does not affect local mic level.

Master Key – Access the master EQ and Limiter. Also used to exit a menu during setup.



Shift key – Hold and press:
 +Recall = Enter Store mode
 +Group = Enter Setup menu
 +Mute = Enter/exit Standby
 +Rotary = Trim all levels

Preset Recall key – Hold and press a Select key to recall a preset, or recall a preset direct from USB key.

Preset Store mode – Store current key assignments, names and group members as a preset to a key or direct to USB.

Group key – Lights if the selection is a group. Press to enter Group mode and adjust the Level/Pan of members within the group. Also used to exit the Setup Menu.

Solo key – Press to enter Solo mode and listen to just the current selection. The meter displays the level of the selected source. Press and hold for momentary solo.

Mute key – Press to mute the selection. Lights red when muted.

Select keys – Press one of 16 keys to adjust its assigned source. A fast flash shows its selection is muted. Also used for store and recall of up to 16 presets.

Rotary – Turn to adjust Level, press and turn to adjust Pan for the selection.

Press Shift and turn to trim all selection levels, or to trim all group members while in Group mode.

Also used for scrolling and entering setup menu options.

5. Rear Panel

Phones – 3.5mm mini-jack and ¼” TRS stereo jack to connect to one or two headphones or earpieces, or to line level equipment such as wireless in-ear transmitter or powered speakers. Includes the mix and local mic signal.

Tip = Left, Ring = Right.

Mono Out – Balanced TRS jack to connect to mono line level equipment such as a powered speaker or drum throne.

The output is the mono sum of the Left and Right mix. Does not include the local mic signal.

Aux In – 3.5mm mini-jack to plug in a local stereo line source such as an MP3 player or click track.

Aux In can be assigned to one of the Select keys. Its signal will be turned off if it is not assigned to any key.

Tip = Left, Ring = Right.



Mounting methods:

Surface – Non-slip rubber feet for using on a flat surface.

Top or mic stand – Built-in underside standard 3/8” threaded insert.

Side of mic stand – A suitable bracket is provided with the ME-1. Fixes using the 3/8” underside insert.

Plinth – Can be fixed into a surface using screws that fix into the plastic surround.



Headphones hook

Link In– Locking EtherCon connector to plug in a Cat5 cable from the source.

Receives 40 channels of audio when connected to GLD or Qu dSNAKE, iLive ACE or to the ME-U hub, or 16 channels of audio when connected to Aviom® A-Net 16.

Can also receive names and stereo link information.

The mixer can be powered via the Link In Cat5 cable instead of the DC In socket when connected to a PoE switch or the ME-U hub.

Link Out – Locking EtherCon connector to plug in a Cat5 cable to feed audio to the next ME-1 when daisy chaining mixers.

Link Out does not carry PoE power. Daisy chained mixers are powered using their external power units.

DC In – External PSU (power supply) input. The mixer can be powered by plugging the DC cable of the mains power unit provided with the ME-1 into this socket.

Alternatively, the mixer can be powered via the Link In Cat5 cable when connected to a PoE (Power over Ethernet) switch or the ME-U hub.

USB port – For data transfer between ME-1 mixers or to back them up to computer.

Transfer individual presets or the full configuration. Also used for updating the ME-1 operating firmware.

Set up many ME-1 mixers quickly by configuring one and then copying its settings to the others as a starting point.

6. Installing ME-1

6.1 Mounting the unit

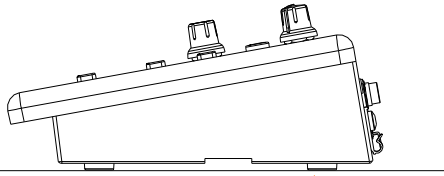

Surface mount – Non-slip feet

Note Do not place near hot equipment.

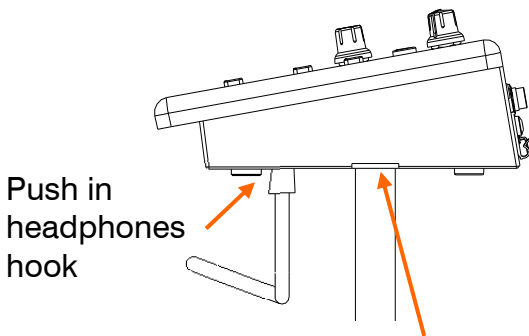

Push in headphones hook

Top of stand mount – 3/8" thread

Note Ensure the mic stand is stable.

Microphone stand

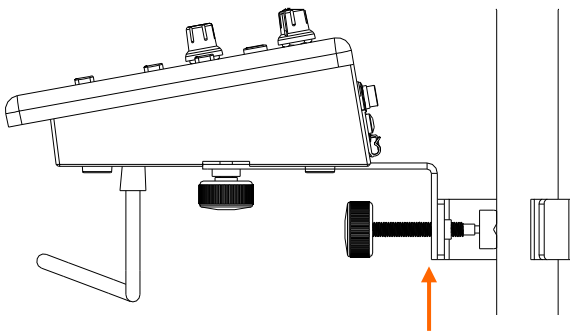

Side of stand mount – Bracket supplied

Plinth mount – Holes for 6B screws

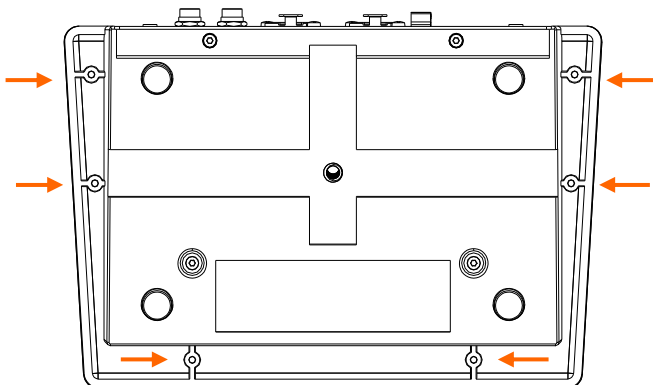

6.2 Cat5 cable

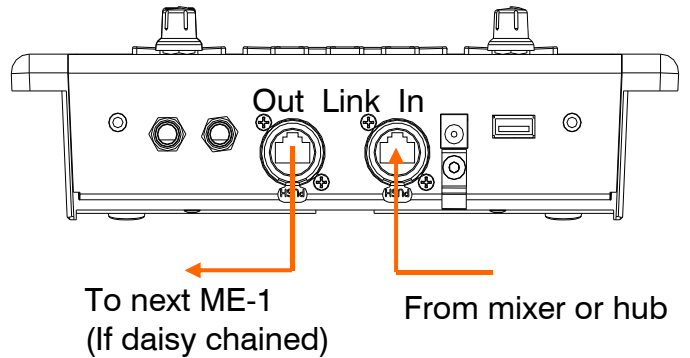

Use STP (shielded twisted pair) CAT5e or higher cables. Those with both foil and braided screens provide shielding from interference and are generally more rugged. Stranded core cables are less prone to damage when kinked or repeatedly coiled.

ME-1 provides locking Neutrik EtherCon sockets to protect the connections and ensure suitability for touring. Use cables fitted with locking EtherCon plugs.

Maximum length per cable = 100m (330')



6.3 Ethernet Switch

For parallel connection of multiple ME-1 mixers each with their own cable you can use a standard off-the-shelf Ethernet switch.

Note Aviom® A-Net 16 is not compatible with standard Ethernet switches.

An unmanaged 100 Mbit/s (Fast Ethernet) or Gigabit switch is suitable.

Note The use of a 3-layer PoE switch is not recommended.

For PoE (Power over Ethernet) either of the two standards 802.3af (15.4W at source) or 802.at (25.5W at source) is suitable. Check that the overall power rating is enough to provide for all ME-1 mixers you wish to connect (allow 15W per mixer).

The Allen & Heath ME-U hub provides PoE and connections for up to 10 ME-1 mixers.



6.4 Connecting audio

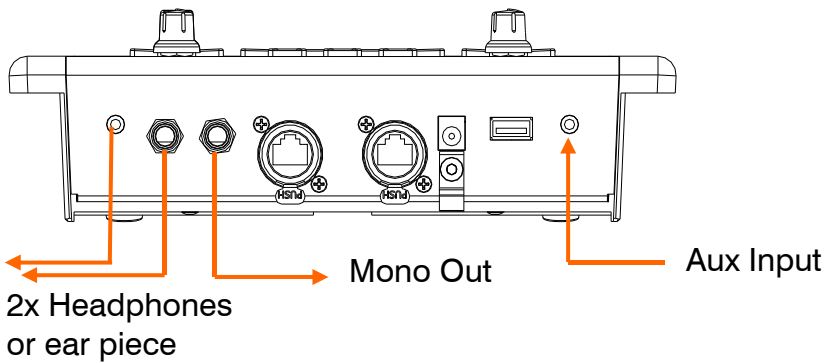

Stereo Headphones – Two output sockets allow plugging in headphones or ear pieces with either a large (1/4”) or small (3.5mm) stereo plug. Headphones with impedance between 16Ω and 600Ω are recommended. Lower impedance headphones tend to be louder.

You can choose which socket to use or use both at the same time, for example to feed two musicians with the same mix.

Stereo line equipment – You can use the stereo outputs to feed line level equipment such as a recording device or wireless in-ear transmitter.

Maximum line output level = +21dBu.

The ME-1 presents both the left and right signals on the same TRS (3-pole stereo) output jack. The same stereo signal is duplicated on the large and small output sockets.

Use a stereo Y-cable to feed equipment with separate left and right inputs.

The output is unbalanced. To connect to balanced equipment link the input cold (-) signal to ground within the destination plug.

Mono output – The output can feed balanced or unbalanced line level equipment such as a powered speaker.

Aux Input – A 3.5mm mini-jack input socket is provided to plug in a stereo source such as MP3 player. To use a mono source, for example a click track, link the tip (left) and ring (right) connections within the plug.

Connecting the ME-1 to stereo line equipment:

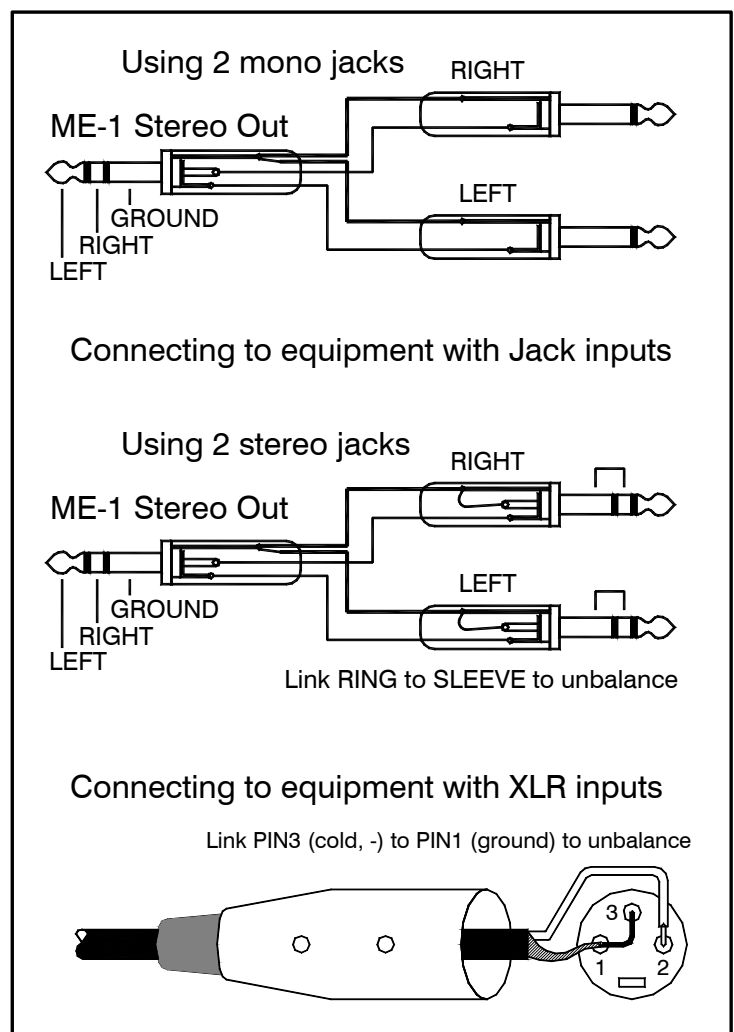

Connecting a mono source:

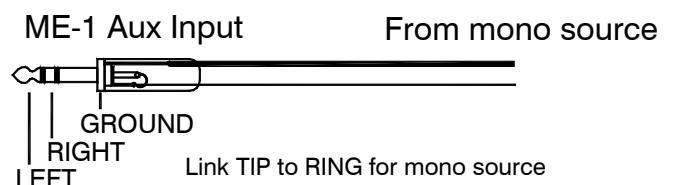

7. Operating ME-1

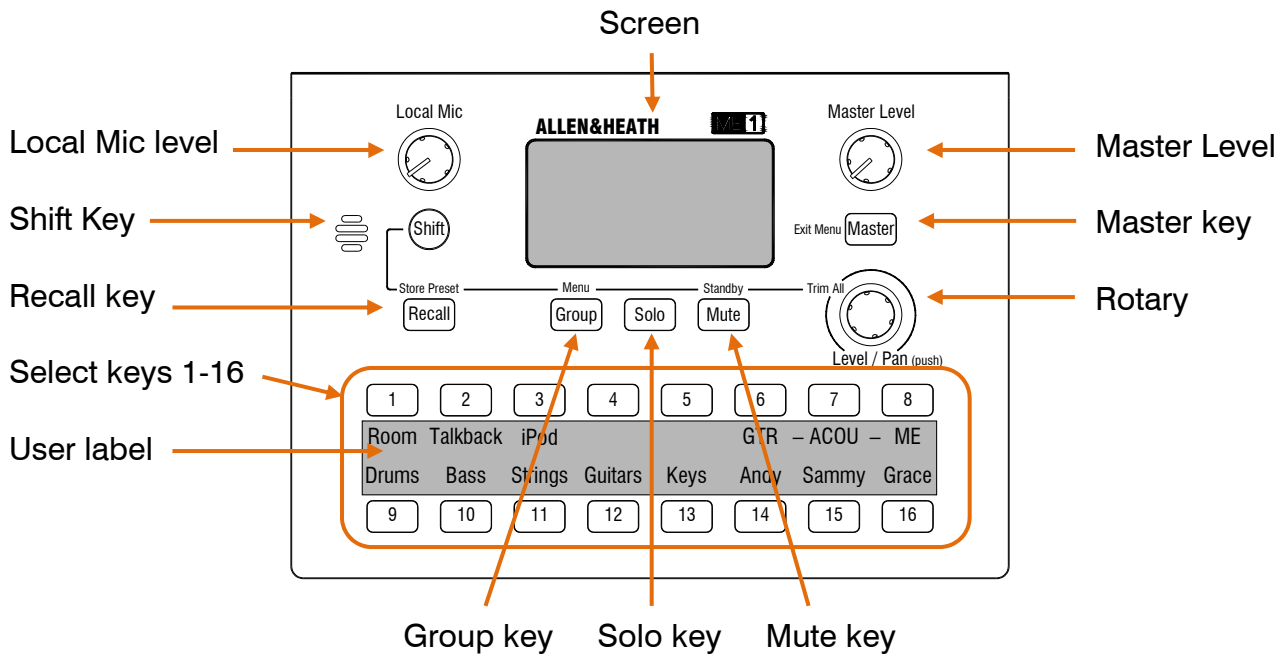

7.1 Turning the mixer on or off

To turn the mixer on - Plug the external PSU into the DC In socket or a Cat5 cable from a PoE switch or ME-U hub into the Link In socket.

The **Home** screen is displayed and the keys illuminate so they can be seen in dim lighting. ME-1 starts in **Normal mode** with previous settings restored and all keys turned off.

To turn the mixer off - Unplug the DC cable or the Link In Cat5 cable if you are using PoE.

Note Removing power will turn off audio to other mixers in the chain if they are daisy chained from the Link Out socket.

7.2 Standby

Use Standby instead of turning the mixer off when you leave it unattended. This locks the controls and mutes the audio. The screen displays a moving Config Name to identify the mixer.

To enter Standby - Hold Shift and press the Mute key. Press both keys again to exit.

7.3 Operating modes

Normal mode - Press a Select key to access level, pan and mute for a source. Press the Master key to access the mix EQ and limiter.

Group mode (Group key flashing while a group is selected) - Scroll through and adjust level and pan for members of the group.

Solo mode (Solo key flashing or held) - Listen to individual sources in the mix.

Recall mode (Recall key held) - Overwrite current settings with the contents of a preset stored in the mixer or from a USB key.

Store mode (Shift+Recall) - Store the current settings to a preset or USB.

Setup mode (Shift+Group) - Access the dimmer, about and setup screens.

Standby mode (Shift+Mute) - Lock the settings and mute the audio.

7.4 Rotary control

Turn - Adjust level, EQ gain, limiter or scroll through a menu. Value shown on the screen.

Press and turn - Adjust pan or EQ freq.

Press Shift and turn - Trim all source levels or all levels within a group.

Press - Select a member in a group or select a menu option.

7.5 Screensaver

Displays a moving Config Name if the keys or rotary are left untouched for more than 10 minutes. Audio is not affected. Operate any control to instantly access its function. Press Shift to exit without changing function.

7.6 The Home screen

The mixer starts in the Home screen:



Displays the **Config Name** to identify the mixer or user. Displays the name of the **Last Preset** recalled during the session. Blank after power up or if none have been recalled.

7.7 Stereo Meter

Displays the signal before the Master Level control. In **Normal** mode it shows the combined mix level. In **Solo** mode it shows the level of the selected source.

'PK!' turns on 3dB before clipping to warn that the signal is too hot and may distort if turned up much higher. 'L' turns on when the limiter is preventing the signal getting any louder.

Optimum meter reading – Adjust levels for a reading without 'PK!' or 'L' turning on for loudest moments. Turn down source level or use the Trim All function to simultaneously reduce all levels if 'Pk' or 'L' flash.

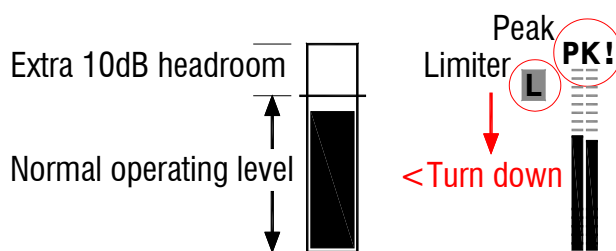

7.8 Adjusting Master Level

Turn the Master Level control to adjust output volume. This is a global control that is not stored with presets. It affects the mix level but not the local mic level. The meter is pre-level so is not affected by this control.

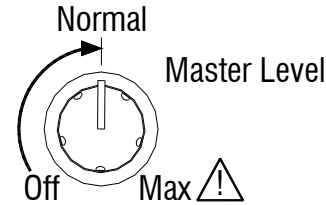

Start with the Master at minimum. Adjust sources for optimum meter reading then turn up the rotary for comfortable listening level. Typical setting is around mid-position.

Warning To avoid the risk of hearing damage do not operate at high volumes for an extended period of time.

7.9 Adjusting Local Mic level

Turn up the Local Mic control to add ambient stage sound from the built-in microphone to your headphones or in-ears, and hear fellow musicians who come up and talk to you..

Local Mic level is not stored with presets and is not affected by the Master Level nor shown on the meter. The mic signal is sent to the stereo output only.

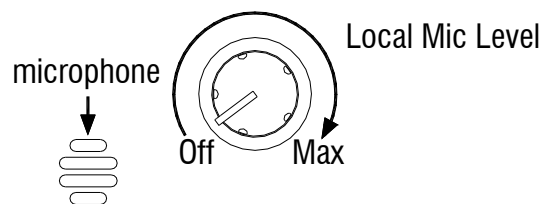

Start with the Local Mic level at minimum. Set and leave it or turn it up only when you need to hear somebody talking to you.

Note To avoid feedback do not place your headphones next to the built-in mic while it is turned up.

Note The Local Mic is for stage sound and is not intended for adding audience ambience or communicating with other musicians over the CAT5 link.

Note If you do not hear sound the Local Mic may have been disabled (muted) in Setup.

7.10 Selecting sources

Press a Select key. Depending on how it is assigned the following screens may appear:

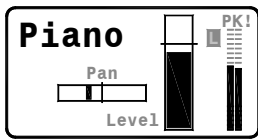

Channel source – One of the 40 Cat5 inputs. Level and pan are available

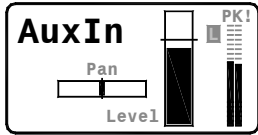

Aux Input – From rear panel stereo input socket. Level and balance are available.

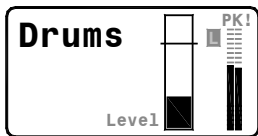

Group – Key is a group with multiple channels assigned as its members. Group master level available.

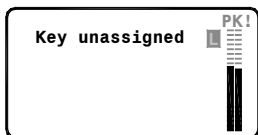

Unassigned – There is no source assigned to the key.

7.11 Adjusting Level and Pan

Select a source:

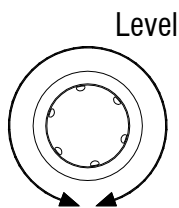
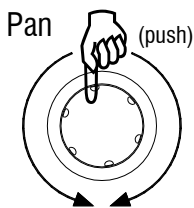
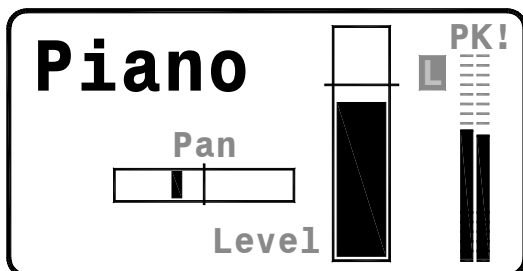

Level - Turn the rotary to adjust level from fully off through nominal '0' at the marker to +10dB gain available as headroom.

Pan – Press and turn the rotary. Pan positions a mono source between Left and Right, and adjusts the balance between Left and Right of a stereo source.

Note Pan is not available for groups. However you can adjust pan for each of the members within a group.

If a channel is assigned to a Select key and is also a member of a Group then a pointer on its level bar shows the current group master level setting:

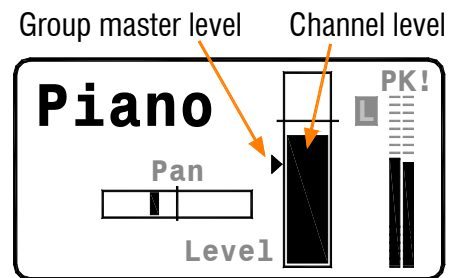

The channel Select key level and the level of its member within the group are the same.

Note If you turn up the channel and do not hear the audio check that the associated group master is turned up.

7.12 Trimming All levels

Hold Shift and turn the Rotary to simultaneously trim all levels up or down.

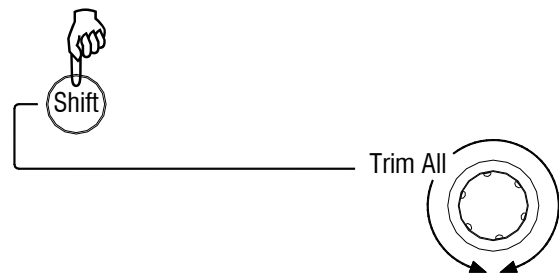

Use Trim All to reduce a hot mix if 'PK!' or 'L' flashes, to bring up a mix with low meter reading, or to turn all levels off.

In **Normal mode** Trim All adjusts all Select key levels. It adjusts group masters and not their source members.

In **Group mode** Trim All adjusts the levels of just the members within the selected group.

Note The mix balance will change when the source with highest level reaches maximum or source with lowest level reaches minimum. Use Trim All carefully to make small adjustments if you want to keep the relative balance between the sources.

Using Trim All to turn off all levels – Select the source with highest level setting. Hold Shift and turn the Rotary anticlockwise several times to reduce it to off. You can reset the whole mix or just a group in this way.

7.13 Muting a source or master

Press a Select key or the Master key.

Press the Mute key to turn the selected audio on or off. The key lights red when the source is muted.

If a source is muted but not selected its Select key flashes to remind you that it is muted.

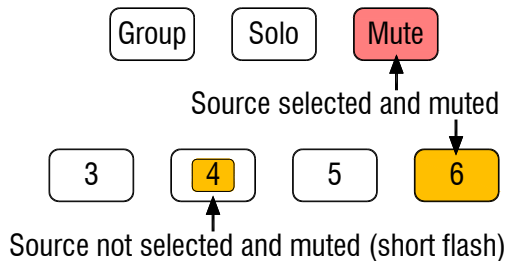

Note Muting a source here will only mute it locally. It does not mute it on other ME-1 mixers in the system.

It is typical for the sound engineer to mute sources at the main console to affect all ME-1 mixers, for example when a musician plugs in a different guitar.

7.14 Using Solo to listen to sources

Select a source.

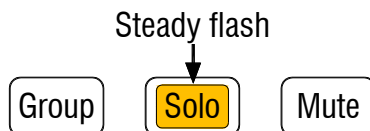

Latched Solo mode:

Press and release the Solo key.

The Solo key flashes steadily while in **Solo mode**. All audio is muted except for the selected key. You can listen to its contribution to the mix and check its meter level.

Press other Select keys to solo different sources. When you are finished press the select key again or Solo again to return to **Normal mode**.

Momentary Solo mode:

Press and hold the Solo key. It will stop flashing and turn on under your finger indicating it is in momentary mode. Release the key when you are finished listening to the selection.

7.15 Adjusting Group master level

Adjust the overall group level.

Select a source. If it is assigned as a group then the Group key will light and its master level screen appear:

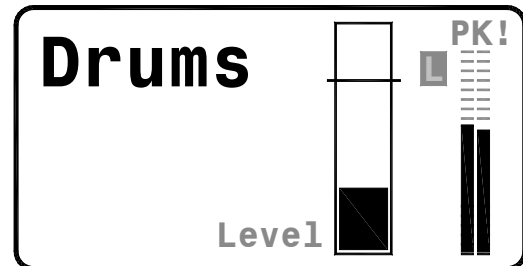

Turn the Rotary to adjust the group master level from fully off through nominal '0' at the marker to +10dB gain.

Note The group master level must be turned up for its source members to be heard.

7.16 Adjusting Group source levels

Adjust level and pan of group members.

With a group selected press the Group key to enter **Group mode**.

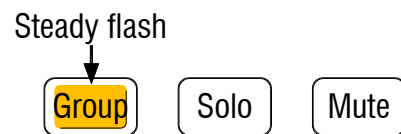

The Group key flashes and a list of sources assigned as members of the group is shown:

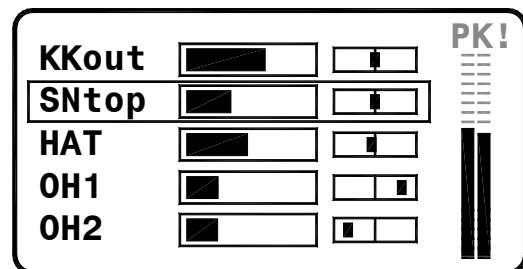

Turn the Rotary to scroll through the members to find the one you want to adjust. Press the Rotary to select it:



Turn the Rotary to adjust the member Level. Press and turn the Rotary to adjust its Pan. Press the Group key to exit.

7.17 Adjusting the Master EQ

Press the Master key. The mix master 3-band EQ curve and Limiter settings are displayed:

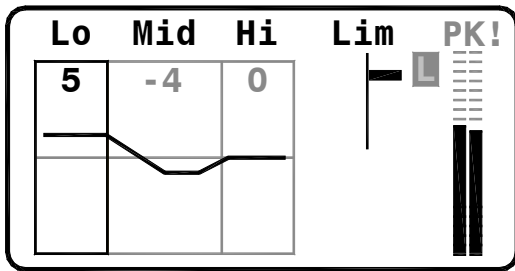

Turn the Rotary to scroll through the available settings and highlight the EQ band you want to adjust. Press to select it.

Turn the Rotary to adjust the amount of cut or boost. A straight line indicates flat response.

Press and turn the Rotary while the Mid band is selected to sweep its centre frequency.

Using the EQ – Start with the EQ flat. Avoid using extreme cut or boost.

7.18 Adjusting the mix Limiter

Press the Master key.

Turn the Rotary to highlight Lim, then press to select the setting. Turn to adjust the point at which limiting starts from 0dB (no limiting) with the pointer at the top to -24dB (maximum limiting) at the bottom.

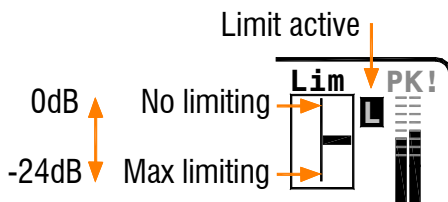

Using the Limiter – Start with the Master Level set to normal operating position for your headphones and the limiter set to the top of the scale (no limiting).

With the highest signal and meter reading you expect during performance, for example your loudest vocal moments, turn the Rotary up until the limiter 'L' just starts to flash.

Note The limiter can prevent unexpected loud moments in the mix. The Master Level control sets the overall volume to suit the type and sensitivity of the headphones or ear pieces you are using.

7.19 Presets

ME-1 provides up to 16 presets.

Each Select key can be assigned a preset mode by the system engineer to allow store and recall or recall only.

Presets can also be stored to and recalled from USB key and transferred between ME-1 mixers.

A Preset stores:

- Key setup – Source and name
- Group members
- Input levels, pan and mutes

A Preset does not store key preset mode, Master EQ, Limiter or Solo settings, or Local Mic and Master Level.

7.20 Recalling a Preset from a key

Hold down the Recall key.

Select keys light to show preset status:

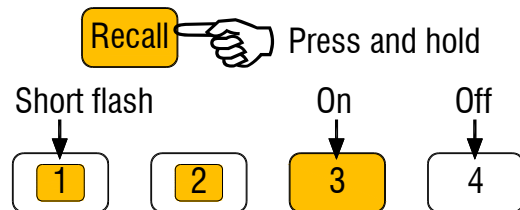

Off – Preset is blank.

On – Last preset recalled.

Short flash – Preset available to recall.

While holding Recall press a Select key. The screen displays the available preset number and name. The key flashes to show it is selected ready for recall.

Recall: Preset4

Press again to recall

SONG4

Press the Select key again to confirm the recall. The current settings are overwritten with the contents of the preset.

Release the Recall key to exit.

7.21 Recalling a Preset from USB

Hold the Recall key.

If a USB key is plugged in then a list of presets found on the key will be displayed:

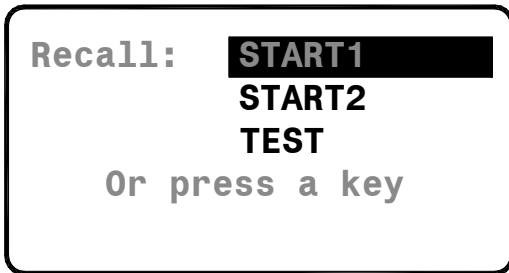

While holding Recall turn the Rotary to scroll through and highlight the preset to recall.

Press the Rotary to select the preset. Press again to confirm the recall.

Release the Recall key to exit.

7.22 Storing a Preset to a key

Hold Shift and press the Recall key to enter **Store mode**.

Select keys light to show preset status:

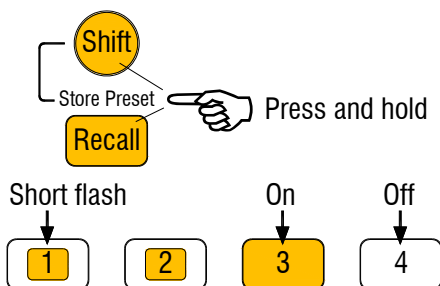

Off – Key set for or recall only.

On – Last preset stored.

Short flash – Preset available for store.

Press a Select key. The screen displays the available preset number and name. The key flashes to show it is selected ready to store.

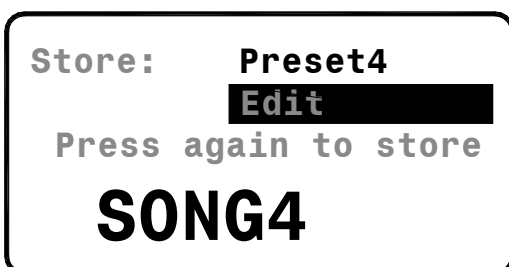

Press the key again to overwrite the preset with the current settings.

Once stored the ME-1 exits **Store mode**.

7.23 Storing a Preset to USB

Hold Shift and press the Recall key to enter **Store mode**.

If a USB key is plugged in then the 'To USB' item will be highlighted on the screen:



Press the Rotary to select the USB key. Press the Rotary again to store a preset with the name displayed to USB.

Select the 'Edit Name' item if you wish to change the name before storing the preset to USB.

Note If the name is blank then the preset will be stored to USB key with the default 'PRESET' name.

Once stored the ME-1 exits **Store mode**.

7.24 Editing a Preset

While in **Store mode** press the Select key for the preset you wish to edit.

Press the Rotary to open the **Edit** screen:

- Name with up to 8 characters
- Clear the name
- Clear the preset contents and name

To name the preset – Use the Rotary to scroll to the character to edit. Press it again to select it and scroll through the available characters. Press again and scroll to another character.

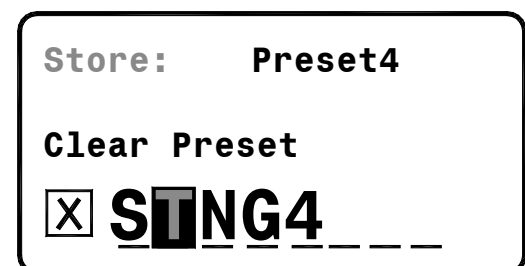

Available characters for preset naming are:
0-9, A_Z, space

To clear the preset name – Scroll to the **X**.
Press the Rotary to clear all characters.

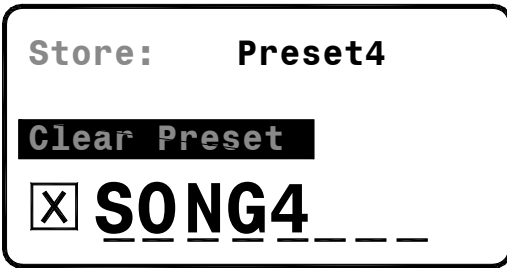

To Clear the preset contents and name –
Scroll to Clear Preset and press the encoder.

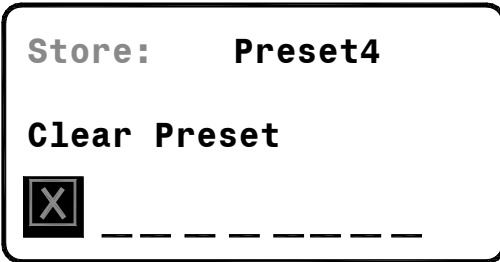

Clearing a preset clears its contents and resets its name to blank (no name).

If you attempt to recall a preset that has been cleared then a 'Preset is blank' message will appear.

Note We recommend you clear presets you do not need to prevent accidental overwriting of your settings.

To exit the Edit menu – Press the Master key to return to the **Store** screen.

Hold Shift and press the Recall key to exit **Store mode**.

8. Setting up ME-1

The system engineer configures ME-1 to suit the operating requirements of the user.

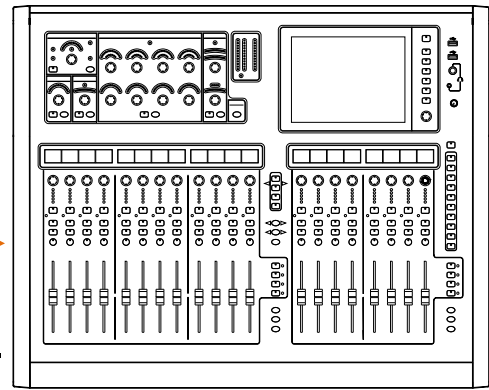

USB key:
Transfer presets
Export/import config
Update firmware



Patch mixer outputs
Link channels as stereo
Name channels

Screen

Press Shift +
Group to enter
Setup Menu.

Press Group to
exit Setup Menu.

Fit user label

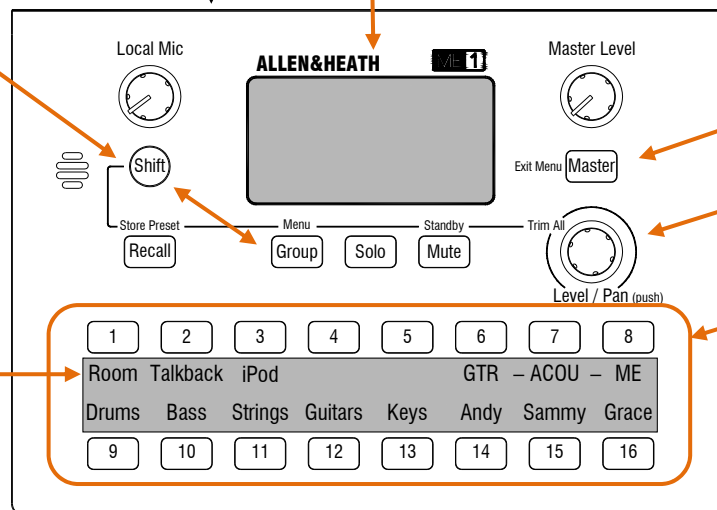

Menu navigation:

Return to previous

Scroll selection or
value. Push to select.

Press to assign keys:

Source

Name

Preset mode

8.1 Patching mixer outputs to ME-1

Depending on the connected source you can patch up to 16 or 40 channels, set stereo links and send channel names. Examples:

Channels – Typically Direct Outputs set post-EQ, pre-Compressor, pre-fader, post-mute.

Link – Assign odd/even as stereo pairs.

Groups – Mono or stereo groups if you prefer to combine sources at the main console.

Auxes – Mono or stereo auxes to create an independent balance at the main console.

Main mix – To send the console FOH mix.

FOH effects – Combine main mix FX returns via a stereo Group to send to the musicians.

'My' effects – Set up an available FX at the console dedicated to one musician, for example reverb for a lead vocalist. Return via channel Direct Outputs or a stereo Group.

Ambient mics – Set a stereo pair of channel Direct Outputs for room microphones.

Talk – Talk to musicians via a mono Aux or a spare channel Direct Output.

GLD dSNAKE or MONITOR port

40 channels + stereo links + names

Use the **I/O / Monitor** screen.

Qu Series dSNAKE

40 channels + stereo links + names

Use the **Setup / Output Patch** screen.

iLive Port B ACE direct to ME-1

40 channels (no stereo links or names)

Use the **Outputs / Port B:ACE** screen 21-60.

iLive Port B via ME-U hub

40 channels + stereo links + names

Connect Network for stereo links and names.

Use the **Outputs / Port B** screen 21-60.

iLive MMO Aviom® port

16 channels + stereo links (no names)

Use the **Outputs / Port B:MMO** screen.

Other via ME-U hub (48kHz)

Up to 40 channels + stereo links + names

PC > Network for stereo links and names.

Card option – Dante, MADI, EtherSound

8.2 Setup mode

Hold Shift and press the Group key to enter the Setup Menu:

```
Dimmer
About
Key Setup
System Setup
Press Group to exit
```

Use the Rotary to scroll through the list and press to select a menu item.
Press the Master key to return to the previous screen.
Press the Group key to return to **Normal mode**.

8.3 Adjusting the brightness

Scroll to the Dimmer menu:

```
Dimmer
About
Key Setup
System Setup
Press Group to exit
```

There are two settings. Press the Rotary to toggle bright or dim. The dimmer affects the screen and key brightness.

8.4 The About screen

Select the **About** screen:

```
Config: MATT
Unit: MM4
Firmware: V1.00r9057
Mac: 00:04:C4:00:73:3A
```

This screen displays information about the ME-1 mixer:

- Current Configuration name (the settings)
- Current Unit name (the mixer)
- Current operating Firmware version
- MAC address (factory programmed)

8.5 Assigning Key Sources

The audio source for each of the 16 Select keys can be freely assigned to suit your application.

Select the Key Setup **Source** screen:

```
Source: Unassigned
Name:
Members:
Preset: StoreRecall
```

A list of available sources is displayed. Use the Rotary to scroll through and press to select the required source:

```
Source:  Unassigned
 Group
 Aux Input
 Auto Mode
 1kHz Sine
```

Unassigned – The key does not select any audio source. Choose when you want to leave keys unused or used for presets only.

Group – Sets the key to be a group with a master affecting the overall level of all channels assigned as its members. For example a 'Drums' or 'Vocals' group.

Aux Input – Selects the local stereo line input available on the rear of the mixer.

Auto Mode – The key automatically assigns the first available channel not already assigned.

1kHz Sine – A sine wave tone for testing and setting levels of equipment connected to the ME-1 outputs.

Channels 1-40 – Assign an individual source to the key from one of up to 40 channels received via the Cat5 cable.

Note Stereo channel pairs assign to single keys if stereo link data is received from the connected source (GLD, ME-U, Aviom®).

Note The source list will display channel names if these are received from the connected source (GLD, ME-U).

8.6 Auto Names and Stereo linking

Names

Channel names created at their source and sent via the Cat5 cable can be detected and used by the ME-1 mixer.

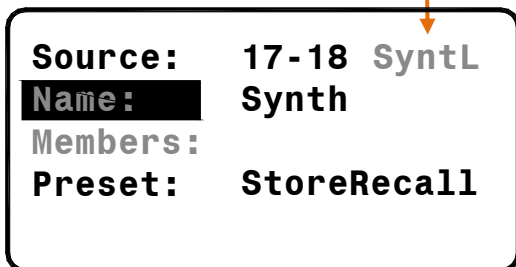

The ME-1 displays the received name in the Key Setup screen. This is used as the 'Default' name. Alternatively, custom key names can be created and stored in the ME-1 mixer.

Examples:

Bass - If a name is available from the source then the ME-1 will display this as the Default.

IP5 or **Aux2** – If a name has not been applied or has been reset at the source then the ME-1 will display channel type and number.

Unused – If the channel has been unassigned at the source then the ME-1 will display this label.

5 – If the auto name is not available then the channel number will be displayed instead.

Stereo Links

Odd/even channels may be linked as stereo pairs at their source before being sent via the Cat5 cable to the ME-1.

This lets you assign a stereo linked pair to just one key. For stereo pairs, Pan becomes a Balance control to adjust the relative left and right signal levels.

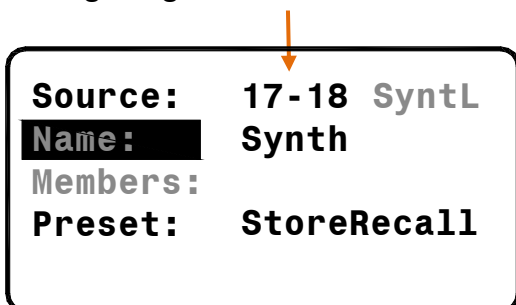

Only the odd (left) channel of a linked pair is shown in the Key Assign and group Members lists.

Stereo linked channel examples – Link sources such as stereo keyboards, effects returns, audience microphones.

Auto names and stereo linking are available from:

✓✓ = Names / Links



✓✓ **dSNAKE port** – Any available dSNAKE or Expander port at the surface or rack,

✓✓ **AR2412 Monitor port** – Operating in either ME-1 (40 channel) or Aviom® (16 channel) mode,

✓✓ **AB168 Expander port**

✗✓ **I/O Port MMO card** - Aviom® port (16 channels) [Stereo links only]



✓✓ **Port B ACE via ME-U hub** – Using two cables, one for ACE to the hub input (audio) and the other connecting the Network (stereo linking and names).

✗✗ **Port B ACE** (without ME-U) - Stereo linking and names are not available from iLive when connected directly to ME-1 via ACE.

✗✓ **iLive Port B MMO card** - Aviom® port (16 channels). Aviom® mode only [Stereo links only].

Note If you are connecting ME-1 directly to ACE and therefore have no network link, you can clear any previously received stereo links and names in the ME-1 using its Menu screen **System Setup / Reset Source List** function.

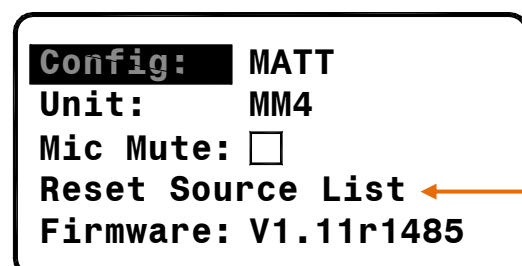



Names and stereo links are available from all Qu system dSNAKE ports:

✓✓ **dSNAKE port** – If it is not being used for digital snake connection to a remote rack.

✓✓ **AR2412 Monitor port,**

✓✓ **AB168 Expander port**



The ME-U hub interfaces audio from a digital network to multiple ME-1 mixers. Inputs can be sourced from dSNAKE, ACE, Dante or MADI.

Input Option card –Availability of remote names and links depends on the option card fitted and mixer connected:

✓✓ **ME-D** – For connection to Qu dSNAKE.

✓✓ **ACE** –The ME-U hub can get names and stereo links from GLD or iLive via ACE only if a second Cat5 cable links its Network port to the mixer Network port.

Note If you link the network make sure the ME-U hub and mixer have compatible IP addresses.

✓✓ **Dante option fitted to GLD or iLive** – The ME-U hub can get names and stereo links from the mixer if a second Cat5 cable links its Network port to the mixer Network port.

✗✗ **Dante from third party source** – Audio only.

✓✓ **MADI option fitted to GLD or iLive** – The ME-U hub can get names and stereo links from the mixer if a Cat5 cable links its Network port to the mixer Network port.

✗✗ **MADI from third party source** – Audio only.

Note ME-U supports 48kHz MADI only.

Local at ME-U

✓✓ Names and stereo linking can be assigned locally at the hub to feed all connected ME-1 mixers.

Other Sources

ME-1 can be connected directly to:

✗✓ **Aviom® A-Net 16** – Any third party system providing an Aviom® output (16 channels) with stereo link capability. Names are not available.

Note Power over the Cat5 cable (PoE) is not available if you are connecting via an Aviom® hub. Use the power unit provided with the ME-1 mixer.

8.7 Setting up Groups

Any Select key can be assigned as a Group. This means you can set up to 16 groups.

You can assign any number of the 40 channels as 'members' of a group.

Note A channel can be assigned to only one group. However, it can also be assigned as a single source to any key.

First, assign Group as the key source. Then scroll to and select the **Members** screen:



Source: Group
Name: Drums
Members: 7x
Preset: StoreRecall

The members list will display channel numbers or names if these are received from the connected source:



Member: None
 KKin
 KKout
 SNTop
 SNbot

To assign a channel - Use the Rotary to scroll through the list and press to select.

To assign a range of channels - Hold Shift and turn the Rotary. Press to toggle these in or out of the group.

To clear all assignments – Select None and confirm by selecting OK.

Press the Master key to return to the Key Setup screen.

Working with groups – After assigning a key as a Group its master level will default to the '0' position as a starting point.

Use **Group mode** to select and adjust Level and Pan for each of its member channels. Once adjusted it is typical to let the musician work with just the group master level rather than adjusting sources within the group.

8.8 Key assignment Auto Mode

The ME-1 can automatically assign available Cat5 channel sources to its keys. One or more keys can be assigned to Auto Mode.

Select Auto Mode in the Key Setup **Source** screen:

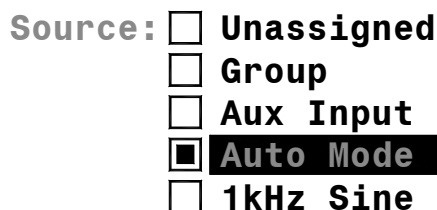

Source: Unassigned
 Group
 Aux Input
 Auto Mode
 1kHz Sine

Auto Mode is most effective when the ME-1 is able to detect stereo linking and channel names.

Auto Mode – The key looks for the first available channel that is:

- Not already assigned to another key
- Not a member of a group
- Not unassigned at source

It assigns stereo linked sources to single keys.

Note - Auto Mode refreshes each time the ME-1 is powered up or the Cat5 cable unplugged and then replugged.

Working with Auto Mode

At the source (GLD, iLive or ME-U):

1. Apply stereo linking and channel names.
2. Connect the Cat5 cable to the ME-1.

At the ME-1:

3. Assign any fixed key sources you need.
4. Assign any groups you need.
5. Assign the other keys for Auto Mode.
6. Repower the ME-1 to start auto assign.
7. Press Select keys to check assignments.

Assigning some or all 16 keys to Auto Mode can provide a quick way to configure the sources.

The ME-1 hard reset and factory default 'ME' configuration sets all 16 keys to Auto Mode.

8.9 Assigning key Names

Scroll to and select the **Name** screen:

Source: 17-18 SyntL
Name: Synth
Members: StoreRecall
Preset: StoreRecall

The current source and name are displayed. In the above example:

17-18 = CH17 and 18 stereo linked at source

SyntL = The name received from the source

Synth = The custom name applied to the key

To edit the name:

Name: 17-18 SyntL
 Default
 Custom
Synth

Select Default to use the channel number or the name detected from the source (GLD or ME-U).

Select Custom to edit and apply a local name with up to 6 characters to the key:

Name: 17-18 Synth
 Default
 Custom
X Nord

Use the Rotary to scroll to the character position. Press to select, then scroll through and select the required character.

Select the **X** to clear the current name.

Available characters are:

0-9, A-Z, a-z, space

Press the Master key to return to the Key Setup screen.

8.10 Assigning key preset mode

Scroll to the Preset item:

Source: Group
Name: Drums
Members: 7x
Preset: Recall only

A preset is available at each of the 16 keys. Each can be set for one of two operating modes. Press the Rotary to toggle mode.

- Store/Recall – Able to store and recall, or
- Recall only – Not able to store.

Press each key in turn to set the option.

Press the Master key to exit the menu.

A Preset stores:

- Key setup – Source and name
- Group members
- Input levels, pan and mutes

A Preset does not store key preset mode, Master EQ, Limiter or Solo settings, or Local Mic and Master Level.

Storing a starting point preset – Set the keys for Store/Recall, exit the Setup Menu, configure the settings and then name and store a preset as a starting point for the user. Several presets could be stored for different situations.

To protect a preset – Once the preset is named and stored, return to Key Setup and set the key preset mode for Recall only.

To disable a preset – Go to **Store mode**, select the key and use the **Edit** screen to Clear the preset. Now return to Key Setup and set the key preset mode for Recall only. The preset is blank and protected and therefore disabled for the key.

To allow user presets – Set keys for Store/Recall. You can also clear or name them ready for the user.

To transfer presets via USB key – You can archive individual presets on your computer or transfer them to other ME-1 mixers using the **Store** and **Recall** modes described in the Operating section of this guide.

8.11 Working with Configurations

The ME-1 Configuration stores the current settings, all assignments and all presets. Hold Shift and press the Group key:

```

Dimmer
About
Key Setup
System Setup
Press Group to exit
    
```

Select System Setup:

```

Config: MATT
Unit: MM4
Mic Mute: 
Reset Source List
Firmware: V1.11r1485
    
```

Select the **Config** screen to change the name of the configuration, and to export or import a configuration file via USB key.

```

Name MATT
Export No USB key
Import No USB key
    
```

You can apply a Config name with up to 8 characters to displays on the **Home** screen, the screensaver and also in **Standby** mode. This also becomes the name of the config file transferred via USB key.

```

Name: MATT
    
```

```

[X] EL _ _ _ _ _
    
```

Select the **X** to clear the current name.

Available characters are:

0-9, A-Z, space

Press the Master key to return to the Config screen.

Exporting the Config file – Plug in a USB key. Check the key is recognised.

```

Name MATT
Export To USB
Import From USB
    
```

The ME-1 will automatically create a ME1CFG folder on the USB key if one does not already exist.

Edit the Name if you want to change it. Select Export and OK on the confirmation screen.

Note The export will overwrite any existing config file with the same name on the USB key.

Importing a Config file - Plug in a USB key with the required file in the correct folder. Check the key is recognised.

```

Import: ME
        DEMO
        MATT
    
```

Scroll through the list of Config files found on the USB key. Press the rotary to select the file and select OK on the confirmation screen.

Note Importing a Config overwrites all ME-1 settings and presets. If you wish to save your settings first export the current config to USB.

Working with Configurations – You can set up one ME-1 mixer and store all its settings and presets as a Config file, and export this to USB key. Use this to archive your setup on computer, or to copy to other ME-1 mixers as a starting point for editing. This provides a very quick way to set up multiple mixers for personal monitoring.

Note You can also store and recall individual presets directly to or from the USB key. This provides a quick way of copying settings between mixers without overwriting all their presets and current assignments.

8.12 Changing the Unit Name

The ME-1 mixer can be given a Unit name to identify the hardware. Hold Shift and press the Group key to open the Setup Menu.

Scroll and select System Setup:

```
Config: MATT
Unit: MM4
Mic Mute: 
Reset Source List
Firmware: V1.11r1485
```

Select the **Unit** screen to set the unit name.

```
Mac: 00:04:C4:00:73:3A
Name:  Default
      Custom
00:73:3A
```

Each ME-1 mixer has a unique MAC address to identify it on a network. This is factory set and cannot be changed.

There are two options for Unit name:

- Default = Last part of MAC address
- Custom = Enter up to 8 characters

To set a custom Unit name:

```
Mac: 00:04:C4:00:73:3A
Name: Default
       Custom
[X] MM4 _ _ _ _ _
```

Use the Rotary to edit the name. Select the **X** to clear the current name.

Press the Master key to return to the System Setup screen.

Note The Unit name is not affected when a Config is imported. However it is reset to Default if you perform a power up reset.

8.13 Local Mic Mute Option

The built-in local mic is useful to add stage sound to the mix or to hear fellow musicians when they walk up and talk to the user. If you do not need this function then it can be disabled by setting the Mic Mute option.

Factory default is Mic Mute turned off.

Scroll and select System Setup:

```
Config: MATT
Unit: MM4
Mic Mute: 
Reset Source List
Firmware: V1.11r1485
```

Select the **Mic Mute** item. Press the rotary to toggle the option on or off.

8.14 Updating the ME-1 firmware

The operating firmware can be updated using a USB key. Check the Allen & Heath web site for the latest version available.

Update all the ME-1 units in your stock.

Copy the new firmware to USB key –

Download the firmware file, unzip it and copy its ME1 folder to the root of your USB key.

Safely Remove/Eject the USB key from the computer.

Update the firmware – Plug the USB key into the ME-1 rear panel USB port.

Hold Shift and press the Group key to open the Setup Menu. Scroll and select System Setup. Select the **Firmware** page.

```
Current: V1.01r11277
On USB: V1.23r12345
```

**To keep settings first
export Config to USB**

Press the Rotary to select the new firmware. Use the confirmation screen to start the update. The ME-1 reboots with the new firmware loaded in a few seconds.

9. Reference

9.1 Working with USB keys

We recommend that you start with a reformatted USB key.

Check the key - Plug in and check that the key is recognised by the ME-1. To do this press the Recall key. The screen should display a list of presets already on the key or the following message if blank:

Recall:

No USB Presets

+Press a key

Folders - ME-1 automatically creates folders in the root directory of the USB key when it is plugged in:

ME1CFG	For configuration files
ME1PST	For presets

Files - Config and preset files have the same .ME1 extension and must therefore be placed in their correct folders if you copy them between computer and USB key.

Files can be identified by their size:

Preset =	4KB
Config =	72KB

The files are not time stamped as ME-1 does not have a built-in clock.

File names – ME-1 uses 8.3 short file names. It will not recognise file names longer than 8 characters. It will convert lower case characters to upper case.

ABCD5678.ME1

Therefore if you wish to rename files on your computer before transferring them to ME-1 mixers make sure the names are no longer than 8 characters and comprise the following character set:

0-9, A-Z, space

9.2 To Reset the ME-1

To perform a hard reset:

Hold down the Shift + Recall + Master keys and power up the mixer. Release the keys once the following screen appears. Confirm to reset the mixer.

Reset System?

This will clear all!

OK

Cancel

Resetting the ME-1:

- Assigns all keys to Auto Mode
- Assigns all keys for preset Store/Recall
- Assigns all key names to default
- All levels off, pans mid, mutes off
- All presets blank (cleared)
- Config name = DEFAULT
- Unit name = default (MAC address)

9.3 To Reset auto Names and Links

Names and stereo links received from the source can be cleared. To do this: Hold down Shift and Group to enter the **Menu** screen. Scroll and select System Setup. Scroll and select Reset Source List.

Config: MATT

Unit: MM4

Mic Mute:

Reset Source List ←

Firmware: V1.11r1485

Note If you are connecting ME-1 directly to a source that does not have name and link data, you can clear any previously received names and stereo links using this function.

9.4 Specification

Stereo Out – Stereo ¼” and 3.5mm jacks for:

Headphones >16 Ω , power 300+300mW
into 100 Ω load, or line out max +21dBu

Mono Out – Balanced TRS jack, nom 0dBu,
max +18dBu

Aux Input – Stereo 3.5mm jack, nom -8dBu,
max +10dBu, impedance >10k Ω

Residual Output Noise - -95dBu (level min)

Freq Response - +0/-1dB 10Hz to 20kHz

Mains Power Unit – 100-240V AC 50/60Hz,
+12V DC 1.25A out

PoE Requirement – 10W at ME-1 (We
recommend 15W at PoE hub)

Dimensions – Width x Depth x Height
225 x 150 x 55mm (8.9” x 5.9” x 2.2”)

Weight – 900g (2lbs) inc phones hook