



- /// XGA 6000 Lumens
- /// Lens shift
- /// Interchangeable Lenses
- /// Full 3D Support

X605

*Spectacular image quality, outstanding
brightness and ultimate reliability*



PRO | SCENE

Features



X605 features



6000 Lumens, XGA Resolution



Installation flexibility – Lens shift, interchangeable lenses, off-axis short throw option



Ultimate Control - Full support for Crestron, Extron, AMX, PJ-Link and Telnet LAN commands



Powerful Image Blending tools - 3-axis colour matching system and 10x lamp-power steps



Advanced features – Wired Remote, Full 3D Support and DICOM simulation



Image Quality



Superb image quality is at the heart of every ProScene product design. At every step, commencing with the incredibly reliable, high resolution XGA DLP® chip where the image is initially created, via the UHP lamp pulsing technology that fine tunes the colour to exacting standards, through to the precision optics to focus the image on a screen, accuracy and integrity of the image are paramount.

ProScene chose DLP® technology for its image quality and unmatched reliability. The reflective nature of DLP® micro-mirror technology provides highly efficient bright images with great contrast whilst maintaining precise colour accuracy and natural, real-world colour reproduction. For demanding professional applications, the proven reliability of DLP® technology makes it the obvious choice.

DLP® Technology

DLP® technology from Texas Instruments® is widely recognised and acclaimed for its unmatched reliability and long lasting image performance. When combined with high brightness and native contrast ratios, it becomes the obvious choice for demanding applications. Independent testing has proven DLP® to be the most reliable of projector technologies. Whilst other technologies may show image quality decline after only a few thousand hours, DLP® technology can remain unchanged over hundreds of thousands of hours.



Amazing Colours

The X605 incorporates BrilliantColor™ technology to produce stunningly bright images with perfectly balanced life-like colours.



UHP lamps

The 370W UHP lamp provides the highest possible luminance, the essential prerequisite of all highly efficient projectors.

These lamps have outstanding brightness, stay brighter for longer, and provide an optimal colour spectrum. In addition, the lamp drivers are specifically tuned for the lamps, ensuring not only optimum operating conditions for every situation, but also provide sophisticated lamp pulsing modes and the assurance that colour can be fine-tuned according to the application.

Clear, Focused Images

DarkChip3™ technology from Texas Instruments produces a stunning 2000:1 contrast ratio for pin sharp graphics and crystal clear text. Crisper whites, ultra-rich blacks makes images come alive and text easier to read.



2000:1 Contrast Ratio

Flexibility



Installation Flexibility

To help meet the seemingly limitless challenges of ProAV installations, the X605 provides multiple lens options with zoom and focus adjustment to ensure you can get the image size you require, while a wide lens shift range helps you get the image exactly where you want it.



Full Lens Shift

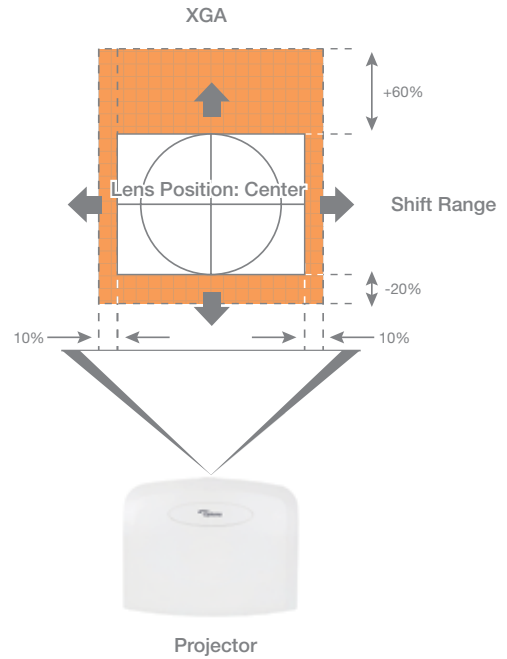

All 5 optional lenses, including the 0.8:1 short throw lens can use the full lens shift range.

Lens Options

Lens Type	Short	Semi short	Standard	Long	Extra long
Throw Ratio	0.8:1	1.14 - 1.35:1	1.6 - 2.0:1	2.0 - 3.0:1	3.11 - 5.18:1

Throw Distance Chart

X605 Throw Distance									
Diagonal Image Size (4:3)	Short	Semi short		Standard		Long		Extra long	
	Fixed (m)	Min (m)	Max (m)	Min (m)	Max (m)	Max (m)	Max (m)	Max (m)	Max (m)
50"	0.81	1.16	1.37	1.63	2.03	2.03	3.05	3.16	5.26
60"	0.98	1.39	1.64	1.95	2.44	2.44	3.66	3.79	6.32
70"	1.14	1.62	1.92	2.28	2.84	2.84	4.27	4.42	7.37
80"	1.3	1.85	2.19	2.6	3.25	3.25	4.88	5.06	8.42
100"	1.63	2.32	2.74	3.25	4.06	4.06	6.1	6.32	10.53
120"	1.95	2.78	3.28	3.9	4.88	4.88	7.32	7.58	12.63
150"	2.44	3.47	4.11	4.88	6.1	6.1	9.14	9.48	15.79
200"	-	4.63	5.47	6.50	7	8.13	12.19	12.64	20
250"	-	5.79	6.84	-	-	10.16	15.24	15.8	20
300"	-	6.95	8.21	-	-	2.19	18.29	18.96	20

For guide purposes only

Features

DICOM simulation mode

Designed specifically for larger meeting rooms and lecture theatres, the X605 includes a special DICOMsim mode that has been specifically tuned for viewing greyscale images, perfect for viewing X-rays and scans during medical training.*



*The X605 is not suitable for use in medical diagnosis.

3D Technology

Using the inherent speed of DLP® technology, Optoma Full 3D projectors can output video and images at an astonishing rate of 120Hz, allowing you to show full screen, full colour, stereoscopic 3D. The 3D effect is generated by splitting this signal into two standard video streams, one for each eye. Using DLP® Link™ technology, the 3D glasses synchronise with the image on screen to filter each stream to the correct eye. Your brain then combines the two streams to make them jump into life.

The X605 supports multiple 3D formats from various devices such as PC, Blu-ray 3D™, Sony® PS3, Microsoft® Xbox 360 or 3D TV broadcast system.

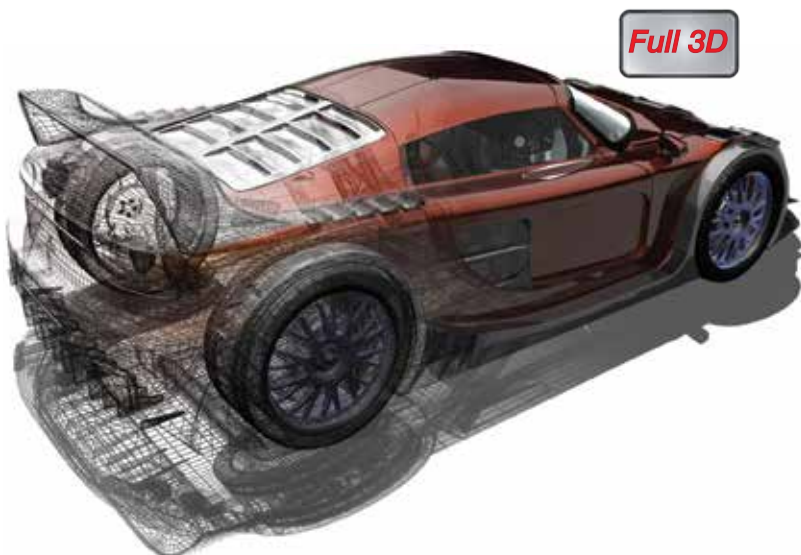

Edge Blending Tools

No two projectors are completely identical. When performing complex, or even simple edge-blend projects using multiple projectors, it can be difficult to achieve good results if the images do not match. The X605 incorporates the following features to ensure high quality and consistent results.

Colour matching

The X605 has a full 3-axis colour matching system, which combined with accurate measurements can create seamless blends every time.

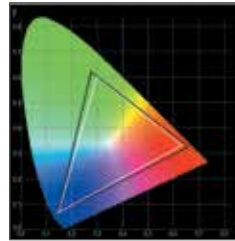

Brightness matching

The brightness of a projector will vary throughout its life. To correctly match multiple units, the X605 has 10x lamp power steps between 80~100% full brightness.



Without



With

Wired Remote

The wired remote connection allows all aspects of the projector to be individually controlled without requiring a line-of-sight to the projector; invaluable when using multiple units during live events.



Control



CRESTRON
RoomView
connected

PJLinkTM



System Integration Control

Multiple X605 can be monitored over LAN and can also provide the user with an email message alert in case an error occurs or a lamp fails or needs to be replaced using Crestron Roomview. The web browser interface and full support for Telnet, Extron's IP Link, AMX dynamic device discovery and PJ-Link protocols, allow almost all aspects of the X605 to be controlled across a network, keeping you in control, wherever you are.

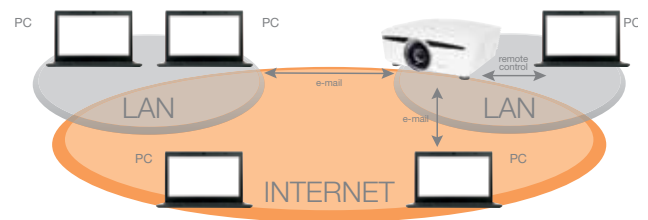
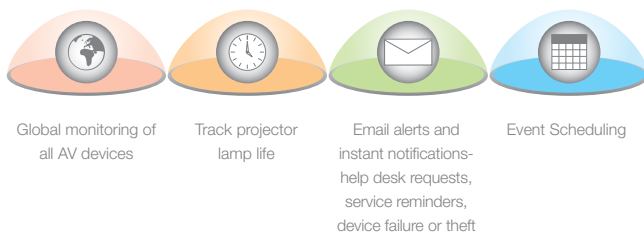

Ultimate control

Cut up to 30% from your energy bills using 24-hour automated power scheduling to ensure that projectors power off when not in use.



CRESTRON
RoomView
express

Download Crestron RoomView[®] Express for free at
www.crestron.com/getroomview

Selected View by Rooms, Attributes or Contacts

RoomView Express gives you the ability to simultaneously view more than 250 connected devices from a single screen. Customise RoomView to view by room name, locations and group.

Display Power

Check on/off status of any projector.

Display Usage

View a bar graph to monitor the percentage of available projector lamp life and set an alert to notify the services department when a replacement lamp should be ordered, before the lamp fails.

Schedule Events

RoomView Express makes scheduling of recurring or one-time events easy. Setting RoomView to automatically power down at midnight throughout the week can save valuable lamp life and ensure security inside the facility.

Event Log

Automatically generates log files, reports and charts to analyze ROI and budget allocation. Track device usage, call statistics and user history.

Eco Friendly

Cut up to 30% from your energy bills using 24-hour automated power scheduling to ensure that projectors power off when not in use.



We know that improving our products is the best way to reduce our impact on the environment. That's why at Optoma, we design our products to have a long usable life, use fewer materials, ship with the minimum packaging and be free of all possible toxic substances. Naturally, energy efficiency and being recyclable are built in at the design stage. With each new product, we strive towards minimising our environmental impact. For full details of Optoma Project Green please visit our website.



Direct Power On

The projector will start up instantly when power is supplied to the Unit. This eliminates the need to manually turn on the projector via the remote control or the keypad, ideal for use in rooms with a "master" power switch.



Signal Power On

The projector will power on when it receives a signal through one of the PC/video inputs. This ensures that the projector is only switched on when it is needed.



Auto Power Off

If after a pre-determined time the projector does not receive a signal, it will turn itself off automatically, conserving power and extending the life of the lamp.



Eco Standby Mode

Reduces energy consumption to less than 0.5W when the projector is not in use.



Eco AV Mute & Eco Sleep

Direct your audience's attention away from the screen by blanking the image when no longer needed. When Eco AV-mute is enabled, or if no source is found after 60 seconds, the projector will automatically put the lamp into Eco mode, both saving power and further prolonging the life of your lamp.



Dimensions

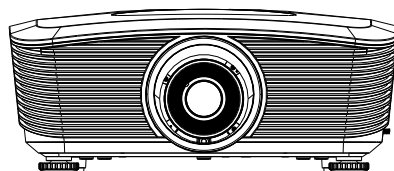
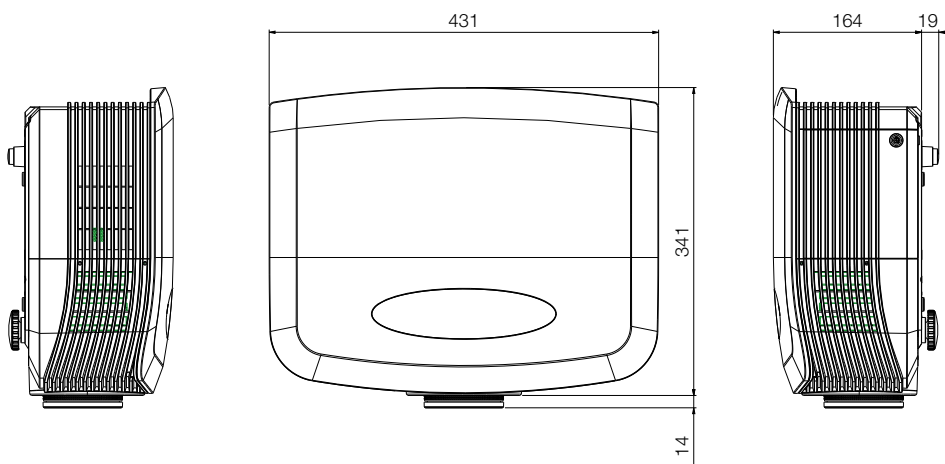
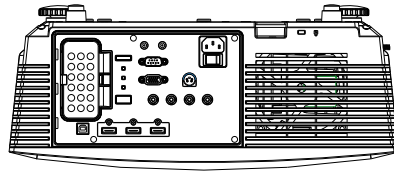

Labelling

Easy to use remote control

1. Power Off
2. Mouse
3. Function 2 (assignable)
4. AV Mute / right mouse button
5. Laser
6. Re-Sync
7. V Keystone +/-
8. Menu
9. Remote code All
10. Remote code 01~99
11. HDMI 2
12. HDMI 1
13. DVI
14. 3D Mode
15. DisplayPort
16. Component Video
17. BNC
18. Composite video
19. VGA 2
20. S-Video
21. VGA 1
22. Zoom
23. Format (aspect ratio)
24. Volume Up/Down
25. Source
26. Information Panel
27. Four Directional Select Keys
28. Display mode / left mouse button
29. Function 1 (assignable)
30. Test Pattern
31. Power On

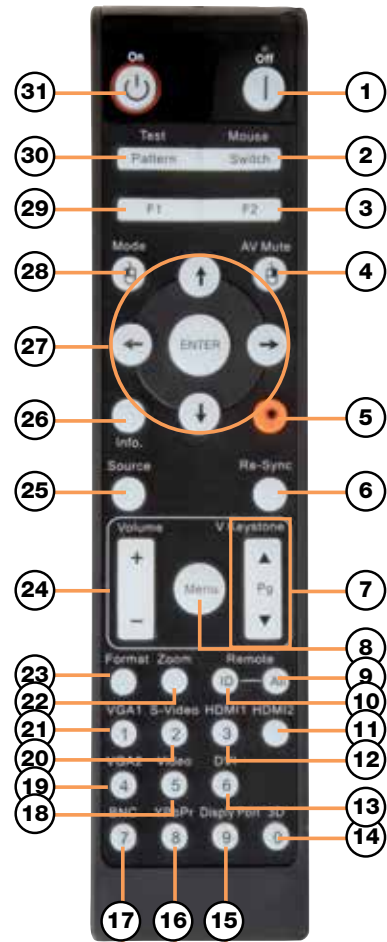

Input/Output Connections

32. Power On/Off
33. VGA 1
34. HDMI
35. VGA 2
36. DVI
37. DisplayPort
38. RJ45 LAN
39. USB Power
40. 3D Sync
41. VGA Out
42. 5BNC
43. RS-232C
44. Wired Remote
45. +12V Trigger (3.5mm)
46. Composite Video
47. S-Video
48. Component Video
49. Master Switch

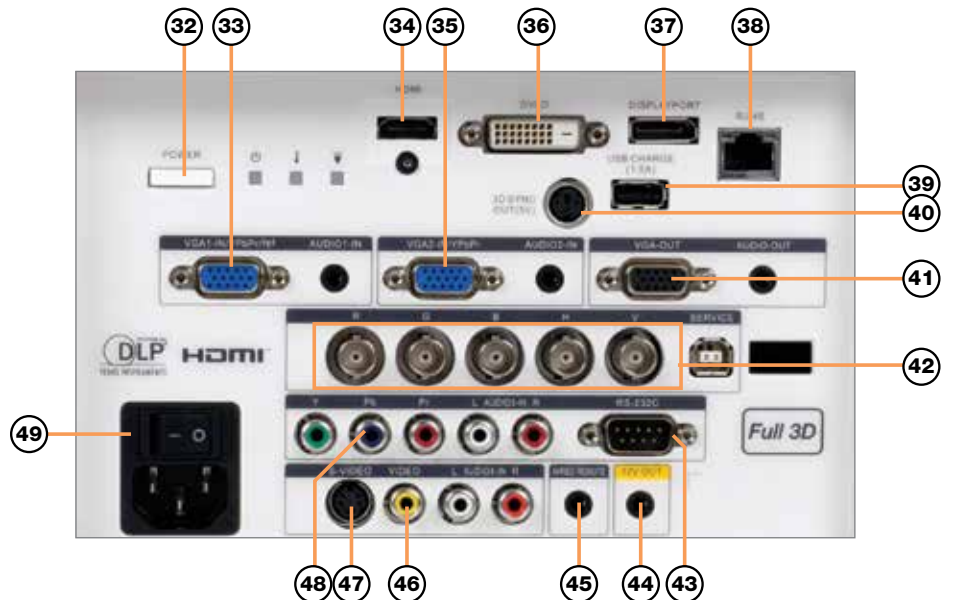

Technical Specifications

Projector		DLPTM Technology by Texas Instruments
	Technology	0.7" XGA, Type A chip
	Resolution Native	XGA (1024 x 768)
	Brightness ¹	6000 ANSI Lumens
	Aspect Ratio	4:3 Native, 16:9 compatible
	Refresh Rate	15kHz to 91kHz / 24Hz to 85Hz (120/144Hz for 3D playback)
	Contrast	2000:1
	2D Video Compatibility	PAL (625/576i/p), SECAM, NTSC (525/480i/p), HDTV (720p, 1080i, 1080p)
	3D Video Compatibility	Mandatory HDMI 1.4 3D formats, 120Hz frame sequential (up to 720p)
Optics		
	Lamp Type	370W UHP
	Lamp Life ²	1500 hr Bright Mode / 3500 hr Eco Mode
	Lens Shift	Manual +60%, -20%V, +/-10%H
	Lenses (no lens supplied as standard)	
	Short	0.8:1
	Semi short	1.14 - 1.35:1
	Standard	1.6 - 2.0:1
	Long	2.0 - 3.0:1
	Extra long	3.11 - 5.18:1
	Keystone Correction	Vertical ±40°
	Uniformity	85% (centre)
Connectivity		
	Inputs	HDMI (with locking Screw) DVI-D (HDCP supported) DisplayPort BNC (RGBHV) PC RGB 2 x 15 pin D-Sub VGA Component 3RCA S-Video/Composite 4 pin Mini DIN / RCA
	Output	PC (monitor loop-through) VGA Out +12V trigger (3.5mm jack) 3D-Sync Out (3-Pin VESA)
	Control and Communication	RS232 9 pin D-SUB RJ45 (Crestron/Extron/PJ-Link/Telnet) Wired Remote (3.5mm jack)
General		
	Noise Level	37dB
	Weight	8.6Kg (without lens)
	Dimensions (W x D x H)	431 x 341 x 183mm
	Power Requirements	100 – 240V AC @ 50 – 60Hz
	Power Consumption	460W (max) bright mode, <0.5w standby mode
	Operating Conditions	5 – 40°C, max. humidity 85%, max. altitude 3000m
	Portrait mode	Not supported
	360° Operation	Not supported
	Operating Temperature	0 ~ 750m, 5 ~ 45°C 750m ~ 1500m, 5 ~ 35°C 1500 ~ 3000m, 5 ~ 30°C
	Environmental	RoHS and WEEE
	Conformances	CE, TUV-GS, CB
	Security	4-digit PIN code Kensington Lock port Security Bar
	Warranties	3 Years
Supplied Accessories		
	Cables	VGA cable AC power cord
	Other	Infra-red remote control (selectable IR code sets for controlling multiple units) Batteries x 2 Quick start card Warranty card WEEE card

Accessories



Universal Ceiling Mounts

Flush Mount

White P/N: OCM818W-RU

Black P/N: OCM818B-RU

The Universal Flush Mount is easy to set up with its unique low-profile design to give you everything you need for quick adjustment and the flexibility to install almost any projector hassle-free.



Pole Mount

White P/N: OCM815W

Black P/N: OCM815B

The Universal Pole Mount is height adjustable from 290mm~810mm. Suitable for virtually any projector under 15Kg. The mount comes pre-assembled with a quick projector disconnect/reconnect for rapid installation, while the 360° rotation and more than +/- 20° tilt/roll provide the flexibility to install almost anywhere. (including vaulted ceilings) Lastly, an integrated cable routing channel ensures a clean, professional finish.



Accessories Continued



Optimised edge blending (Available direct from Optoma)

Optoma have worked in partnership with Calibre to produce special versions of Calibre's ultra low-latency edge blending and warping products optimised for use with our ProScene projectors. This unique collaboration significantly reduces the complexity and configuration time required to edge blend multiple ProScene projectors and is covered by the industry leading ProScene technical support services should you require assistance with your edge blending project.



HQView320 HQV™ Scaler with Warp and Edge Blend

Best in class professional image processing in a compact affordable module.



HQView325 HQV™ Scaler with Warp Mapping Edge Blend & HDMI/DVI In/Out

HQView325 features 4-sided soft edge blend with multi-region black level correction for seamless blending of multiple projectors.



HQView520 Universal HQV™ Scaler-Switcher-Scan Converter with Warp, Edge Blend & 3G-SDI In/Out

Use as a routing switcher and universal interface for 3G-SDI, HD-SDI, DVI or HDMI



HQView530 LCD Screen HQV™ Scaler-Switcher with 3G-SDI

HQView530 is a highly flexible video screen image scaler which provides stunning image quality for professional, broadcast, sports, digital signage & corporate AV.



Offices



Worldwide technical and commercial support

Optoma Europe

Optoma Europe Ltd.

42 Caxton Way
The Watford Business Park
Watford
Hertfordshire
WD18 8QZ
UK
Tel: +44 (0) 1923 691 800
Fax: +44 (0) 1923 691 888

Optoma Deutschland GmbH

WIESENSTRASSE 21
D40549 Düsseldorf
Germany
Tel: +49 (0) 211 506 6670
Fax: +49 (0) 211 506 66799

Optoma France

Batiment E
81-83 avenue Edouard Vaillant
92100 Boulogne Billancourt
France
Tel: +33 (0) 1 41 46 12 20
Fax: +33 (0) 1 41 46 94 35

Optoma Spain

C/ José Hierro,36 Of. 1C
28529 Rivas VaciaMadrid
Madrid
Spain
Tel: +34 91 499 06 06
Fax: +34 91 670 08 32

Optoma Benelux

Optoma Benelux BV
Randstad 22-123
1316 BW Almere
The Netherlands
T: +31 (0) 36 820 0252
F: +31 (0)36 548 9052

Local Representatives

Turkey

UAE

Poland

Russia

Italy

Optoma Scandinavia

Optoma Scandinavia

Lerpeveien 25
Postboks 9515 Åskollen
3038 Drammen
Norway
Tel: +47 32 98 89 90
Fax: +47 32 98 89 99

Optoma USA

Optoma USA Headquarters

3178 Laurelview Ct.
Fremont, CA 94538
Tel: (510) 897-8600
Fax: (510) 897-8601

Atlanta Sales Office

7000 Central Park NE, Suite 570,
Atlanta, GA 30328
Tel: (678) 281-2228
Fax: (770) 399-3035

Canadian Sales Office

2420 Meadowpine Blvd, Suite 105,
Mississauga, ON L5N 6S2, CANADA
Tel: (905) 285-0685

Optoma Asia

Taiwan

Optoma Corporation
Taipei Office
5F., No. 108, Minchiuan Rd., Shindian City,
Taipei Taiwan 231, R.O.C.
Tel: +886-2-2218-2360
Fax: +886-2-2218-2313
<http://www.optoma.com.tw>

Taichung Office

7F-5, No.3, Lane 2, 1st Rd, Taichung Industrial
Park, Xitun Dist., Taichung City, 40767, Taiwan,
R.O.C.
Tel: +886-4-3505-0336
Fax: +886-4-3505-0338

Kaohsiung Office

Rm. D, 7F, No.108, Zhonghua 3rd Rd., Qianjin
Dist., Kaohsiung City 80145, Taiwan, R.O.C.
Tel: +886-7-952-5689
Fax: +886-7-241-2197

China

Shanghai Office
5F, No. 1205 Kaixuan Road, Changning
District, Shanghai
Tel: +86-21-6294-7376
Fax: +86-21-6294-7375
<http://www.optoma.com.cn>

Beijing Office

20D apartment 3, Build No.3, Yindu Tower, No
48 ZhiChun road, HaiDian district, Beijing
Tel: +86-10-5873-1919
Fax: +86-10-5873-1919 *8018

ShenYang Office

Room1201, building C3, Wulihe Tower, No 4-1
WenTi road, HePing district, ShenYang
Tel: +86-024-3188-7018
Fax: +86-024-3188-7018-808

Xi'an Office

Room 1310, building B, ShiMao tower,
GuanDongZheng street, Xi'an
Tel: +86-029-8228-2428
Fax: +86-029-8228-2428

GungZhou Office

Room 602, NanTie Tower, No.57
No.1ZhongShan road, YueXiu district,
GungZhou
Tel: +86-20-6128-0990 / 6128-1025
Fax: +86-20-6128-1027

ChongQing Office

Room 9-2, building 19 HuaYuMingDu,
ShiQiaoPu, ChongQing
Tel: +86-23-6879-7626
Fax: +86-23-6879-7725

ChengDu Office

Room A3 floor 20, building A Time digital
square, No.1 South RenMin road, ChengDu
Tel: +86-28-8523-1553 / 8631-7092

Hong Kong Office

Unit A, 27/F., Dragon Centre, 79 Wing Hong
Street, Cheung Sha Wan, Kowloon, Hong Kong
Tel: +852-2396-8968
Fax: +852-2370-1222
<http://www.optoma.com.hk>



Optoma Europe Ltd.

42 Caxton Way, Watford Business Park, Watford, Hertfordshire, UK. WD18 8QZ

www.optoma.com



¹Brightness and lamp lifetime will vary depending on selected projector mode, environmental conditions and usage. As is common with all lamp based projectors, brightness will decrease over the lamp lifetime. ²Typical lamp life achieved through testing. Will vary according to operational use and environmental conditions. Optoma guarantees that in normal use, Optoma DLP[®] colour quality will be indistinguishable from when new. Exclusions: (a) Guarantee is voided if the projector is subject to damage through misuse. (b) Guarantee may be void in industrial or commercial entertainment environments where dust or smoke is excessive (c) Guarantee will not apply if lamp brightness is below 50% due to wear or if the projector is not working due to other faults. (d) Over time worn lamps within all projector types will show a slight colour variance. Copyright © 2014, Optoma Europe Ltd. All other product names and company names used herein are for identification purposes only and may be trademarks or registered trademarks of their respective owners. Crestron[®], the Crestron and RoomView[®] logo are registered trademarks of Crestron Electronics, Inc. Errors and omissions excepted, all specifications are subject to change without notice. DLP[®], BrilliantColor[™] and the DLP logo are registered trademarks of Texas Instruments. All images of products are for representation purposes only. Whilst every care is taken to provide accurate images of our products, actual products may differ slightly. Some product images may have been digitally altered by us to add an Optoma logo to the front panel. Optoma reserves the right to amend or alter actual product or product images without notice. Some images may be simulated.