



Product Description

Conceived, engineered and built with precision in the United Kingdom, VX Series represents the latest evolution of Tannoy's core philosophies in professional loudspeaker design. VX 12 builds on the foundation of the highly successful and ubiquitous V12, justly renowned worldwide for its exceptional performance and versatility. Now incorporating significant upgrades, the successor VX 12 offers a compact yet punchy and sonically vibrant solution for medium-scale live reinforcement as well as for demanding BGM systems in – for example – fashion retail outlets, bars, and small clubs. The VX 12 has been sonically matched with the wider range of VXP Series models, this allows consistency in an installations where there is a mix of products utilised

The VX 12 is built around a single 305 mm (12") Dual Concentric™ driver mounted within a compact, rugged birch plywood cabinet with aesthetically profiled edges and an Airnet™-backed, powder-coated steel grille. The latest high power-handling version of Tannoy's exclusive point source, constant directivity Dual Concentric technology ensures high power output with high sensitivity and exceptional efficiency. More than 60 years of research into Dual Concentric technology allows this unique configuration to deliver exceptionally smooth beam-width characteristics resulting in an even coverage pattern at all frequencies aiding predictable system design. Symmetrical dispersion characteristics enhance speaker placement flexibility, allowing vertical or horizontal mounting of single or multi-cabinet arrays without any compromise in sound quality.

Audio connection is via barrier strip or NL 4MP speakON located on the flush-mounted termination panel. An extensive range of high performance steel mounting hardware, custom designed for VX 12, includes a yoke bracket for wall and ceiling location, eyebolt location points, and a VTH top-hat for pole-mounting. For absolute security and installers' peace of mind, all hardware has been tested and certified to guarantee greater than 5:1 safety ratio.

The VX 12 is available in black or white textured paint finish as standard (with matching grilles), and is also available in custom matched RAL colours as an option. The optional weather protected specification (WP) includes LINE-X cabinet outer-coating, internal sealing, and treated transducers with perforated Grade 316 stainless steel grilles. All steel hardware is upgraded to Grade 304 stainless steel, while all connector panel points are protected by a cover plate and weather-proof cable gland. Additional ordering lead time applies to all non-standard specifications.

Features

- 305 mm (12") Dual Concentric full-range driver
- Well defined 90 degree dispersion for optimum coverage and forward gain
- Peak output 126 dB SPL @ 1 m, recommended amp power 400 W @ 8 ohms
- Versatile mounting via optional custom designed hardware
- Integrip™ handles ergonomically integrated into cabinet
- Pole-mountable for optimum portability
- Exceptional sound and performance in a highly compact cabinet
- Rugged birch plywood enclosure
- Available in black or white textured paint finish – custom colours optional
- Available in weather protected specification (optional)
- Engineered and built in UK

Applications

- Theatres, Auditoria and Houses of Worship
- Medium scale PA.
- Bars and nightclubs
- Portable and installed corporate AV
- Theme parks and leisure venues
- Gymnasiums and small/medium sports arenas
- Cinemas

Tannoy (Direct UK)
TCGI (ROW sales)
TCGA (Americas sales)
Tannoy Middle East

T: +44 (0) 1236 420199
T: +45 8742 7000
T: +1 (519) 745 1158
T: +971 (04) 4401208

E: enquiries@tannoy.com
E: info@tcgroup-international.com
E: info@tcgroup-americas.com
E: enquiries@tannoy.com

tannoy®.com



VX 12

TANNOY®

TECHNICAL SPECIFICATIONS

System	VX 12	
Frequency Response (-3 dB) ⁽¹⁾	70 Hz - 25 kHz	
Frequency Range (-10 dB) ⁽¹⁾	55 Hz - 38 kHz	
System Sensitivity (1 W @ 1 m) ⁽²⁾	97 dB (1 W = 2.83 V for 8 ohms)	
Dispersion (-6 dB)	90 degrees conical	
Driver Complement	1 x 305 mm (12") constant directivity Dual Concentric	
Crossover	Passive 1 kHz with HF protection	
Directivity Factor (Q)	9.6 (averaged 1 kHz to 8 kHz)	
Directivity Index (DI)	9.8 dB (averaged 1 kHz to 8 kHz)	
Rated Maximum SPL ⁽²⁾	120 dB (average) 126 dB (peak)	
Power Handling		
Average	200 W	
Programme	400 W	
Peak	800 W	
Recommended Amplifier Power	400 W @ 8 ohms	
Nominal Impedance	8 ohms	
Distortion		
10% Full Power (12.65 V)	2nd Harmonic	3rd Harmonic
250 Hz	0.52%	0.58%
1 kHz	2.98%	0.63%
10 kHz	3.58%	0.19%
1% Full Power (4 V)	2nd Harmonic	3rd Harmonic
250 Hz	0.10%	0.26%
1 kHz	0.81%	0.58%
10 kHz	1.18%	0.03%

Construction

Enclosure	36.4 litre, 15 mm (enclosure) and 18 mm (front) birch plywood, vented and internally braced.
Finish	Textured black or white paint, with custom colours on request. Powder-coated perforated steel grille, Airnet cloth behind.
Connectors	2 x speakON NL 4MP and Barrier strip
Fittings	8 x M10 Flying inserts (portrait or landscape mounting), 8 x M10 yoke bracket inserts, 2 x Integrip carrying handles, Blanking plate for optional VTH pole mount, Fixings compatible with Powerdrive™ style brackets, 4 x M6 inserts
Dimensions (HxWxD)	486 x 370 x 360 mm (19.1 x 14.6 x 14.1")
Net weight	17 kg (37.5 lbs)
Shipped weight	19.5 kg (43 lbs)
Packed quantity	1

Notes

(1) Average over stated bandwidth. Measured at 1 metre on axis in an anechoic chamber

(2) Unweighted pink noise input, measured at 1 metre in an anechoic chamber. A full range of measurements, performance data, and Ease™ Data can be downloaded at www.tannoy.com.

Tannoy is committed to a policy of continuous improvement through research and development. Though performance will equal or exceed published specifications, new materials or manufacturing processes could introduce variances. All figures are subject to change without notice. For critical applications, please confirm current specifications with your supplier or visit the Tannoy website at www.tannoy.com.

Ordering Information

PART NUMBER	MODEL NAME	COLOUR	PACKED QUANTITY
8001 6350	VX 12	BLACK	1
8001 6351	VX 12	WHITE	1

Tannoy (Direct UK)
TCGI (ROW sales)
TCGA (Americas sales)
Tannoy Middle East

T: +44 (0) 1236 420199
T: +45 8742 7000
T: +1 (519) 745 1158
T: +971 (04) 4401208

E: enquiries@tannoy.com
E: info@tcgroup-international.com
E: info@tcgroup-americas.com
E: enquiries@tannoy.com

tannoy.com



PERFORMANCE MEASUREMENTS

1 m on-axis Frequency Response

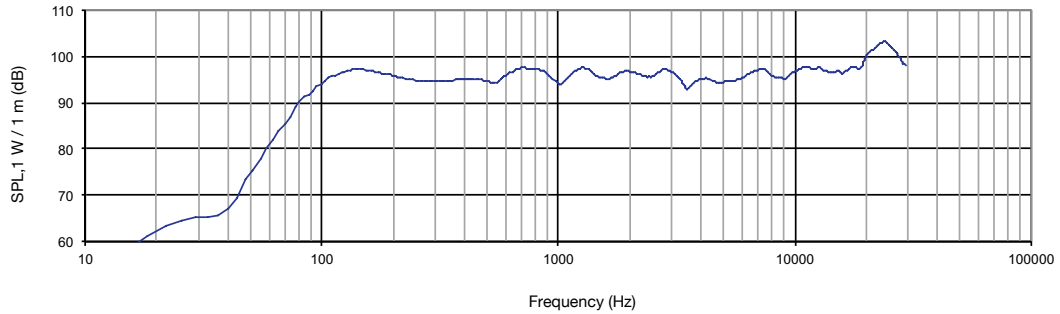

ANECHOIC FREQUENCY RESPONSE

Impedance vs frequency

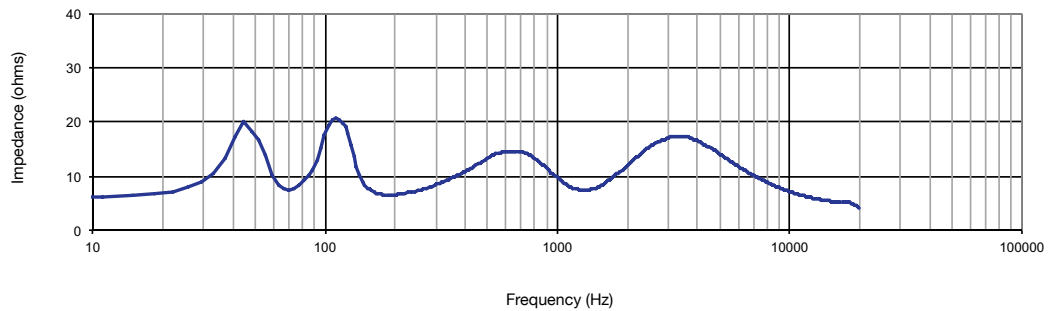

IMPEDANCE

Off-axis Frequency Response

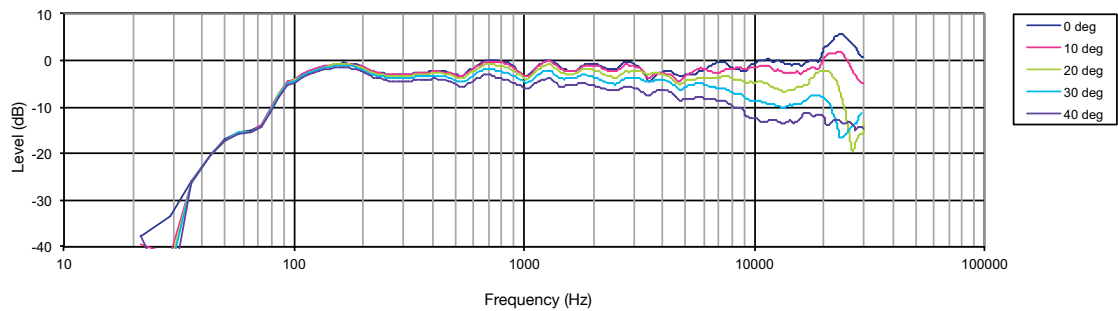

OFF-AXIS RESPONSE

Tannoy (Direct UK)
 TCGI (ROW sales)
 TCGA (Americas sales)
 Tannoy Middle East

T: +44 (0) 1236 420199
 T: +45 8742 7000
 T: +1 (519) 745 1158
 T: +971 (04) 4401208

E: enquiries@tannoy.com
 E: info@tcgroup-international.com
 E: info@tcgroup-americas.com
 E: enquiries@tannoy.com

tannoy.com



PERFORMANCE MEASUREMENTS

Beamwidth vs Frequency

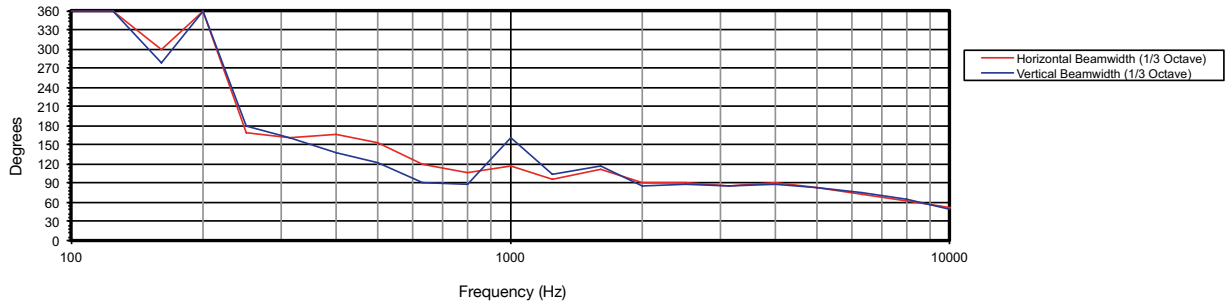

BEAMWIDTH

DI vs Frequency

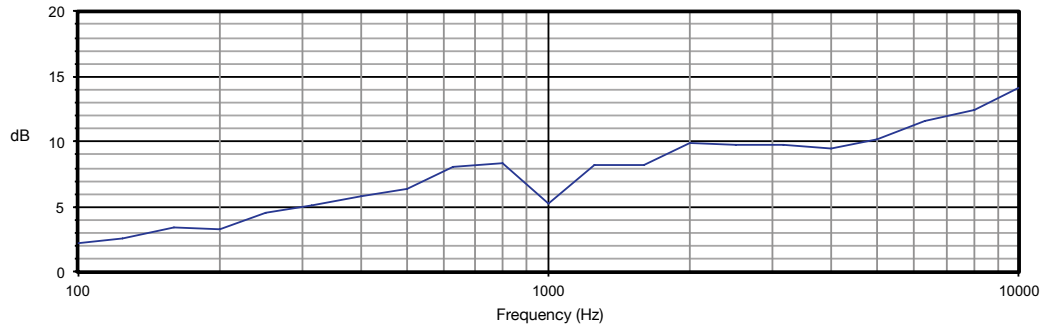

DIRECTIVITY INDEX (DI)

Tannoy (Direct UK)
 TCGI (ROW sales)
 TCGA (Americas sales)
 Tannoy Middle East

T: +44 (0) 1236 420199
 T: +45 8742 7000
 T: +1 (519) 745 1158
 T: +971 (04) 4401208

E: enquiries@tannoy.com
 E: info@tcgroup-international.com
 E: info@tcgroup-americas.com
 E: enquiries@tannoy.com

tannoy®.com



PERFORMANCE MEASUREMENTS POLAR PLOTS (1/3 OCTAVE)

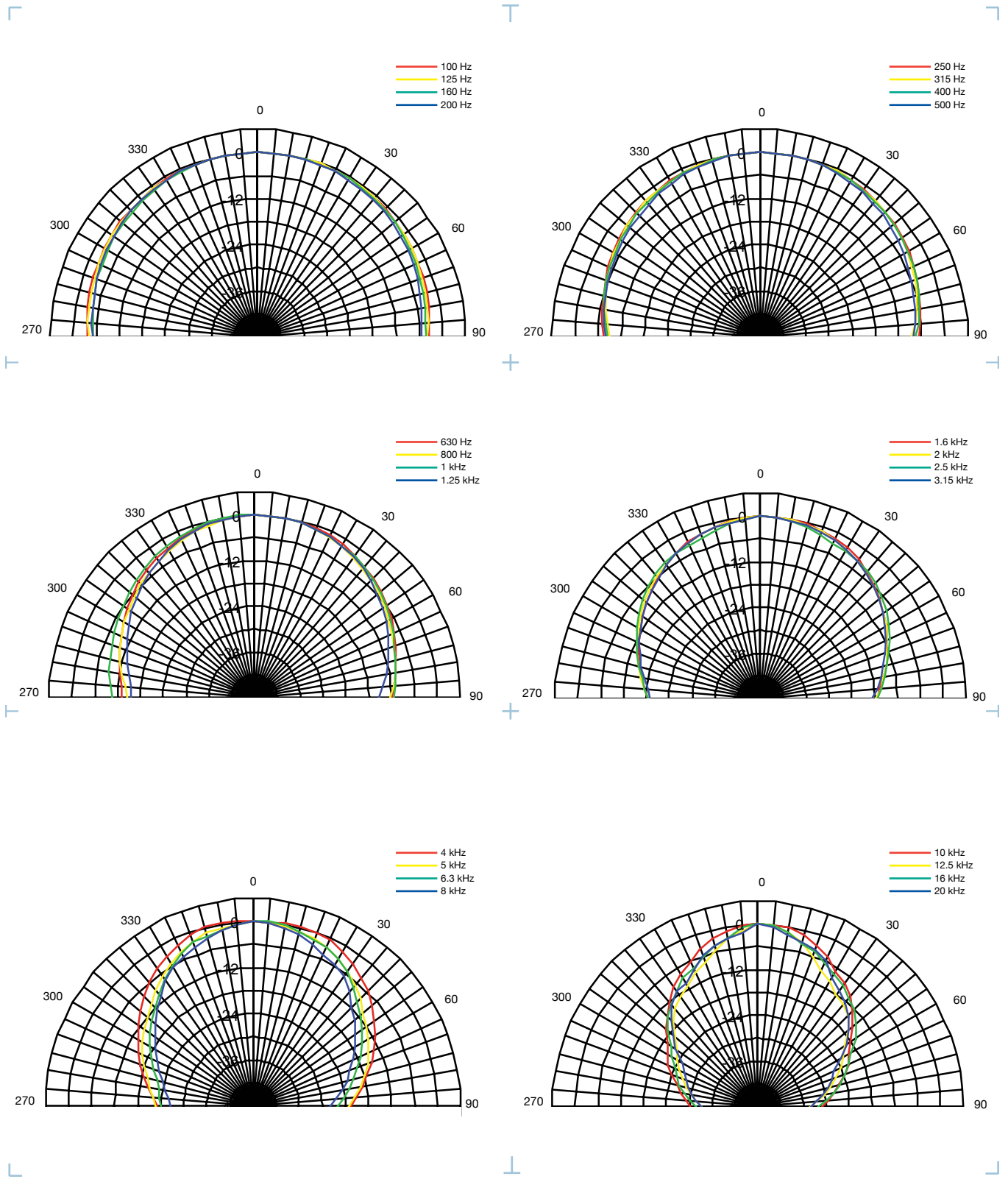

Tannoy (Direct UK)
 TCGI (ROW sales)
 TCGA (Americas sales)
 Tannoy Middle East

T: +44 (0) 1236 420199
 T: +45 8742 7000
 T: +1 (519) 745 1158
 T: +971 (04) 4401208

E: enquiries@tannoy.com
 E: info@tcgroup-international.com
 E: info@tcgroup-americas.com
 E: enquiries@tannoy.com

tannoy®.com



PERFORMANCE MEASUREMENTS POLAR PLOTS (1/3 OCTAVE)

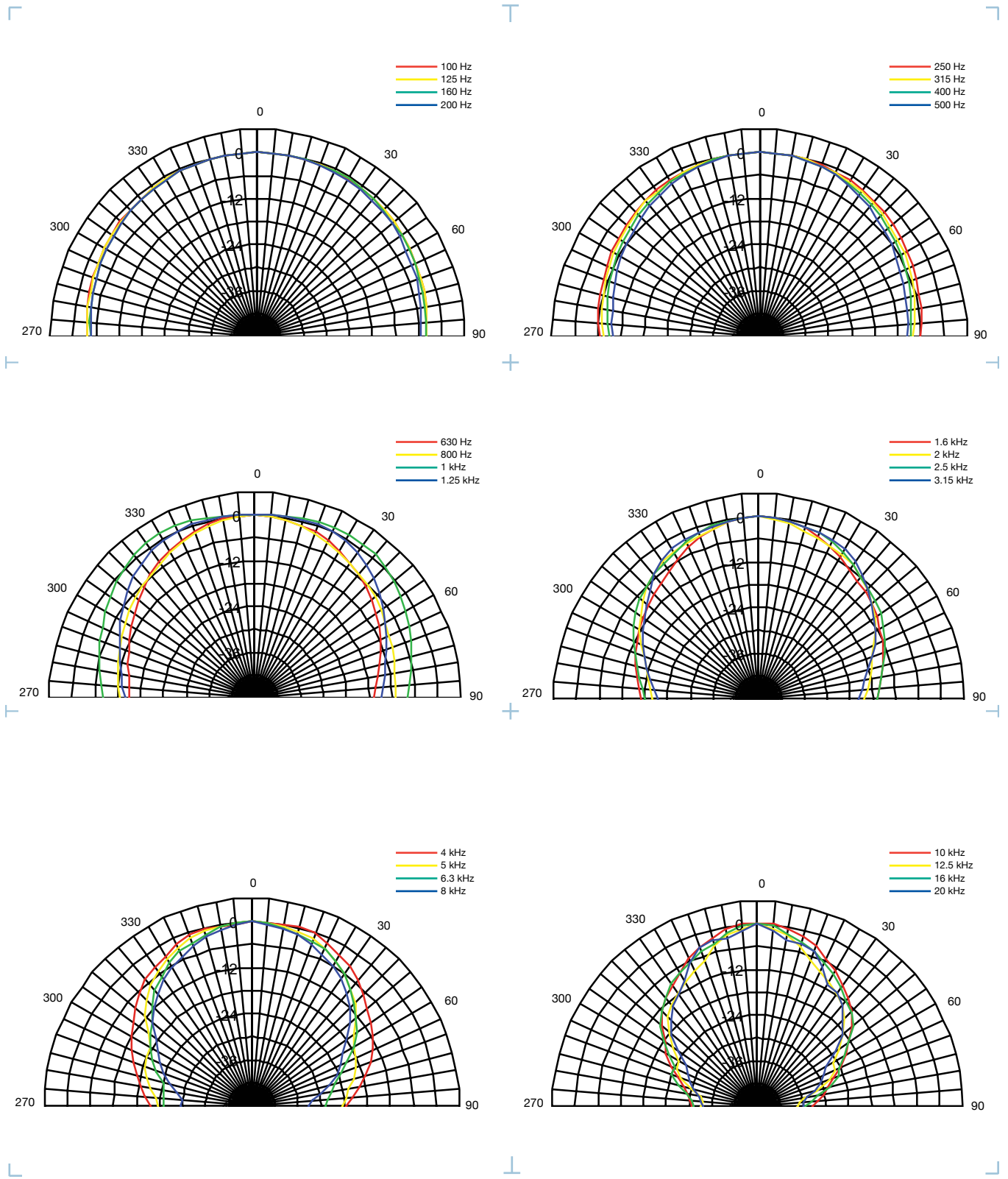

Tannoy (Direct UK)
 TCGI (ROW sales)
 TCGA (Americas sales)
 Tannoy Middle East

T: +44 (0) 1236 420199
 T: +45 8742 7000
 T: +1 (519) 745 1158
 T: +971 (04) 4401208

E: enquiries@tannoy.com
 E: info@tcgroup-international.com
 E: info@tcgroup-americas.com
 E: enquiries@tannoy.com

tannoy®.com



VX 12

TANNOY®

DIMENSIONAL SKETCHES

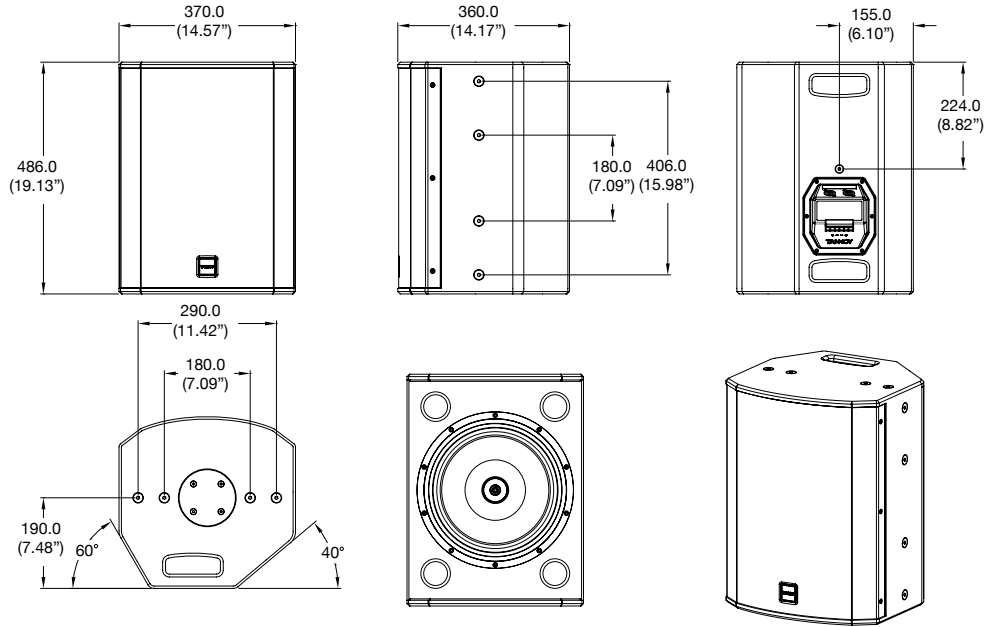

Tannoy (Direct UK)
 TCGI (ROW sales)
 TCGA (Americas sales)
 Tannoy Middle East

T: +44 (0) 1236 420199
 T: +45 8742 7000
 T: +1 (519) 745 1158
 T: +971 (04) 4401208

E: enquiries@tannoy.com
 E: info@tcgroup-international.com
 E: info@tcgroup-americas.com
 E: enquiries@tannoy.com

tannoy®.com



Architectural specifications

The loudspeaker shall consist of a 305 mm (12") full range, single point source Dual Concentric transducer. The low and the high frequency elements shall be combined by an internal passive crossover network operating at 1 kHz.

Performance of the loudspeaker, without any external electronic control, shall meet or exceed the following criteria: Frequency response measured at 1 metre on axis with swept sine wave shall be 70 Hz – 25 kHz (-3d B). Sensitivity shall be at least 97 dB (anechoic) 1 watt @ 1 metre and the loudspeaker shall be capable of producing a peak output level of 126 dB (anechoic) on axis at 1 metre. Dispersion shall be 90 degrees conical (-6 dB). The system shall have a nominal impedance of 8 ohms. Long-term power handling (EIA-426B) shall be 200 watts and recommended amplifier power shall be 400 watts.

The enclosure shall be an optimally tuned 36.4 litre vented enclosure of birch plywood construction. The enclosure shall be fitted with an integral carrying handle, blanked off recess for optional pole-mount socket installation, 8 x M10 yoke bracket inserts, and 8 x M10 mounting points for flying hardware. The enclosure shall not exceed the following dimensions: 486 x 370 x 360 mm or 19.1 x 14.6 x 14.1" (H x W x D). The loudspeaker shall be the Tannoy VX 12.