

GEWISS

Serie 90

RESTART / AUTOTEST

RESTART
Autotest



GW 90 901 - GW 90 902

AVVERTENZE PER LA SICUREZZA

N.B. Leggere attentamente prima dell'installazione e dell'utilizzo del dispositivo

- **Non intervenire mai sull'impianto con il dispositivo inserito.**
- Non accedere ai collegamenti elettrici senza aver tolto tensione all'impianto.
- Il prodotto non è idoneo all'installazione in reti fase-fase.
- Quando il dispositivo è in modalità manuale, svolge la funzione di protezione di un interruttore differenziale tradizionale.
- Quando il dispositivo è in modalità automatica svolge un controllo periodico di funzionalità e svolge un controllo dell'impianto, in seguito ad apertura dell'interruttore differenziale, per verificare la possibilità di ripristino automatico in sicurezza.
- Eventuali posizioni intermedie della leva non costituiscono malfunzionamenti se temporanee.
- Se occorre disalimentare manualmente l'impianto entro 3 minuti da un precedente riarmo automatico agire sul pulsante di test dell'interruttore differenziale previa apertura dello sportello (o sugli interruttori collegati a valle).
- Scatti della leva e rumori durante il ciclo di autodiagnosi sono del tutto normali.

INDICE

• Funzioni di prodotto	4
- Funzione di autodiagnosi	4
- Funzione di riarmo	5
• Descrizioni del dispositivo RESTART con AUTOTEST	6
- Funzionamento automatico	6
- Funzioni di autodiagnosi e riarmo attive	6
- Funzionamento manuale	7
- Funzioni di autodiagnosi e riarmo non attive	7
• Istruzioni per l'uso	8
- Funzionamento automatico	8
- Inserimento modalità automatica	8
- Riarmo automatico	8
- Test automatico	10
- Sincronizzazione	10
- Funzionamento manuale	11
- Da automatico a manuale	11
- Test mensile del differenziale	11
• Segnalazione dei led	12
• Istruzioni per l'installazione	14
- Installazione	14
- Collegamento	14
- Test di verifica	14
- Configurazione del contatto ausiliario	15
• Caratteristiche tecniche	16
• Dimensioni	16

FUNZIONI DI PRODOTTO

FUNZIONE DI AUTODIAGNOSI

RESTART / AUTOTEST è un dispositivo che incorpora la possibilità di effettuare una autodiagnosi settimanale sia elettrica che meccanica, senza interruzione dell'alimentazione dell'impianto ad esso collegato.

Se durante la modalità di test vengono rilevate delle anomalie, viene segnalata la condizione di possibile guasto.

Il dispositivo è dotato di protezione differenziale aggiuntiva in grado di rilevare, a seguito di una dispersione nell'impianto, il mancato sgancio dell'interruttore differenziale.

La funzione di autodiagnosi consiste nel far compiere ogni settimana una manovra di sgancio dell'interruttore differenziale simulando la pressione manuale del tasto di test.

Il test si compone delle seguenti fasi della durata di circa 2 minuti complessivi:

- Chiusura di un circuito di by-pass in parallelo ai contatti di potenza dell'interruttore differenziale
- Iniezione di una corrente di fuga a terra pari alla corrente nominale I_{dn} per procurare l'apertura dell'interruttore differenziale
- Test elettronico dello stato di tutte le parti meccaniche ed elettriche del dispositivo
- Richiusura dei contatti di potenza dell'interruttore differenziale tramite riarmo della leva
- Riapertura del circuito di by-pass e ritorno allo stato iniziale di normale funzionamento.

È possibile stabilire l'orario di esecuzione del test periodico tramite la funzione di sincronizzazione. Durante tutte le fasi del test è comunque presente la protezione differenziale.

FUNZIONE DI RIARMO

La funzione di riarmo consiste nella richiusura automatica dell'interruttore differenziale in caso di sgancio intempestivo per fenomeno elettrico temporaneo (fulmini, perturbazioni, ecc.)

Prima di procedere all'azione di richiusura il dispositivo effettua un controllo di assenza di guasto a terra sul circuito a valle: se viene rilevato un guasto si porta in stato di blocco altrimenti procede alla richiusura.

Dopo un terzo intervento dell'interruttore differenziale entro tre minuti da un precedente riarmo automatico, il dispositivo si porta in stato di blocco.

Per riabilitare la funzione di riarmo, aprire lo sportello, alzare la leva dell'interruttore differenziale in posizione " I " e chiudere lo sportello.

Se l'interruttore differenziale non rimane in posizione " I ", sospendere i tentativi e chiamare un tecnico specializzato per verificare l'impianto.

Non è possibile attivare la funzione di riarmo ad interruttore differenziale aperto. Per attivarla è necessario alzare la leva dell'interruttore differenziale in posizione " I " e chiudere lo sportello. A funzioni attivate il tasto di test e la leva dell'interruttore differenziale non sono accessibili.

DESCRIZIONI DEL DISPOSITIVO RESTART CON AUTOTEST

FUNZIONAMENTO AUTOMATICO

FUNZIONI DI AUTODIAGNOSI E RIARMO ATTIVE

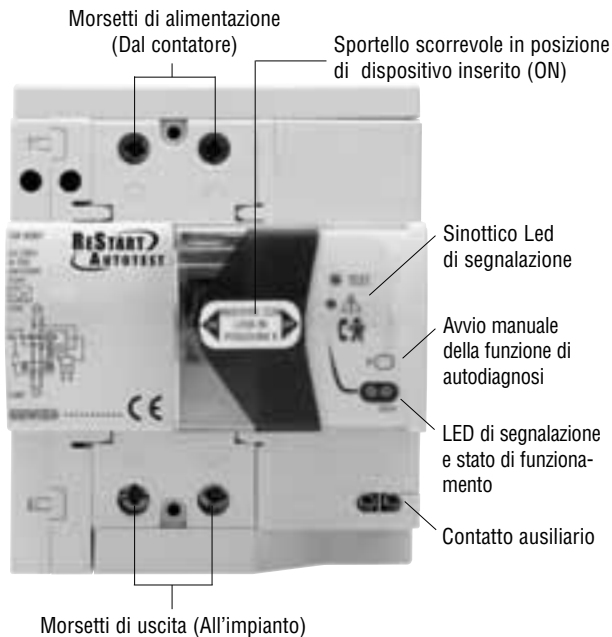

FUNZIONAMENTO MANUALE

FUNZIONI DI AUTODIAGNOSI E RIARMO NON ATTIVE



ISTRUZIONI PER L'USO

FUNZIONAMENTO AUTOMATICO

INSERIMENTO MODALITÀ AUTOMATICA

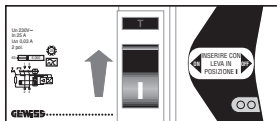

Alzare la leva.
(Impianto sotto tensione).

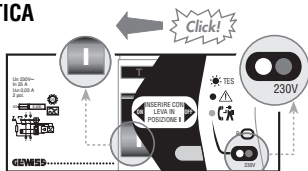

Far scorrere lo sportello fino a sentire lo scatto (impianto sotto tensione). Attivazione confermata da accensione led verde.

RIARMO AUTOMATICO:

- In caso di guasto temporaneo

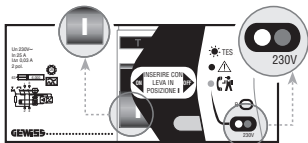

1. Funzionamento normale.

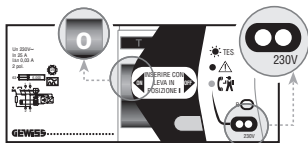

2. Scatto dell'interruttore differenziale (la leva si abbassa togliendo tensione).

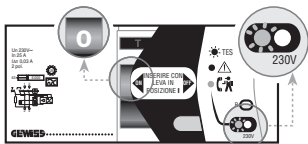

3. L'apparecchio esegue un test dell'impianto di circa 60sec. (Spia rossa lampeggiante). *

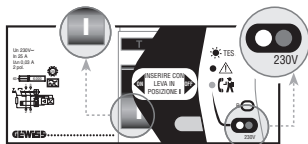

4. Riarmo eseguito (la leva si rialza ridando tensione all'impianto, e nei 3 minuti successivi non è azionabile manualmente).

* È possibile forzare manualmente la chiusura dell'interruttore differenziale passando in modalità manuale ed alzando la leva. Nel caso l'interruttore differenziale scatti nuovamente chiamare l'installatore.

- In caso di guasto permanente

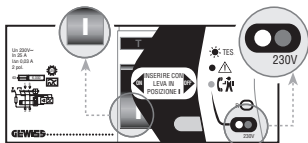

1. Funzionamento normale.

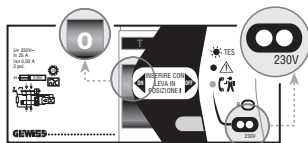

2. Scatto dell'interruttore differenziale (la leva si abbassa togliendo tensione).

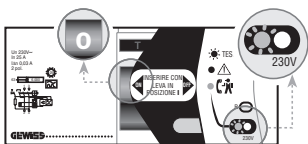

3. L'apparecchio esegue un test dell'impianto di almeno 20sec. (Spia rossa lampeggiante).*

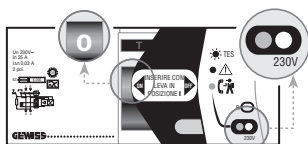

4. Riarmo non eseguito per problemi all'impianto. (Impianto non in tensione).

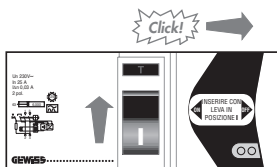

5. Procedere ad un tentativo di riarmo manuale aprendo lo sportello ed alzando la leva. In caso di mancata riattivazione desistere dal continuare l'operazione di riarmo e contattare un tecnico specializzato.

ISTRUZIONI PER L'USO

TEST AUTOMATICO

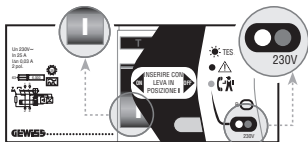

1. Funzionamento normale.

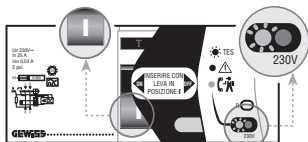

2. Inizio test

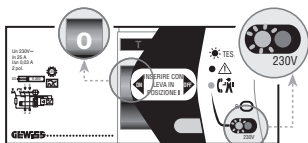

3. Scatto automatico leva interruttore (mantenendo tensione all'impianto).

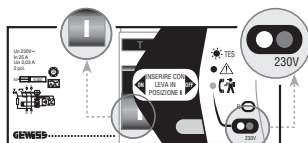

4. Riarmo eseguito. (Nei 3 minuti successivi la leva non è azionabile manualmente).

SINCRONIZZAZIONE

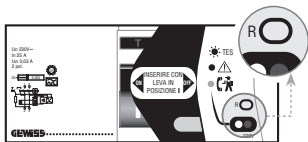

È possibile in qualsiasi momento forzare l'autodiagnosi premendo il tasto R con una punta sottile (utensile, penna, ..) Il programma settimanale di autodiagnosi verrà sincronizzato ed il conteggio dei 7 giorni ripartirà da questo momento.

È possibile riscontrare qualche minuto di ritardo nell'esecuzione del ciclo di autotest se il tasto R viene premuto a seguito di un precedente riarmo.

FUNZIONAMENTO MANUALE

DA AUTOMATICO A MANUALE



Far scorrere lo sportello fino a sentire lo scatto. (Impianto sotto tensione).

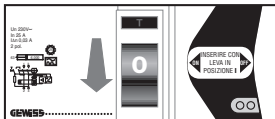

Nel caso si desideri togliere tensione all'impianto abbassare la leva.





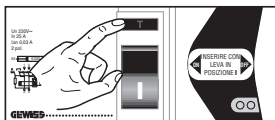



Con il dispositivo in funzionamento manuale non vengono eseguite automaticamente le funzioni di riarmo e autodiagnosi.

TEST MENSILE DEL DIFFERENZIALE



















Nel caso di un utilizzo prolungato in modalità manuale premere il tasto di test ogni mese. Se la leva non scatta chiamare un tecnico per la verifica dell'apparecchio.

SEGNALAZIONE DEI LED

LED SX	LED DX	FRONTALE DISPOSITIVO	CONDIZIONE	CONTATTO AUSILIARIO
Funzionamento manuale				
○	○		Dispositivo di riarmo e autodiagnosi non inserito. Interruttore differenziale chiuso. Impianto alimentato.	
○	○		Dispositivo di riarmo e autodiagnosi non inserito. Interruttore differenziale scattato o aperto intenzionalmente. Impianto non alimentato.	
● giallo	○		Dispositivo di riarmo e autodiagnosi guasto . Chiamare un tecnico per la sostituzione immediata del prodotto. Impianto non alimentato.*	
● giallo	○		Dispositivo di riarmo e autodiagnosi guasto . Chiamare un tecnico per la sostituzione immediata del prodotto. Impianto alimentato.	

* Prima di contattare un tecnico specializzato tentare una sola richiusura manuale.

LED SX	LED DX	FRONTALE DISPOSITIVO	CONDIZIONE	CONTATTO AUSILIARIO
Funzionamento automatico				
	verde		Dispositivo di riarmo e autodiagnosi inserito. Interruttore differenziale chiuso. Impianto alimentato.	
	verde		Autodiagnosi in corso. Attendere circa 60 secondi. Impianto alimentato tramite by-pass.	
rosso			Dispositivo di riarmo e autodiagnosi in blocco per guasto dell'impianto a valle. Interruttore differenziale aperto. Impianto non alimentato. *	
rosso			Dispositivo di riarmo e autodiagnosi in fase di verifica presenza guasto o richiusura . L'apertura dello sportello interrompe la richiusura automatica rendendo possibile la manovra manuale. Impianto non alimentato.	
giallo			Dispositivo di riarmo e autodiagnosi guasto . Chiamare un tecnico per la sostituzione immediata del prodotto. Interruttore differenziale aperto. Impianto non alimentato. *	
giallo	verde		Dispositivo di riarmo e autodiagnosi guasto . Chiamare un tecnico per la sostituzione immediata del prodotto. Impianto alimentato.	

* Prima di contattare un tecnico specializzato tentare una sola richiusura manuale.

Legenda



Led spento



Led acceso



Led lampeggiante



Contatto aperto



Contatto attivo

ISTRUZIONI PER L'INSTALLAZIONE

INSTALLAZIONE

L'installazione del dispositivo è del tutto identica a quella di un normale interruttore differenziale.

Prima di collegare l'interruttore accertarsi che non vi sia tensione nell'impianto.

Collegare l'interruttore come indicato nella figura prestando attenzione all'alimentazione che deve essere assolutamente eseguita dall'alto.

COLLEGAMENTO

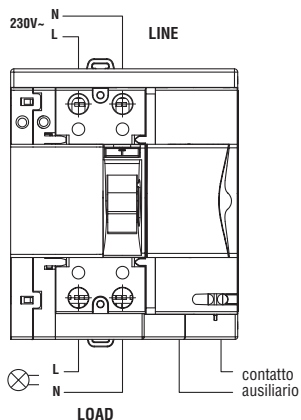

TEST DI VERIFICA

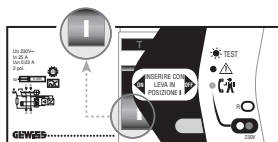

Alla prima messa in servizio, far scattare l'interruttore differenziale con le apposite strumentazioni di verifica impianto ed il dispositivo in funzionamento automatico.

Nel caso il ciclo di riarmo non venga concluso correttamente verificare l'isolamento verso terra dell'impianto, che deve superare i 500k Ω .

Effettuato il collegamento alla rete, procedere con l'attivazione, test di verifica e la sincronizzazione.

CONFIGURAZIONE DEL CONTATTO AUSILIARIO

È possibile configurare il contatto ausiliario per diversi usi semplicemente con la pressione prolungata per 5" del tasto R. Il passaggio tra le diverse modalità è confermato con lampeggi rossi del led di sinistra.

- **Stato 1 (default): funzionamento con suoneria.**

Al blocco il contatto NA commuta in intermittente con frequenza 1 Hz per 30 secondi e ripete la sequenza ogni ora.

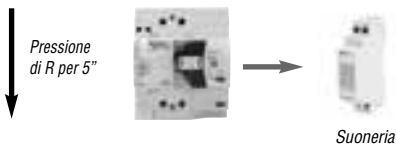

- **Stato 2: funzionamento con combinatore telefonico o spia luminosa.**

Attivazione confermata da 2 lampeggi. Al blocco il contatto NA commuta e rimane chiuso fino all'apertura dello sportello.

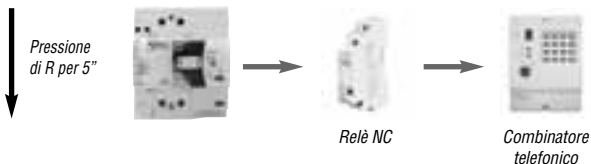

- **Stato 3: comunicazione con il centralino ACTIVO.**

Attivazione confermata da 3 lampeggi. (Per gli schemi di cablaggio riferirsi al manuale del centralino ACTIVO).

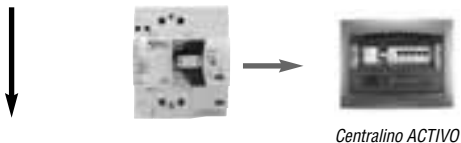

Per tornare allo **Stato 1** premere R per 5". Attivazione confermata dal lampeggio.

CARATTERISTICHE TECNICHE

Tensione nominale Vn: 230Vac fase/neutro TT e TN

Tensione di funzionamento: da 0.85 a 1.1 Vn

Potenza assorbita a riposo: 8 VA

Potenza assorbita in stato di blocco: 8 VA

Corrente nominale: - 25A GW 90 901

- 40A GW 90 902

Durata massima del test: 2 minuti

Tensione di isolamento verso massa: 2500V

Sensibilità interruttore differenziale puro: 30 mA

Tipo: A

N. moduli DIN: 5

Numero Poli: 2

Temperatura d'impiego: da -5°C a +40°C

63  6000

Contatto ausiliario

- Tensione nominale: 230Vac
- Corrente max: 50mA $\cos \varphi = 1$
- Corrente min.: 0.6mA
- Sezione morsetti: $\leq 2,5\text{mm}^2$

DIMENSIONI

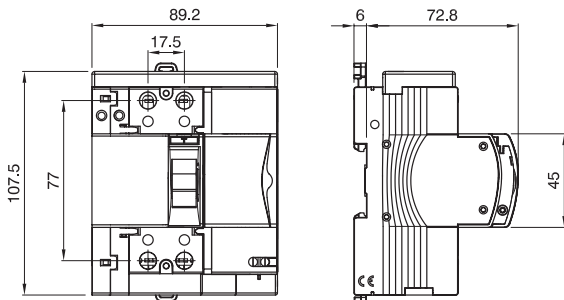

GEWISS

E N G L I S H

RESTART / AUTOTEST

Series 90

SAFETY WARNINGS

N.B. Read carefully before installing and using the device

- **Never work on the system with the device cut in.**
- Do not access the electrical connections without having powered down the system.
- The product is not suitable for installation in phase-to-phase networks.
- When the device is in manual mode it carries out the protection function of a traditional differential switch.
- When the device is in automatic mode it makes a periodic function check and makes a check of the system, following the opening of the differential switch, to verify the possibility of restarting automatically in safety.
- Possible intermediate positions of the lever are not malfunctions if they are temporary.
- If the system is to be powered down manually within 3 minutes of a previous automatic restart, use the test button of the differential switch after opening the hatch (or use the switches connected downstream).
- It is quite normal for the lever to click and to hear noises during the self-diagnosis cycle

INDEX

• Product functions	20
- Self-diagnosis function	20
- The restart function.....	21
• Description of the RESTART with AUTOTEST device	22
- Automatic operation	22
- Self-diagnosis and restart functions active	22
- Manual operation	23
- Self-diagnosis and restart functions not active	23
• User instructions	24
- Automatic operation	24
- Cutting in automatic mode	24
- Automatic restart	24
- Automatic test	26
- Synchronisation	26
- Manual operation	27
- From automatic to manual	27
- Monthly test of the differential	27
• Led signals	28
• Installation instructions	30
- Installation	30
- Connection	30
- Verification test.....	30
- Auxiliary contact configuration	31
• Technical data	32
• Dimensions	32

PRODUCT FUNCTIONS

SELF-DIAGNOSIS FUNCTION

RESTART / AUTOTEST is a device incorporating the possibility of making a weekly self-diagnosis, both electrical and mechanical, without interrupting the power supply of the system connected to it.

A possible fault condition is signalled if anomalies are detected when in test mode.

The device is provided with additional differential protection able to detect the failure of the differential switch to uncouple following a leakage in the system and to make it do so by generating a reinforced impulse directed at the relay.

The self-diagnosis function consists in making the differential switch carry out an uncoupling manoeuvre every week by simulating manual pressing of the test key.

The test consists of the following phases with an overall duration of approximately 2 minutes:

- Closing a bypass circuit in parallel with the power contacts of the differential switch
- Injecting an earth escape current equal to the rated I_{dn} current to cause the differential switch to open
- An electronic test of the condition of all the electrical and mechanical parts of the device
- Reclosing the power contacts of the differential switch by resetting the lever
- Reopening the bypass circuit and returning to the initial condition of normal operation.

The time the periodic test is made can be defined using the synchronisation function. Differential protection is present during all the test phases in any case.

THE RESTART FUNCTION

The restart function consists of automatically reclosing the differential switch if it uncouples unexpectedly due to a temporary electrical phenomenon (lightning, disturbances, etc.).

Before reclosing, the device makes a check that there is no earthing fault in the circuit downstream: if there is a fault it goes into locked status, otherwise it proceeds with reclosing.

After a third cut-in of the differential switch within three minutes of a previous automatic reset, the device goes into locked status.

To re-enable the restart function, open the hatch, raise the differential switch lever to position “I” and close the hatch.

If the differential switch will not remain in position “I”, stop trying and call a specialised technician to check the system.

The restart function cannot be activated when the differential switch is open; to activate it the differential switch lever must be raised to position “I” and the hatch closed. The test key and the differential switch lever cannot be accessed when the functions are active.

DESCRIPTION OF THE RESTART WITH AUTOTEST DEVICE

AUTOMATIC OPERATION

SELF-DIAGNOSIS AND RESTART FUNCTIONS ACTIVE

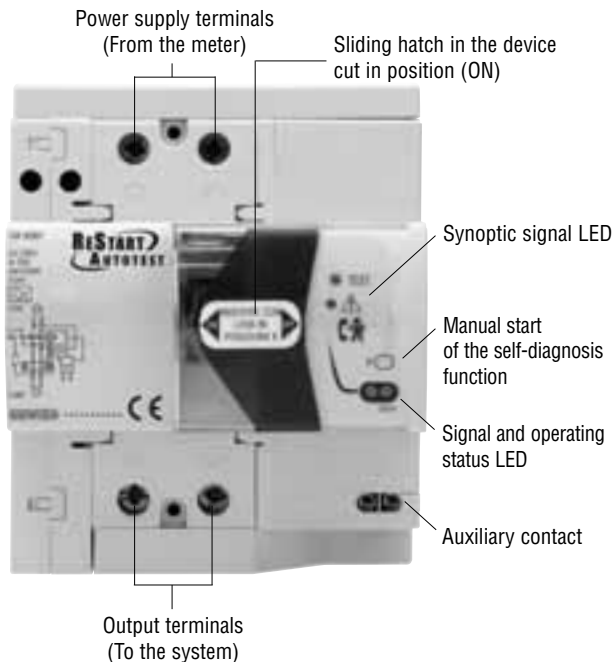

MANUAL OPERATION

SELF-DIAGNOSIS AND RESTART FUNCTIONS NOT ACTIVE



USER INSTRUCTIONS

AUTOMATIC OPERATION

CUTTING IN AUTOMATIC MODE

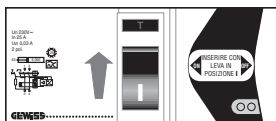

Raise the lever.
(System powered up).

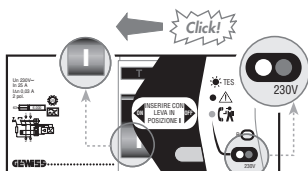

Slide the hatch until a click is heard (system powered up). Actuation confirmed by the green LED lighting up.

AUTOMATIC RESTART:

- In the case of a temporary fault

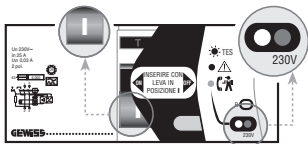

1. Normal operation.

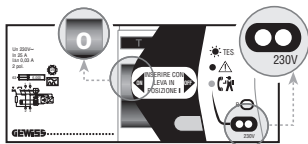

2. Tripping of the differential switch (the lever lowers, cutting off the power).

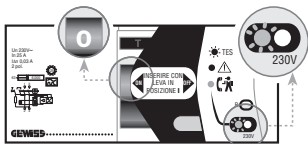

3. The device performs a test of the system of approx. 60sec. (Red indicator blinking).*

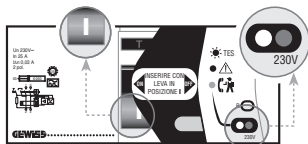

4. Reset completed (the lever rises again, powering up the system and cannot be operated manually for the next 3 minutes).

* Differential switch closing can be forced manually by going into manual mode and raising the lever. Call the installation technician if the differential switch trips again.

- In the case of a permanent fault

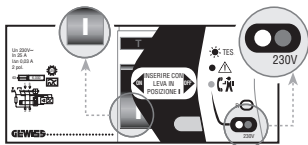

1. Normal operation.

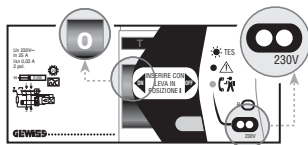

2. Tripping of the differential switch (the lever lowers, cutting off the power).

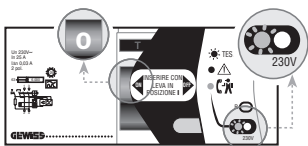

3. The device performs a test of the system of at least 20sec. (Red indicator blinking). *

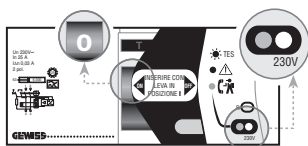

4. Reset not successful due to system problems. (System not powered up).

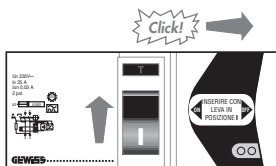

5. Attempt a manual reset by opening the hatch and raising the lever.

If the reset fails, stop attempting the reset operation and contact a specialised technician.

USER INSTRUCTIONS

AUTOMATIC TEST

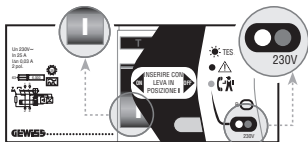

1. Normal operation.

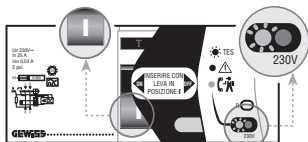

2. Start of test.

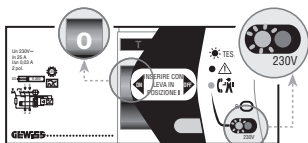

3. Automatic tripping of the switch lever (keeping the system powered up).

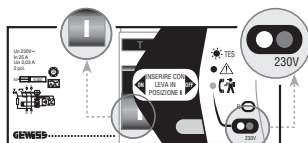

4. Reset completed. (The lever cannot be operated manually in the next three minutes).

SYNCHRONISATION

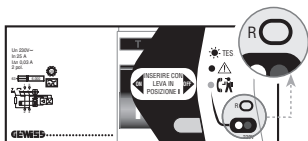

Self-diagnosis can be forced at any time by pressing key R with a narrow point (tool, pen, etc.). The weekly self-diagnosis program will be synchronised and the count of the 7 days will restart from this moment.

There might be a few minutes delay in performing the Autotest cycle if key R is pressed following a previous reset.

MANUAL OPERATION

FROM AUTOMATIC TO MANUAL



Slide the hatch until a click is heard.
(System powered up).

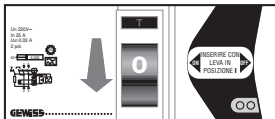

Lower the lever if the system is to be
powered down.





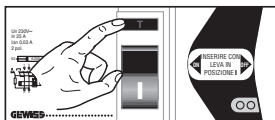



The restart and self-diagnosis functions are not performed automatically when the device is in manual mode.

MONTHLY TEST OF THE DIFFERENTIAL





















Press the test key every month in the case of
prolonged use in manual mode.
If the lever does not trip call a technician for a
check of the appliance.

LED SIGNALS

LEFT LED	RIGHT LED	DEVICE FRONT	CONDITION	AUXILIARY CONTACT
Manual operation				
○	○		Restart and self-diagnosis device not cut in. Differential switch closed. System powered up.	
○	○		Restart and self-diagnosis device not cut in. Differential switch tripped or opened intentionally. System not powered up.	
● yellow	○		Restart and self-diagnosis device fault . Call a technician for immediate replacement of the product. System not powered up. *	
● yellow	○		Restart and self-diagnosis device fault . Call a technician for immediate replacement of the product. System powered up.	

* Only attempt one manual reclosing before contacting a specialised technician.

LEFT LED	RIGHT LED	DEVICE FRONT	CONDITION	AUXILIARY CONTACT
Automatic operation				
	green		Restart and self-diagnosis device cut in. Differential switch closed. System powered up.	
	green		Self-diagnosis in progress. Wait approx. 60 seconds. System powered via the bypass.	
red			Restart and self-diagnosis device blocked due to a fault in the system downstream. Differential switch open. System not powered up.*	
			Restart and self-diagnosis device in the check for presence of a fault or reclosing phase. Opening the hatch interrupts automatic reclosing, making the manual manoeuvre possible. System not powered up.	
yellow			Restart and self-diagnosis device fault . Call a technician for immediate replacement of the product. Differential switch open. System not powered up.*	
yellow	green		Restart and self-diagnosis device fault . Call a technician for immediate replacement of the product. System powered up.	

* Only attempt one manual reclosing before contacting a specialised technician.

Key



LED off



LED on



LED blinking



Contact open



Contact active

INSTALLATION INSTRUCTIONS

INSTALLATION

The installation of the device is completely identical to that of a normal differential switch.

Ensure that the system is powered down before connecting the switch. Connect the switch as shown in the figure taking care over the power supply; it is essential that this is from above.

CONNECTION

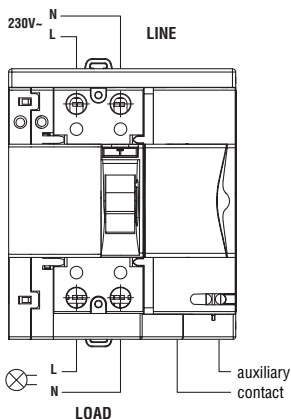

VERIFICATION TEST

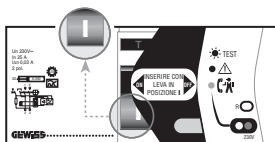

At the first start-up, trip the differential switch with the special system checking instrumentation and the device in automatic mode.

If the reset cycle is not concluded correctly check the earth insulation, which must be more than 500k Ω .

Make the connection to the mains and proceed with the activation, verification test and synchronisation.

AUXILIARY CONTACT CONFIGURATION

The auxiliary contact can be configured for various uses by simply pressing key R for 5 seconds. The move between the various modes is confirmed by red blinks from the left-hand LED.

- **Status 1 (default): operation with bell.**

On locking the NA contact switches to intermittance at a frequency of 1 Hz for 30 seconds and repeats the sequence every hour.

Pressing R
for 5 seconds



Bell

- **Status 2: operation with telephone dialler or light indicator.**

Activation confirmed by 2 blinks. On locking the NA contact switches and remains closed until the hatch is opened.

Pressing R
for 5 seconds



NC relay



Telephone
dialler

- **Status 3: communication with ACTIVO control unit.**

Activation confirmed by 3 blinks. (Refer to the ACTIVO control unit manual for the wiring diagrams).



ACTIVO control unit

Press R for 5 seconds to return to **Status 1**. Activation confirmed by 1 blink.

TECHNICAL DATA

Rated voltage Vn: 230Vac phase/neutral TT and TN

Operating voltage: from 0.85 to 1.1 Vn

Power absorbed at rest: 8 VA

Power absorbed in the blocked state: 8 VA

Rated current: - 25A GW 90 901

- 40A GW 90 902

Maximum test duration: 2 minutes

Insulation voltage towards earth: 2500V

Pure differential switch sensitivity: 30 mA

Type: A

Number of DIN modules: 5

Number of Poles: 2

Use temperature: from - 5°C to + 40°C

63  6000

Auxiliary contact

- Rated voltage: 230Vac
- Max. current: 50mA $\cos \varphi = 1$
- Min. current: 0.6mA
- Terminal cross-section: $\leq 2.5\text{mm}^2$

DIMENSIONS

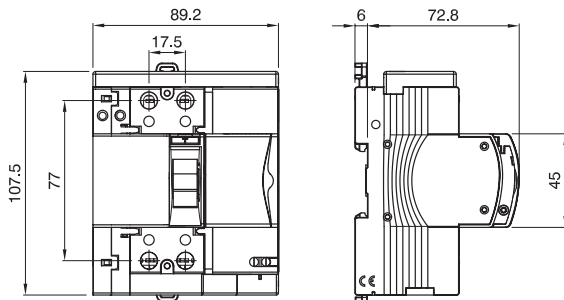

GEWISS

F R A N Ç A I S

RESTART / AUTOTEST

Série 90

AVERTISSEMENTS POUR LA SÉCURITÉ

N.B. Lire avec attention avant l'installation et l'utilisation du dispositif.

- **Ne jamais intervenir sur l'installation quand le dispositif est activé.**
- Ne pas accéder aux branchements électriques sans avoir d'abord coupé le courant à l'installation.
- Le produit n'est pas adapté à l'installation dans des réseaux phase-phase.
- Quand le dispositif est en mode manuel, il exerce la fonction de protection d'un interrupteur différentiel traditionnel.
- Quand le dispositif est en mode automatique, il effectue un contrôle périodique de fonctionnement et, en cas d'ouverture de l'interrupteur différentiel, un contrôle de l'installation afin de vérifier que le réarmement automatique puisse s'effectuer en conditions de sécurité.
- D'éventuelles positions intermédiaires du levier de l'interrupteur ne comportent pas d'anomalies de fonctionnement si elles sont temporaires.
- S'il faut couper manuellement le courant à l'installation dans un délai de trois minutes après un réarmement automatique, agir, après avoir ouvert le volet, sur le bouton de test de l'interrupteur différentiel (ou sur les interrupteurs branchés en aval).
- Des déclics du levier et des bruits pendant le cycle d'autodiagnostic sont absolument normaux.

SOMMAIRE

• Fonction du produit	36
- Fonction d'autodiagnostic	36
- Fonction de réarmement	37
• Descriptions du dispositif RESTART / AUTOTEST	38
- Fonctionnement automatique	38
- Fonctions d'autodiagnostic et réarmement activées	38
- Fonctionnement manuel	39
- Fonctions d'autodiagnostic et réarmement désactivées	39
• Instructions pour l'utilisation	40
- Fonctionnement automatique	40
- Activation mode automatique	40
- Réarmement automatique	40
- Test automatique	42
- Synchronisation	42
- Fonctionnement manuel	43
- D'automatique à manuel	43
- Test mensuel de l'interrupteur différentiel	43
• Signalisation des leds	44
• Instructions pour l'installation	46
- Installation	46
- Branchement	46
- Test de contrôle	46
- Configuration du contact auxiliaire	47
• Caractéristiques techniques	48
• Dimensions	48

FONCTIONS DU PRODUIT

FONCTION D'AUTODIAGNOSTIC

Le RESTART / AUTOTEST est un dispositif qui prévoit la possibilité d'effectuer un autodiagnostic hebdomadaire, aussi bien électrique que mécanique, sans devoir couper l'alimentation de l'installation à laquelle il est branché.

Si des anomalies sont constatées lors de l'exécution du test, la condition de panne possible est signalée.

Le dispositif est équipé d'une protection différentielle supplémentaire en mesure de détecter l'absence de déclenchement de l'interrupteur différentiel en cas de fuite permanente dans l'installation et de le provoquer au moyen d'une impulsion renforcée dirigée vers le relais.

La fonction d'autodiagnostic consiste dans l'exécution, chaque semaine, d'une manoeuvre de déclenchement de l'interrupteur différentiel en simulant la pression manuelle sur le bouton de test.

Le test est constitué des phases suivantes, pour une durée totale d'environ 2 minutes:

- fermeture d'un circuit de by-pass en parallèle aux contacts de puissance de l'interrupteur différentiel
- injection d'un courant de fuite à la terre égal au courant nominal I_{dn} , afin de provoquer l'ouverture de l'interrupteur différentiel
- test électronique de l'état de toutes les pièces mécaniques et des composants électriques du dispositif
- fermeture des contacts de puissance de l'interrupteur différentiel au moyen du réarmement du levier
- ouverture du circuit de by-pass et retour à l'état initial de fonctionnement normal.

Il est possible de programmer l'heure d'exécution du test périodique au moyen de la fonction de synchronisation. Dans tous les cas, la protection différentielle est assurée pendant toutes les phases du test.

FONCTION DE RÉARMEMENT

La fonction de réarmement consiste dans la fermeture automatique de l'interrupteur différentiel en cas de déclenchement intempestif suite à des phénomènes électriques temporaires (foudres, perturbations, etc.). Avant de procéder à l'action de fermeture, le dispositif effectue un contrôle d'absence de pannes vers la terre sur le circuit en aval: si une panne est détectée, le dispositif se place en état d'arrêt; en cas contraire, il effectue la fermeture.

Si l'interrupteur différentiel intervient trois fois dans un intervalle de trois minutes après un réarmement automatique, le dispositif se place en état d'arrêt.

Pour réactiver la fonction de réarmement, ouvrir le volet, soulever le levier de l'interrupteur différentiel sur la position " I " et fermer le volet.

Si l'interrupteur différentiel ne reste pas sur la position " I ", arrêter les tentatives et appeler un électricien qualifié pour faire contrôler l'installation.

Il n'est pas possible d'activer la fonction de réarmement quand l'interrupteur différentiel est ouvert. Pour réactiver la fonction, il faut soulever le levier de l'interrupteur différentiel sur la position " I " et fermer le volet. Quand les fonctions sont activées, le bouton de test et le levier de l'interrupteur différentiel ne sont pas accessibles.

DESCRIPTIONS DU DISPOSITIF RESTART / AUTOTEST

FONCTIONNEMENT AUTOMATIQUE

FONCTIONS D'AUTODIAGNOSTIC ET RÉARMEMENT ACTIVÉES

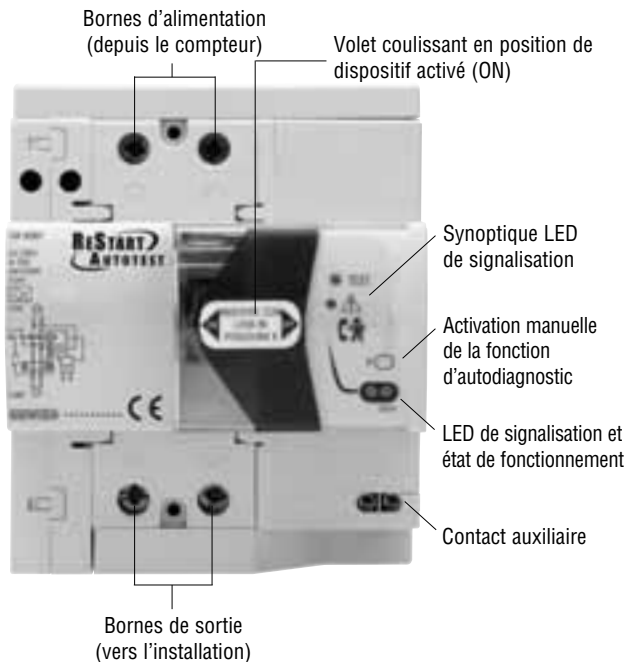

FONCTIONNEMENT MANUEL

FONCTIONS D'AUTODIAGNOSTIC ET RÉARMEMENT DÉSACTIVÉES



INSTRUCTIONS POUR L'UTILISATION

FONCTIONNEMENT AUTOMATIQUE

ACTIVATION MODE AUTOMATIQUE

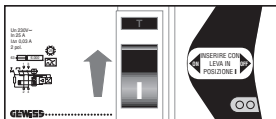

Soulever le levier
(Installation sous tension).

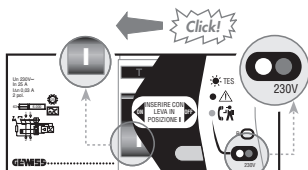

Faire coulisser le volet jusqu'à entendre l'enclenchement (installation sous tension). L'activation est confirmée par l'allumage de la LED de couleur verte.

RÉARMEMENT AUTOMATIQUE:

- En cas de panne temporaire

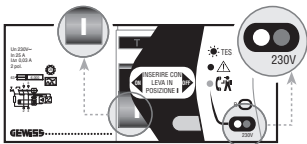

1. Fonctionnement normal.

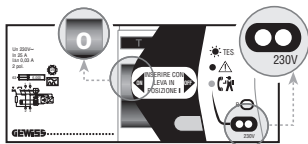

2. Déclenchement de l'interrupteur différentiel (le levier se baisse en coupant le courant).

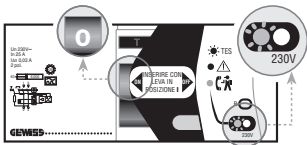

3. Le dispositif effectue un test de l'installation d'environ 60 s (LED rouge clignotante). *

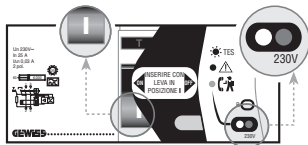

4. Réarmement exécuté (le levier se soulève en remettant sous tension l'installation; dans les 3 minutes successives, il ne peut pas être actionné manuellement).

* On peut forcer manuellement la fermeture de l'interrupteur différentiel en passant en mode manuel et en soulevant le levier. Si l'interrupteur différentiel intervient encore, appeler l'installateur.

- En cas de panne permanente

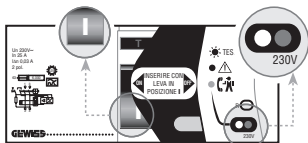

1. Fonctionnement normal.

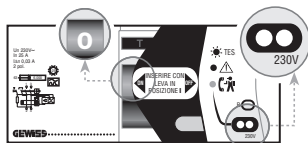

2. Déclenchement de l'interrupteur différentiel (le levier se baisse en coupant le courant).



3. Le dispositif effectue un test de l'installation d'au moins 20 s (LED rouge clignotante). *

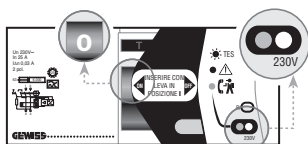

4. Réarmement non exécuté à cause de problèmes de l'installation (Installation non alimentée).

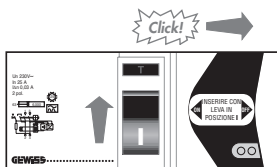

5. Effectuer une tentative de réarmement manuel en ouvrant le volet et en soulevant le levier. Si le réarmement est impossible, ne pas insister et contacter un électricien qualifié.

INSTRUCTIONS POUR L'UTILISATION

TEST AUTOMATIQUE

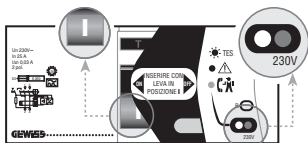

1. *Fonctionnement normal.*

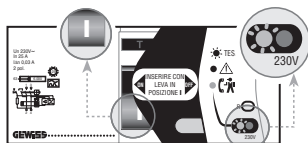

2. *Démarrage test*

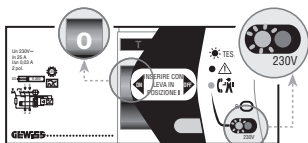

3. *Intervention automatique levier interrupteur (en maintenant l'installation sous tension).*

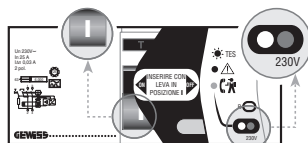

4. *Réarmement exécuté. (Au cours des 3 minutes suivantes, le levier ne peut pas être actionné manuellement).*

SYNCHRONISATION

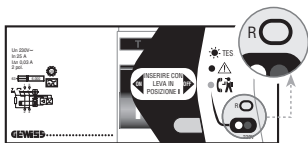

Il est possible de forcer à tout moment l'autodiagnostic en appuyant sur le bouton R avec une pointe fine (outil, crayon, ...). Le programme hebdomadaire d'autodiagnostic sera synchronisé et le comptage des 7 jours redémarra à partir de ce moment.

Il est possible qu'il y ait quelques minutes de retard dans l'exécution du cycle d'autotest si on a appuyé sur la touche R à la suite d'une mise à zéro précédente.

FONCTIONNEMENT MANUEL

D'AUTOMATIQUE À MANUEL



Faire coulisser le volet jusqu'à entendre l'enclenchement (Installation sous tension).

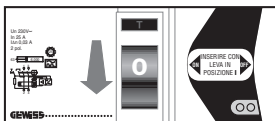

Si l'on veut couper le courant à l'installation, abaisser le levier.

Quand le dispositif fonctionne en mode manuel, les fonctions de réarmement et auto-diagnostic ne sont pas effectuées automatiquement.

TEST MENSUEL DE L'INTERRUPTEUR DIFFÉRENTIEL

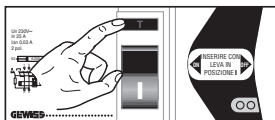



















En cas d'utilisation prolongée en mode manuel, appuyer sur le bouton de test tous les mois. Si le levier ne se déclenche pas, appeler un électricien pour faire contrôler le dispositif.

SIGNALISATION DES LEDS

LED GAUCHE	LED DROITE	FAÇADE DISPOSITIF	CONDITION	CONTACT AUXILIAIRE
Fonctionnement manuel				
			Dispositif de réarmement et autodiagnostic désactivé . Interrupteur différentiel fermé. Installation alimentée.	
			Dispositif de réarmement et autodiagnostic désactivé . Interrupteur différentiel déclenché ou ouvert intentionnellement. Installation non alimentée.	
 jaune			Dispositif de réarmement et autodiagnostic en panne . Appeler un électricien pour le remplacement immédiat du produit. Installation non alimentée.*	
 jaune			Dispositif de réarmement et autodiagnostic en panne . Appeler un électricien pour le remplacement immédiat du produit. Installation alimentée.	

* Avant de contacter un électricien qualifié, essayer, une seule fois, la fermeture manuelle.

LED GAUCHE	LED DROITE	FAÇADE DISPOSITIF	CONDITION	CONTACT AUXILIAIRE
Fonctionnement automatique				
	verte		Dispositif de réarmement et autodiagnostic activé. Interrupteur différentiel fermé. Installation alimentée.	
	verte		Autodiagnostic en cours. Attendre environ 60 secondes. Installation alimentée par dérivation.	
rouge			Dispositif de réarmement et autodiagnostic en état d' arrêt pour panne de l'installation en aval. Interrupteur différentiel ouvert. Installation non alimentée.*	
			Dispositif de réarmement et autodiagnostic en phase de contrôle présence panne ou fermeture . L'ouverture du volet interrompt la fermeture automatique en rendant possible la manoeuvre manuelle. Installation non alimentée.	
jaune			Dispositif de réarmement et autodiagnostic en panne . Appeler un électricien pour le remplacement immédiat du produit. Interrupteur différentiel ouvert. Installation non alimentée.*	
jaune	verte		Dispositif de réarmement et autodiagnostic en panne . Appeler un électricien pour le remplacement immédiat du produit. Installation alimentée.	

* Avant de contacter un électricien qualifié, essayer, une seule fois, la fermeture manuelle.

Légende



LED éteinte



LED allumée



LED clignotante



Contact ouvert



Contact activé

INSTRUCTIONS POUR L'INSTALLATION

INSTALLATION

L'installation du dispositif s'effectue de la même façon que pour un interrupteur différentiel normal.

Avant de brancher l'interrupteur, s'assurer que l'installation est hors tension.

Brancher l'interrupteur de la façon indiquée sur la figure, en veillant à l'alimentation, qui doit être obligatoirement exécutée depuis le haut.

BRANCHEMENT

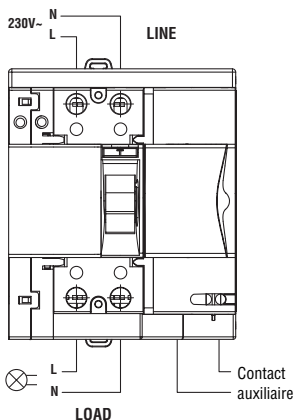

TEST DE CONTRÔLE

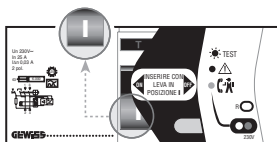

Lors de la première mise en service, faire déclencher l'interrupteur différentiel avec les instruments de contrôle installation prévus à cet effet et avec le dispositif en fonctionnement automatique. Si le cycle de réarmement n'est pas effectué correctement, vérifier l'isolation vers la terre de l'installation, qui doit dépasser 500k Ω .

Une fois le branchement au réseau effectué, procéder à l'activation, au test de contrôle et à la synchronisation.

CONFIGURATION DU CONTACT AUXILIAIRE

Il est possible de configurer le contact auxiliaire pour différents usages, simplement en maintenant appuyée la touche R pendant 5". Le passage entre les différents modes est confirmé par le clignotement rouge de la del de gauche.

- **État 1 (default) : fonctionnement avec sonnerie.**

Au verrouillage le contact NA commute en mode intermittent avec une fréquence de 1Hz pendant 30 secondes, et répète la séquence toutes les heures.

Pression sur
R pendant 5"



Sonnerie

- **État 2 : fonctionnement avec coupleur téléphonique ou témoin lumineux.**

L'activation est confirmée par 2 clignotements. Au verrouillage le contact NA commute et reste fermé jusqu'à ce qu'on ouvre le couvercle.

Pression sur
R pendant 5"



Relais NC



Coupleur
téléphonique

- **État 3 : communication avec le central ACTIVO.**

L'activation est confirmée par 3 clignotements. (Pour les schémas de câblage se référer au manuel du central ACTIVO).



Central ACTIVO

Pour retourner à l'État 1, maintenir R appuyé pendant 5". L'activation est confirmée par 1 clignotement.

CARACTÉRISTIQUES TECHNIQUES

Tension nominale: 230Vc.a. phase/neutre TT et TN

Tension de monitoring: de 0.85 à 1.1 Vn

Puissance absorbée au repos: 8 VA

Puissance absorbée en état d'arrêt: 8 VA

Courant nominal: - 25A GW 90 901

- 40A GW 90 902

Durée maximum du test: 2 minutes

Tension d'isolation vers la masse: 2500V

Sensibilité interrupteur différentiel pur: 30 mA

Type: A

N. modules DIN: 5

Nombre de Pôles: 2

Température d'utilisation: de -5°C à +40°C

63  6000

Contact auxiliaire

- Tension nominale: 230Vc.a.

- Courant max.: 50mA $\cos \varphi = 1$

- Courant min.: 0.6mA

- Section bornes: $\leq 2,5\text{mm}^2$

DIMENSIONS

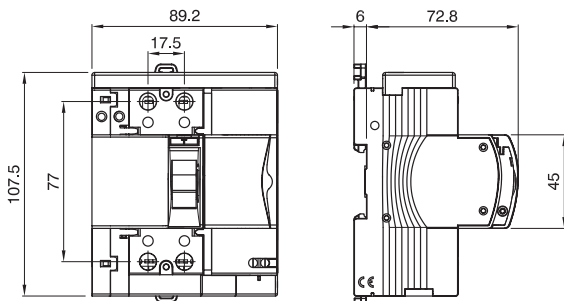

GEWISS

E S P A Ñ O L

RESTART / AUTOTEST

Serie 90

ADVERTENCIAS PARA LA SEGURIDAD

N.B. Leer atentamente antes de la instalación y del uso del dispositivo

- **No intervenga nunca en la instalación con el dispositivo introducido.**
- No acceda a las conexiones eléctricas sin haber eliminado la tensión en la instalación.
- El producto no es idóneo para la instalación en redes entre fases.
- Cuando el dispositivo está en modalidad manual, desarrolla la función de protección de un interruptor diferencial tradicional.
- Cuando el dispositivo está en modalidad automática desarrolla un control periódico de funcionalidad y un control de la instalación, después de la apertura del interruptor diferencial, para comprobar la posibilidad de restablecimiento automático en seguridad.
- Posibles posiciones intermedias de la palanca no constituyen mal funcionamiento si son temporales.
- Si es necesario cortar manualmente la corriente de la instalación antes de 3 minutos a causa de un rearme automático, actuar en el pulsador de test del interruptor diferencial después de la apertura de la ventanilla (o en los interruptores conectados en entrada).
- Disparos de la leva y ruidos durante el ciclo de autodiagnos son absolutamente normales.

INDICE

• Funciones de producto	52
- Función de autodiagnóstico	52
- Función de rearme	53
• Descripciones del dispositivo RESTART con AUTOTEST	54
- Funcionamiento automático	54
- Funciones de autodiagnóstico y rearme activas	54
- Funcionamiento manual	55
- Funciones de autodiagnóstico y rearme no activas	55
• Instrucciones para el uso	56
- Funcionamiento automático	56
- Introducción modalidad automática	56
- Rearme automático	56
- Test automático	58
- Sincronización	58
- Funcionamiento manual	59
- De automático a manual	59
- Test mensual del diferencial	59
• Señalización de los led	60
• Instrucciones para la instalación	62
- Instalación	62
- Conexión	62
- Test de control	62
- Configuración del contacto auxiliar	63
• Características técnicas	64
• Dimensiones	64

FUNCIONES DE PRODUCTO

FUNCIÓN DE AUTODIAGNÓSTICO

RESTART / AUTOTEST es un dispositivo que incorpora la posibilidad de efectuar un autodiagnosis semanal tanto eléctrico como mecánico, sin interrupción de la alimentación de la instalación conectada al mismo.

Si durante la modalidad de test se detectan anomalías, se señala la condición de posible avería.

El dispositivo está dotado de protección diferencial añadida capaz de detectar, después de una dispersión en la instalación, la falta de desenganche del interruptor diferencial y de provocarlo generando un impulso reforzado directo al relé.

La función de autodiagnóstico consiste en efectuar cada semana una maniobra de desenganche del interruptor diferencial simulando la presión manual de la tecla de test.

El test se compone de las siguientes fases de la duración total de unos 2 minutos:

- Cierre de un circuito de by-pass en paralelo con los contactos de potencia del interruptor diferencial
- Inyección de una corriente de pérdida de tierra equivalente a la corriente nominal I_{dn} para procurar la apertura del interruptor diferencial
- Test electrónico del estado de todas las partes mecánicas y eléctricas del dispositivo
- Cierre de los contactos de potencia del interruptor diferencial mediante rearme de la palanca
- Reapertura del circuito by-pass y vuelta al estado inicial de funcionamiento normal.

Es posible establecer el horario de ejecución del test periódico mediante la función de sincronización. Durante todas las fases del test está presente la protección diferencial.

FUNCIÓN DE REARME

La función de rearme consiste en el cierre automático del interruptor diferencial en caso de desenganche intempestivo por fenómeno eléctrico temporal (rayos, perturbaciones, etc)

Antes de proceder con la acción de cierre el dispositivo efectúa un control de ausencia de avería en tierra en el circuito de entrada: si se detecta una avería se lleva a estado de bloqueo, de lo contrario procede con el cierre.

Después de una tercera intervención del interruptor diferencial antes de tres minutos de un precedente rearme automático, el dispositivo se lleva a estado de bloqueo.

Para rehabilitar la función de rearme, abrir la ventanilla, levantar la palanca del interruptor diferencial en posición “I” y cerrar la ventanilla.

Si el interruptor diferencial no permanece en posición “I”, suspender los tentativos y contactar un técnico especializado para comprobar la instalación.

No es posible activar la función de rearme con el interruptor diferencial abierto. Para activarla es necesario levantar la palanca del interruptor diferencial en posición “I” y cerrar la ventanilla. Con las funciones activadas la tecla de test y la palanca del interruptor diferencial no son accesibles.

DESCRIPCIONES DEL DISPOSITIVO RESTART CON AUTOTEST

FUNCIONAMIENTO AUTOMÁTICO

FUNCIONES DE AUTODIAGNÓSTICO Y REARME ACTIVAS

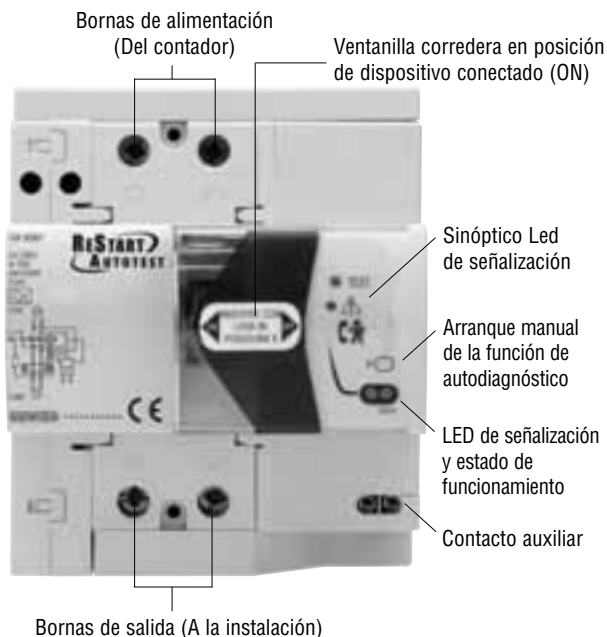

FUNCIONAMIENTO MANUAL

FUNCIONES DE AUTODIAGNÓSTICO Y REARME NO ACTIVAS

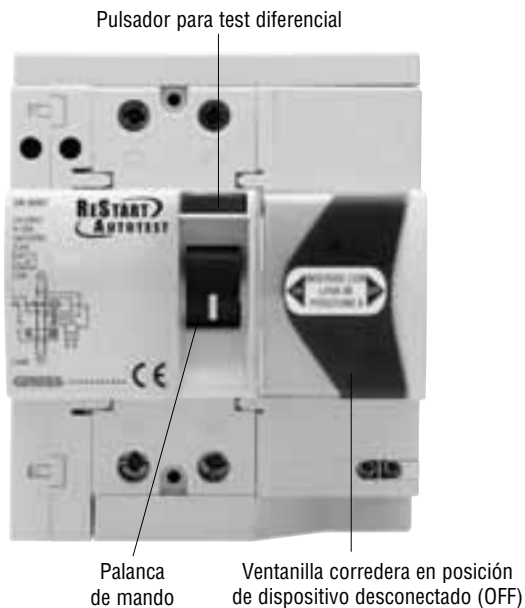

INSTRUCCIONES PARA EL USO

FUNCIONAMIENTO AUTOMÁTICO

INTRODUCCIÓN MODALIDAD AUTOMÁTICA

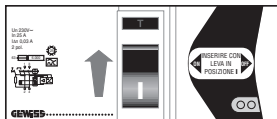

Levantar la palanca.
(Instalación bajo tensión).

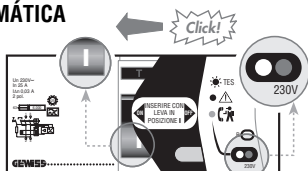

Desplazar la ventanilla hasta escuchar el enganche (instalación bajo tensión). Activación confirmada por el encendido del led verde.

REARME AUTOMÁTICO:

- En caso de avería temporal

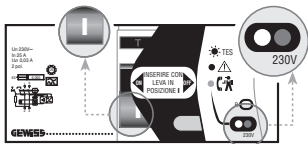

1. Funcionamiento normal.

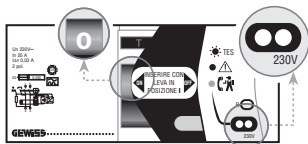

2. Disparo del interruptor diferencial (la palanca se baja eliminando tensión).

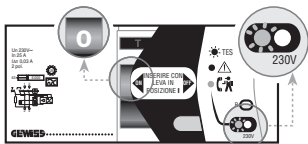

3. El aparato realiza un test de la instalación de unos 60 seg. (Dispositivo luminoso rojo parpadeante). *

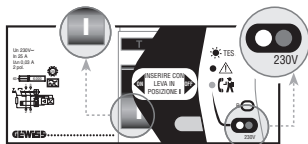

4. Rearme efectuado (la palanca se levanta dando tensión a la instalación, y en los 3 minutos sucesivos no se puede accionar manualmente).

* Es posible forzar manualmente el cierre del interruptor diferencial pasando a la modalidad manual y levantando la palanca. En el caso en el que el interruptor diferencial se dispare de nuevo, llame al instalador.

- En caso de avería permanente

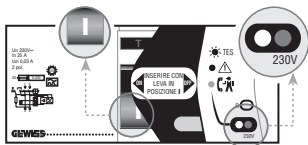

1. Funcionamiento normal.

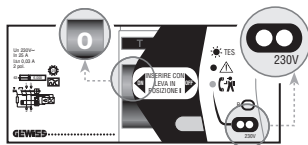

2. Disparo del interruptor diferencial (la palanca se baja eliminando tensión).

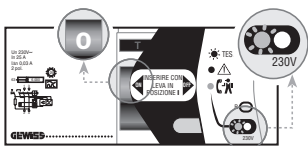

3. El aparato realiza un test de la instalación de unos 20 seg. (Dispositivo luminoso rojo parpadeante).*

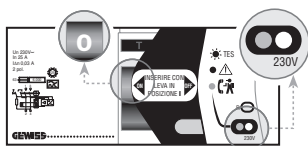

4. Rearme no efectuado por problemas en la instalación. (Instalación no en tensión).

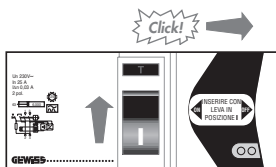

5. Proceder con un tentativo de rearme manual abriendo la ventanilla y levantando la palanca. En caso de falta de reactivación no continúe la operación de rearme y contacte un técnico especializado.

INSTRUCCIONES PARA EL USO

TEST AUTOMÁTICO

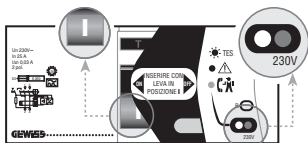

1. Funcionamiento normal.

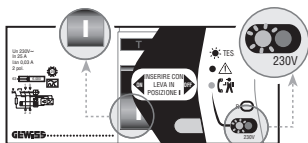

2. Inicio del test.

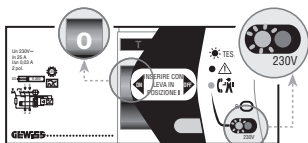

3. Disparo automático de la leva del interruptor (manteniendo la tensión en la instalación).

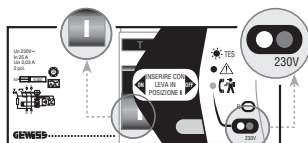

4. Rearme efectuado. (En los 3 minutos sucesivos la palanca no se puede accionar manualmente)

SINCRONIZACIÓN

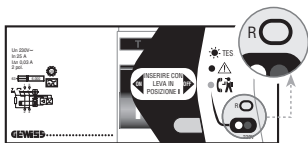

Es posible en cualquier momento forzar el diagnóstico automático presionando la tecla R con una punta fina (herramienta, bolígrafo...). El programa semanal de auto-diagnóstico se sincronizará y el recuento de los 7 días partirá desde este momento.

Es posible que se verifique algún minuto de retraso en la realización del ciclo de autotest si la tecla R se presiona después de un precedente rearme.

FUNCIONAMIENTO MANUAL

DE AUTOMÁTICO A MANUAL



Desplazar la ventanilla hasta escuchar el disparo. (Instalación bajo tensión).

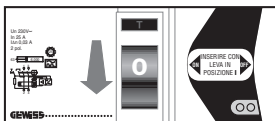

Si se desea eliminar tensión en la instalación bajar la palanca.

Con el dispositivo en funcionamiento manual no se realizan automáticamente las funciones de rearme y autodiagnóstico.

TEST MENSUAL DEL DIFERENZIAL

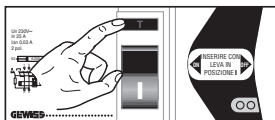

















Si se efectuara un uso prolongado en modalidad manual presionar la tecla de test cada mes. Si la palanca no se dispara llamar a un técnico para el control del aparato.

SEÑALIZACIÓN DE LOS LED

LED IZQ	LED DCH	FRONTAL DISPOSITIVO	CONDICIÓN	CONTACTO AUXILIAR
Funcionamiento manual				
○	○		Dispositivo de rearme y autodiagnóstico no introducido. Interruptor diferencial cerrado. Instalación alimentada.	
○	○		Dispositivo de rearme y autodiagnóstico no introducido. Interruptor diferencial disparado o abierto intencionalmente. Instalación no alimentada.	
● amarillo	○		Dispositivo de rearme y Autodiagnóstico averiado . Llamar a un técnico para sustituir el producto inmediatamente. Instalación no alimentada.*	
● amarillo	○		Dispositivo de rearme y Autodiagnóstico averiado . Llamar a un técnico para sustituir el producto inmediatamente. Instalación alimentada.	

* Antes de contactar un técnico especializado tentar un solo cierre manual.

LED IZQ	LED DCH	FRONTAL DISPOSITIVO	CONDICIÓN	CONTACTO AUXILIAR
Funcionamiento automático				
	verde		Dispositivo de rearme y autodiagnóstico introducido. Interruptor diferencial cerrado. Instalación alimentada.	
	verde		Autodiagnóstico en curso. Esperar unos 60 segundos. Instalación alimentada mediante by-pass.	
rojo			Dispositivo de rearme y Autodiagnóstico bloqueado por avería de la instalación en entrada. Interruptor diferencial abierto. Instalación no alimentada.*	
rojo			Dispositivo de rearme y Autodiagnóstico en fase de control presencia avería o cierre . La apertura de la ventanilla interrumpe el cierre automático permitiendo maniobrar manualmente. Instalación no alimentada.	
amarillo			Dispositivo de rearme y Autodiagnóstico averiado. Llamar a un técnico para sustituir el producto inmediatamente. Interruptor diferencial abierto. Instalación no alimentada.*	
amarillo	verde		Dispositivo de rearme y Autodiagnóstico averiado . Llamar a un técnico para sustituir el producto inmediatamente. Instalación alimentada.	

* Antes de contactar un técnico especializado tentar un solo cierre manual.

Leyenda



Led apagado



Led encendido



Led intermitente



Contacto abierto



Contacto activo

INSTRUCCIONES PARA LA INSTALACIÓN

INSTALACIÓN

La instalación del dispositivo es igual que la de un interruptor diferencial normal.

Antes de conectar el interruptor asegúrese de que no haya tensión en la instalación.

Conectar el interruptor como se indica en la figura prestando atención a la alimentación que deberá efectuarse desde arriba.

CONEXIÓN

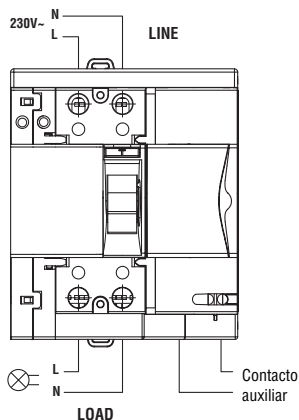

TEST DE CONTROL

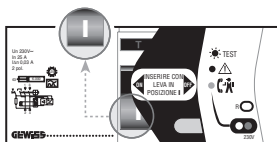

En la primera puesta en servicio, disparar el interruptor diferencial con las correspondientes instrumentaciones de control de la instalación y el dispositivo en funcionamiento automático. En el caso en el que el ciclo de rearme no se concluya correctamente comprobar el aislamiento hacia tierra de la instalación, que debe superar los 500k Ω .

Efectuada la conexión a la red, procédase con la activación, test de control y la sincronización.

CONFIGURACIÓN DEL CONTACTO AUXILIAR

Es posible configurar el contacto auxiliar para diferentes usos simplemente con la presión prolongada durante 5" de la tecla R. El paso entre las diferentes modalidades es confirmado por intermitencias rojas del led de la izquierda.

- **Estado 1 (default): funcionamiento con dispositivo sonoro.**

Con el bloqueo el contacto NA conmuta en intermitente con frecuencia 1Hz durante 30 segundos y repite la secuencia cada hora.

Presión de R
durante 5"



Dispositivo sonoro

- **Estado 2: funcionamiento con combinador telefónico o indicador luminoso.**

Activación confirmada por 2 intermitencias. Con el bloqueo el contacto NA conmuta y permanece cerrado hasta la apertura de la ventanilla.

Presión de R
durante 5"



Relé NC



Combinador telefónico

- **Estado 3: comunicación con la central ACTIVO.**

Activación confirmada por 3 intermitencias. (Para los esquemas de cableado hágase referencia al manual de la central ACTIVO).



Central ACTIVO

Para volver al **Estado 1** presione R durante 5". Activación confirmada por 1 intermitencia.

CARACTERÍSTICAS TÉCNICAS

Tensión nominal Vn: 230Vac fase/neutro TT y TN

Tensión de funcionamiento: da 0.85 a 1.1 Vn

Potencia absorbida en reposo: 8 VA

Potencia absorbida en estado de bloqueo: 8 VA

Corriente nominal: - 25A GW 90 901

- 40A GW 90 902

Duración máxima del test: 2 minutos

Tensión de aislamiento hacia masa: 2500V

Sensibilidad interruptor diferencial puro: 30 mA

Tipo: A

Nº módulos DIN: 5

Número de Polos: 2

Temperatura de empleo: de -5°C a +40°C

63  6000

Contacto auxiliar

- Tensión nominal: 230Vac
- Corriente máx: 100mA $\cos \varphi = 1$
- Corriente mín: 0,6mA
- Sección bornas: $\leq 2,5\text{mm}^2$

DIMENSIONES

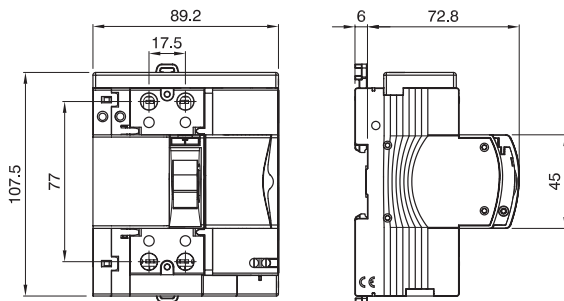

GEWISS

D E U T S C H

RESTART / AUTOTEST

Serie 90

SICHERHEITSHINWEISE

Hinweis: Lesen Sie vor der Installation und Verwendung des Geräts die Anleitung aufmerksam durch.

- **Nie an Elektroanlagen mit eingeschaltetem Gerät arbeiten.**
- Nie auf die elektrischen Anschlüsse zugreifen, ohne die Anlage zuvor spannungsfrei geschaltet zu haben.
- Das Produkt ist für eine Installation in Phase/Phase Netze nicht geeignet.
- Wenn sich das Gerät in manuellem Betrieb befindet, erfüllt es die Schutzfunktion eines herkömmlichen FI-Schutzschalters.
- Wenn sich das Gerät in automatischem Betrieb befindet, erfolgt eine regelmäßige Kontrolle, und nach einer Auslösung des FI-Schutzschalters eine Überprüfung der Elektroanlage, um die Möglichkeit einer sicheren Rückstellung zu prüfen.
- Eventuelle Zwischenstellungen des Hebels stellen, solange sie vorübergehend sind, keine Fehlfunktion dar.
- Falls die Versorgung der Anlage von Hand innerhalb von 3 Minuten nach einer automatischen Rückstellung getrennt werden soll, muss vor dem Öffnen der Klappe die Testtaste des FI-Schutzschalters betätigt werden (oder die Testtaste der Schutzschalter im angeschlossenen Verbrauchernetz).
- Ein Schnappen des Hebels und Geräusche während des Selbstdiagnosenzyklus sind vollkommen normal.

INHALTSVERZEICHNIS

• Produktfunktionen	68
- Autodiagnosefunktion	68
- Rückstellfunktion	69
• Beschreibung des ReStart-geräts mit Autotest	70
- Automatikfunktion.....	70
- Autodiagnosefunktion und rückstellung aktiv.....	70
- Manuelle funktion	71
- Autodiagnosefunktion und rückstellung nicht aktiv	71
• Gebrauchsanweisung	72
- Automatikfunktion.....	72
- Automatische aktivierung	72
- Automatische rückstellung	72
- Automatiktest	74
- Synchronisierung	74
- Manuelle funktion	75
- Von automatik auf manuell.....	75
- Monatlicher test des fi-schutzschalters	75
• Anzeigen der led	76
• Hinweise zur installation	78
- Installation	78
- Anschluss	78
- Überprüfung	78
- Konfiguration des Hilfskontakts	79
• Technische eigenschaften	80
• Abmessungen	80

PRODUKTFUNKTIONEN

AUTODIAGNOSEFUNKTION

RESTART / AUTOTEST ist ein Gerät, mit dem eine wöchentliche, elektrische und mechanische Selbstdiagnose ausgeführt werden kann, ohne dass die Stromversorgung des angeschlossenen Netzes unterbrochen wird.

Falls während des Tests Anomalien festgestellt werden, wird die Möglichkeit eines vorhandenen Defekts angezeigt.

Das Gerät ist mit einem zusätzlichen FI-Schutz ausgestattet, das nach einem aufgetretenen Fehlstrom in der Anlage das Nichtauslösen des FI-Schutzschalters erkennt, und ein Auslösen durch das Generieren eines verstärkten Impulses in Richtung des Relais erzwingt.

Die Autodiagnosefunktion besteht in der wöchentlichen Auslösung des FI-Schutzschalters, wodurch das manuelle Betätigen der Testtaste simuliert wird.

Der Test besteht aus den folgenden Phasen mit einer Gesamtdauer von ca. 2 Minuten:

- Schließen eines By-Passkreises parallel zu den Leistungskontakten des FI-Schutzschalters
- Generieren eines Kriechstroms zur Erde in Höhe des Nennstroms I_{dn} , um ein Auslösen des FI-Schutzschalters zu erreichen
- Elektronischer Test des Zustands aller mechanischen und elektrischen Bauteile des Geräts
- Erneutes Schließen der Leistungskontakten des FI-Schutzschalters durch Rückstellen des Hebels
- Erneutes Öffnen des By-Passkreises und Rückkehr zum ursprünglichen Zustand der normalen Funktion.

Mittels der Synchronisierungsfunktion kann die Uhrzeit zur Ausführung des regelmäßigen Tests festgelegt werden. Während aller Testphasen steht der FI-Schutz fortlaufend zur Verfügung.

RÜCKSTELLFUNKTION

Die Rückstellfunktion besteht aus dem automatischen Schließen des FI-Schutzschalters bei unangebrachten Auslösungen aufgrund vorübergehender elektrischer Phänomene (Blitzschlag, Netzschwankungen, usw.)

Vor dem erneuten Schließen führt das Gerät eine Kontrolle durch, um Erdschlüsse im angeschlossenen Verbrauchernetz festzustellen: Falls ein Defekt festgestellt wird, verriegelt sich das Gerät, andernfalls erfolgt das erneute Schließen des FI-Schutzschalters.

Nach dem dritten Ansprechen des FI-Schutzschalters innerhalb von drei Minuten nach einer vorhergehenden automatischen Rückstellung verriegelt sich das Gerät.

Um die Rückstellfunktion erneut zu aktivieren, muss die Klappe geöffnet, der Hebel des FI-Schutzschalters auf Stellung „I“ gestellt und die Klappe wieder geschlossen werden. Falls der FI-Schutzschalter nicht in der Stellung „I“ verbleibt, muss der Rückstellversuch unterbrochen, und ein Elektriker zur Überprüfung der Anlage gerufen werden.

Die Rückstellfunktion kann nicht bei ausgelöstem FI-Schutzschalter aktiviert werden. Um die Funktion zu aktivieren, muss der Hebel des FI-Schutzschalters auf Stellung „I“ gestellt, und die Klappe geschlossen werden. Bei aktivierter Funktion sind die Testtaste und der Hebel des FI-Schutzschalters nicht zugänglich.

BESCHREIBUNG DES RESTART-GERÄTS MIT AUTOTEST

AUTOMATIKFUNKTION

AUTODIAGNOSEFUNKTION UND RÜCKSTELLUNG AKTIV

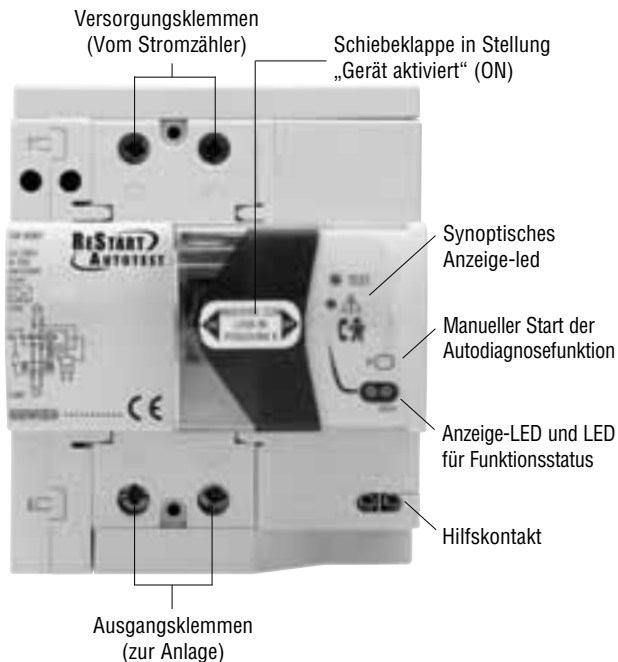

MANUELLE FUNKTION

AUTODIAGNOSEFUNKTION UND RÜCKSTELLUNG NICHT AKTIV



GEBRAUCHSANWEISUNG

AUTOMATIKFUNKTION

AUTOMATISCHE AKTIVIERUNG

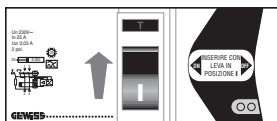

Hebel anheben.
(Anlage mit Strom versorgt).

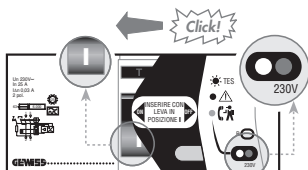

Die Klappe bis zum hörbaren Einrasten verschieben (Anlage mit Strom versorgt). Aktivierung wird durch Aufleuchten der grünen LED bestätigt.

AUTOMATISCHE RÜCKSTELLUNG:

- Bei vorübergehendem Defekt

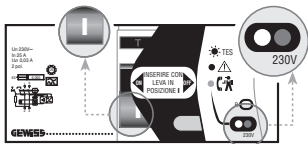

1. Normale Funktion

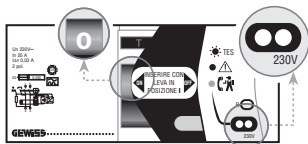

2. Auslösen des FI-Schutzschalters (der Hebel senkt sich und unterbricht die Stromversorgung).

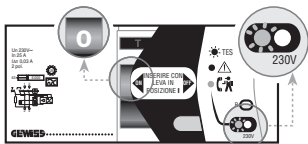

3. Das Gerät führt für ca. 60 s eine Überprüfung der Anlage aus (rote Leuchte blinkt). *

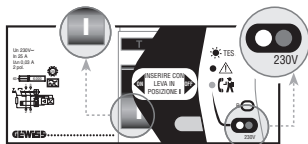

4. Rückstellung ausgeführt (der Hebel hebt sich, versorgt die Anlage wieder mit Spannung, und kann für die folgenden 3 Minuten nicht von Hand betätigt werden).

* Das manuelle Auslösen des FI-Schutzschalters kann durch Wechseln in den manuellen Modus und Anheben des Hebels erzwungen werden. Falls der FI-Schutzschalter erneut auslöst, muss ein Elektriker gerufen werden.

- Bei dauerndem Defekt

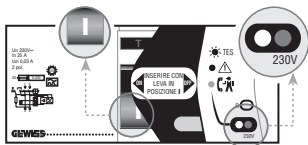

1. Normale Funktion

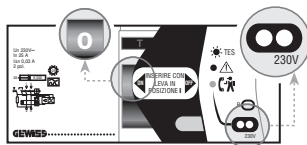

2. Auslösen des FI-Schutzschalters (der Hebel senkt sich und unterbricht die Stromversorgung).

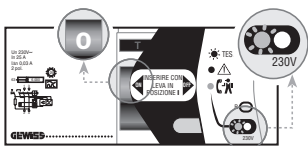

3. Das Gerät führt für min. 20 s eine Überprüfung der Anlage aus (rote Leuchte blinkt). *

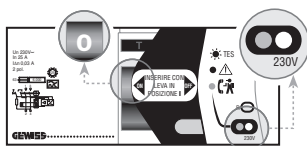

4. Rückstellung wird wegen Probleme der Anlage nicht ausgeführt (Anlage spannungsfrei).

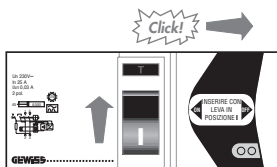

5. Eine manuelle Rückstellung versuchen, indem die Klappe geöffnet und der Hebel angehoben wird.

Falls keine erneute Aktivierung erfolgt, keine weiteren Versuche zur Rückstellung durchführen, sondern einen Elektriker zu Rate ziehen.

GEBRAUCHSANWEISUNG

AUTOMATIKTEST

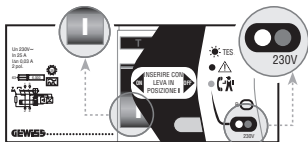

1. Normale Funktion

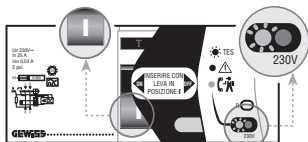

2. Start Test

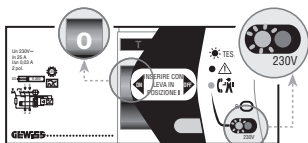

3. Automatische Auslösung des Hebels (Stromversorgung der Anlage wird aufrecht erhalten).

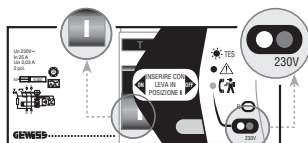

4. Rückstellung ausgeführt (der Hebel kann für die folgenden 3 Minuten nicht von Hand betätigt werden).

SYNCHRONISIERUNG

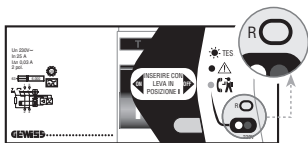

Durch Drücken der Taste R mit einem spitzen Gegenstand (Werkzeug, Kugelschreiber, ...) kann die Selbstdiagnose jederzeit erzwungen werden. Das wöchentliche Programm zur Autodiagnose wird synchronisiert und die Zählung der 7 Tage beginnt mit diesem Moment.

Bei der Ausführung des Autotest-Zyklus kann eine Verzögerung von einigen Minuten auftreten, falls die Taste R nach einer vorhergehenden Rückstellung gedrückt wird.

MANUELLE FUNKTION

VON AUTOMATIK AUF MANUELL



Die Klappe bis zum hörbaren Einrasten verschieben (Anlage mit Strom versorgt).

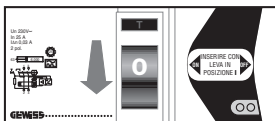

Fall die Stromversorgung der Anlage unterbrochen werden soll, muss der Hebel gesenkt werden.





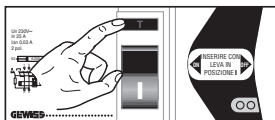











Mit dem Gerät im manuellem Betrieb werden die Funktionen zur Rückstellung und Autodiagnose nicht automatisch ausgeführt.

MONATLICHER TEST DES FI-SCHUTZSCHALTERS

































Bei längerer manueller Verwendung muss die Testtaste monatlich gedrückt werden. Falls der Hebel nicht ausgelöst wird, muss ein Elektriker gerufen werden, um das Gerät zu prüfen.

ANZEIGEN DER LED

LED LINKS	LED RECHTS	GERÄTEFRONT	ZUSTAND	HILFS-KONTAKT
Manuelle Funktion				
			Gerät für Rückstellung und Autodiagnose nicht aktiviert. FI-Schutzschalter geschlossen. Stromversorgung Elektroanlage ein.	
			Gerät für Rückstellung und Autodiagnose nicht aktiviert. FI-Schutzschalter ausgelöst oder absichtlich geschaltet. Stromversorgung Elektroanlage aus.	
 Gelb			Gerät für Rückstellung und Autodiagnose defekt . Sofort einen Elektriker für den Austausch des Geräts rufen. Stromversorgung Elektroanlage aus.*	
 Gelb			Gerät für Rückstellung und Autodiagnose defekt . Sofort einen Elektriker für den Austausch des Geräts rufen. Stromversorgung Elektroanlage ein.	

* Vor der Benachrichtigung eines Elektrikers sollte ein einziges Mal ein manuelles Rückstellen versucht werden.

LED LINKS	LED RECHTS	GERÄTEFRONT	ZUSTAND	HILFS-KONTAKT
Automatikfunktion				
	Grün 			
	Grün 			
Rot 				
Rot 				
Gelb 				
Gelb 	Grün 			

* Vor der Benachrichtigung eines Elektrikers sollte ein einziges Mal ein manuelles Rückstellen versucht werden.

Legende



LED aus



LED ein



LED blinkt



Kontakt geöffnet



Kontakt aktiviert

HINWEISE ZUR INSTALLATION

INSTALLATION

Die Installation des Geräts ist identisch mit der Installation eines normalen FI-Schutzschalters.

Vor dem Anschließen des Schalters sicherstellen, dass die Anlage stromlos ist.

Den Schalter wie in der Abbildung dargestellt anschließen, beachten, dass die Stromversorgung unbedingt von oben erfolgen muss.

ANSCHLUSS

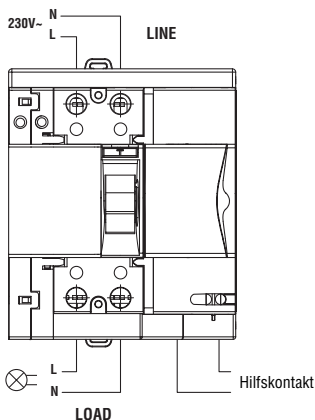

Nach dem Netzanschluss mit der Aktivierung, Überprüfung und Synchronisierung fortfahren.

ÜBERPRÜFUNG

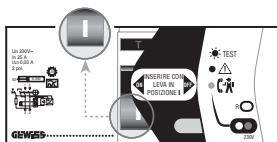

Bei der ersten Inbetriebnahme muss der FI-Schutzschalter mit den entsprechenden Messgeräten zur Anlagenprüfung im automatischen Betrieb zum Auslösen gebracht werden. Falls der Rückstellzyklus nicht korrekt abgeschlossen wird, muss die Isolierung der Anlage zur Erde geprüft werden, die mindestens 500k Ω betragen muss.

KONFIGURATION DES HILFSKONTAKTS

Der Hilfskontakt kann einfach durch Drücken der Taste R für 5 Sekunden für verschiedene Anwendungszwecke konfiguriert werden. Der Wechsel zwischen den verschiedenen Betriebsarten wird durch rotes Blinken der linken LED bestätigt.

- **Status 1: (Voreinstellung) Funktion mit Lätutwerk.**

Bei Verriegelung schaltet der Kontakt NA mit einer Frequenz von 1 Hz für 30 Sekunden und wiederholt die Sequenz stündlich.

Drücken der
Taste R für
5 Sekunden



Lätutwerk

- **Status 2: Funktion mit Wählvorrichtung oder Meldeleuchte.**

Bestätigung der Aktivierung durch doppeltes Blinken. Bei Verriegelung schaltet der Kontakt NA und bleibt bis zum Öffnen der Klappe geschlossen.

Drücken der
Taste R für
5 Sekunden



Relais NC



Wählvorrichtung

- **Status 3: Kommunikation mit der Steuerung ACTIVO.**

Bestätigung der Aktivierung durch dreimaliges Blinken. (für die Verkabelungsschemata wird auf dem Handbuch der Steuerung ACTIVO verwiesen).



Steuerung ACTIVO

Für die Rückkehr zum **Status 1** die Taste R für 5 Sekunden drücken. Bestätigung der Aktivierung durch einmaliges Blinken.

TECHNISCHE EIGENSCHAFTEN

Nennspannung V_n: 230 V Wechselfspannung Phase/Nullleiter TT und TN

Betriebsspannung: von 0,85 bis 1,1 V_n

Aufgenommene Ruheleistung: 8 VA

Aufgenommene Leistung bei Verriegelung: 8 VA

Nennstrom: - 25 A GW 90 901

- 40 A GW 90 902

Maximale Testdauer: 2 Minuten

Isolierspannung für Erde: 2500 V

Empfindlichkeit reiner FI-Schutzschalter: 30 mA

Typ: A

Anzahl DIN-Module: 5

Polanzahl: 2

Umgebungstemperatur: von -5°C bis +40°C

63  6000

Hilfskontakt

- Nennspannung: 230 V Wechselfspannung
- Maximalstrom: 100 mA $\cos \varphi = 1$
- Minimalstrom: 0.6mA
- Klemmenquerschnitt: $\leq 2,5\text{mm}^2$

ABMESSUNGEN

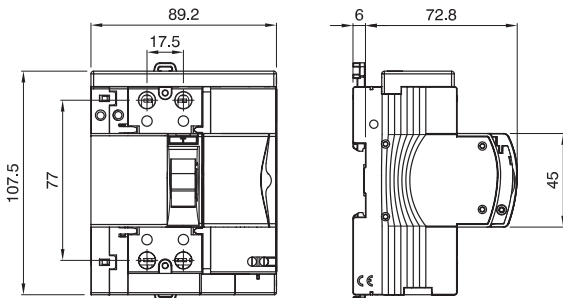

GEWISS

MATERIALE ELETTRICO

SAT



+39 035 946 111

8.30 - 12.30 / 14.00 - 18.00
da lunedì a venerdì



+39 035 946 260

24 ore al giorno



SAT on line
gewiss@gewiss.com