

Product selected: Hi-Spot 95 75W/SP10°

Hi-Spot® 95 mains voltage halogen lamps with E27 cap and aluminium reflector are interchangeable with R95 incandescent reflector lamps. Upgrading to beautiful halogen light could not be quicker or easier. Also available Hi-Spot® 95 Dichroic.

Applications

- For use in mains voltage ES/E27 cap downlights, spotlights and luminaires
- For precision or decorative lighting in retail, commercial and domestic applications
- Use dichroic lamps for lighting food, textiles and other objects sensitive to heat
- Suitable for outdoor use when protected from direct contact with water

Features

- Halogen light without the need for a transformer
- Unique, patented, computer designed spiral faceted aluminised reflector
- Wattages 75W and 100W
- Beam angles 10° and 30°
- Excellent colour rendering
- Can be dimmed using standard dimmer switches
- The use of UV-Stop materials dramatically reduces UV emissions
- Average rated life: 3000 hours

Directions for use

- Dichroic lamps must only be used in fixtures that are designed for use with Cool Beam lamps and which will dissipate the heat radiated from the back of the lamp
- Do not exceed the maximum power rating stated on the fixture
- Do not use the lamp in fittings marked with this label:

Product Attributes

Item description	Hi-Spot 95 75W/SP10°
Ordering Code	0021232
EAN code	5410288212326
Packing Quantity	15
Wattage (W)	75
Voltage (V)	240
Cap	E27
Max. Over. Length (mm)	91
Diameter (mm)	97
Colour Temp (K)	2900
Beam angle(°)	10
Peak intensity (CD)	6900
Average life (hours)	3000

Product Image



UV Stop



Illuminance Diagram

Hi-Spot 95 - 75W/10°

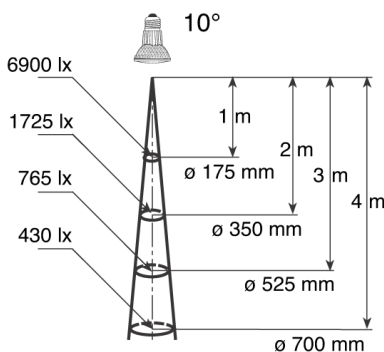

Line Drawing

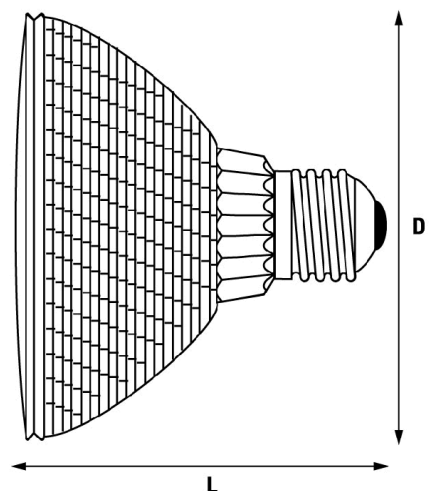

Lamp Cap

E27/ES

