



User Manual



Software Version 1.70-68-18



GLP® JDC1 User Manual – Revision 3.0

This manual covers fixture software version 1.70-68-18

© 2017-2018 German Light Products GmbH. All rights reserved.

The marks 'GLP' and 'German Light Products' are trademarks registered as the property of German Light Products GmbH in Germany, in the United States of America and in other countries.

The information contained in this document is subject to change without notice. German Light Products GmbH and all affiliated companies disclaim liability for any injury, damage, direct or indirect loss, consequential or economic loss or any other loss occasioned by the use of, inability to use or reliance on the information contained in this document.

Head office:

German Light Products GmbH (GLP), Industriestrasse 2, 76307 Karlsbad, Germany
Tel (Germany): +49 7248 92719 - 0

Service & Support EMEA:

GLP, Industriestrasse 2, 76307 Karlsbad, Germany
Tel. (Germany): +49 7248 9271955
Email: support@glp.de
www.glp.de

Service & Support USA:

GLP USA, 1145 Arroyo St., Ste. A, 91340 San Fernando, California
Tel (USA): +1 818 767 8899
Support (US): info@germanlightproducts.com
www.germanlightproducts.com

Table of Contents

| | |
|--|----|
| 1. Safety..... | 5 |
| Key to symbols..... | 5 |
| General safety information | 5 |
| Electrical safety | 6 |
| Fire safety and protection from burns | 7 |
| Eye safety | 7 |
| Strobe safety..... | 8 |
| Installation safety and protection from personal injury..... | 8 |
| 2. Avoiding damage..... | 10 |
| Transportation and storage | 10 |
| 3. Product overview | 11 |
| 4. Features..... | 12 |
| Beam..... | 12 |
| Color Plates..... | 12 |
| DMX control modes..... | 12 |
| Pixel grouping..... | 14 |
| Pixel Orientation | 15 |
| Tilt | 16 |
| Barndoor tilt operation..... | 16 |
| Auto-Blackout..... | 16 |
| Custom settings and factory defaults | 17 |
| Dimming curves | 17 |
| Behavior when a DMX signal is lost | 17 |
| PWM frequency | 17 |
| Effect offsets | 17 |
| Flash control modes | 17 |
| Dimmer flash control mode | 18 |
| FX | 18 |
| Plate color priority | 19 |
| Display..... | 20 |
| Cooling modes..... | 20 |
| Fixture information | 20 |
| Manual control..... | 20 |
| Test sequences..... | 20 |
| Service menu..... | 20 |
| Clamp attachment | 20 |
| 5. Preparation for use | 21 |
| Included items..... | 21 |

| | |
|--|----|
| Mounting | 21 |
| Mounting upright on a level surface | 22 |
| Suspension or horizontal/angled truss mounting..... | 22 |
| Securing with a safety cable | 23 |
| Connecting to power | 23 |
| Installing power connectors..... | 24 |
| Main fuse | 24 |
| Connecting to a DMX control data link | 25 |
| Starting and stopping operation..... | 25 |
| Transportation and Storage | 25 |
| 6. Control menus and LCD display | 26 |
| 7. Control menu layout | 28 |
| 8. DMX channels | 32 |
| DMX Mode 1 (Compressed Pro), 14 DMX Channels | 33 |
| DMX Mode 2 (Normal), 23 DMX Channels | 38 |
| DMX Mode 3 (Single Pixel), 68 DMX Channels..... | 43 |
| DMX Mode 4 (Single Pixel Pro), 62 DMX Channels..... | 49 |
| DMX Mode 5 (Grouped Pixel Pro), 17 DMX Channels..... | 55 |
| 9. Plate FX patterns | 60 |
| 10. Beam FX patterns | 65 |
| 11. Cleaning and maintenance | 68 |
| Suggested maintenance intervals..... | 68 |
| Cleaning..... | 68 |
| GLP Service and Support..... | 68 |
| 12. Technical Specifications | 69 |
| Strobe panel LEDs | 69 |
| Strobe tube LEDs | 69 |
| Movement..... | 69 |
| Connectors | 69 |
| Operating conditions..... | 69 |
| Shipping options..... | 69 |
| Dimensions and weight | 69 |
| 13. Dimensions..... | 70 |

1. Safety

Key to symbols

The following symbols are used in this manual:



Warning! Safety hazard.
Risk of severe injury or death.



Warning! Hazardous voltage.
Risk of lethal or severe electric shock.



Warning! See user manual for important safety information.



Warning! Fire hazard.



Warning! Risk of eye injury.



General safety information

Read this section carefully before installing or using the product. If you have any doubts or questions about how to use the product safely, contact your GLP® supplier for assistance. Your GLP supplier will be happy to help. If necessary, contact an authorized GLP distributor (see list of distributors at www.glp.de).

The JDC1 and this user manual are intended for use by experienced professionals with the knowledge and skills to set up, operate, and maintain high-powered, remotely controlled lighting equipment safely and efficiently. These operations require expertise that may not be provided in this manual.

- Respect all warnings and directions given in this user manual and on the product. Read this manual and familiarize yourself with the safety precautions it contains before installing or using the product. The manufacturer will take no responsibility for damages or harm resulting from disregard for the information in this manual.
- Check the GLP website at www.glp.de and make sure that you have the latest version of this user manual. Check also that the software version indicated on page 2 of the user manual matches the version installed in the product. You can download the correct version of this user manual if necessary.
- Make the user manual available to all installers and operators and save the manual for future reference.
- Use the product only as directed in this user manual. Observe all markings in this user manual and on the product.

- Refer any service operation not described in this manual and refer all repairs to a technician authorized by GLP.
- The light source in this product may not be changed by the end user.
- Read and follow the user documentation for all additional equipment.



Electrical safety

- Do not allow the product to come into contact with water or moisture.
- Use only a source of AC mains power that complies with local building and electrical codes and has both overload and ground fault (earth fault) protection.
- Ensure that the product is electrically connected to ground (earth).
- Disconnect the product from AC mains power before carrying out any installation or maintenance work and when the product is not in use.
- Disconnect the product from power immediately if the power plug or any seal, cover, cable, or other component is damaged, defective, deformed, wet or showing signs of overheating. Do not reapply power until the product has been repaired and made safe by a technician authorized by GLP.
- Before using the product, check that all power distribution equipment and cables are in perfect condition and rated for the electrical requirements of all connected devices.
- Use only Neutrik PowerCON TRUE1 cable connectors for AC mains power input at the product's power connector.
- Use minimum 14 AWG or 1.5 mm² power input and relay cables that are minimum 16 A rated and temperature-rated to suit the application. In the USA and Canada the cables must be UL-listed, type SJT or equivalent. In the EU the cables must be type H05VV-F or equivalent.
- The supplied power input cable is rated as follows:
 - US power cable: 16 A, 14 AWG, UL listed, E304117, SJT, 4.9 ft.
 - EU power cable: 16 A, 1.5 mm², H05VV-F, 1.5 m
- If a fuse blows, replace it with one of the original type and rating only. If new fuses blow, disconnect the product from power and send it to a technician authorized by GLP for repair.



Fire safety and protection from burns

- Do not operate the product if the ambient temperature (T_a) exceeds 45°C (115°F).
- The surface of the product's casing can reach up to 160°C (320°F) during operation. Avoid contact by persons and materials. Do not install the product in a location where there is a risk of accidental contact. Allow the product to cool for at least 20 minutes before handling
- Keep the product well away from flammable materials.
- Keep all combustible materials (e.g. fabric, wood, paper) at least 1 m (3.3 ft.) away from the head.
- Ensure that there is free and unobstructed airflow around the product. Provide a minimum clearance of 100 mm (4 in.) around fans and air vents.
- Do not illuminate surfaces within 1 m (3.3 ft.) of the product. The light output from the product is powerful enough to cause burns or fire in illuminated objects at close range.
- Do not install a fuse that has a higher rating than the one originally installed in the product. Do not bypass fuses.
- Do not stick filters, masks or other materials onto the front glass. Do not block the light output in any way. The front glass becomes extremely hot during operation and can melt or ignite objects that are in contact with the surface. Ensure that the front glass is clean and unobstructed at all times in order to prevent a fire hazard and damage to the product.
- The product's optical components can focus the sun's rays, creating a risk of fire and damage. Do not expose the front of the product to sunlight or any other intense light source, even from an angle.



Eye safety

- The JDC1 is classified as a Risk Group 3 lighting fixture according to EN 62471. Possibly hazardous radiation emitted. Do not stare into the light output from the product. May be harmful to the eyes.
- Do not look at the product's light output with optical instruments or any device that may concentrate the light output.
- Make sure that persons near to or working on the product are not looking directly into the light output when the product lights up suddenly. This can happen when power is applied, when the product receives a DMX signal, or when certain control menu items are selected.

- The warning below is printed on the product. If the warning becomes impossible to read, replace it with a label reproduced from this illustration:

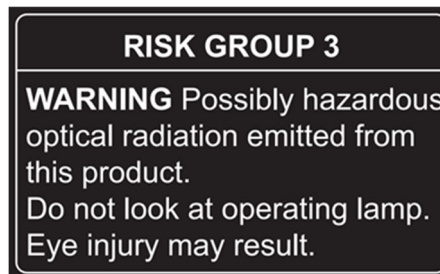

- Provide well-lit conditions to reduce the pupil diameter of anyone working on or near the product.



Strobe safety

- Flashing light, particularly at 5 - 30 Hz, may cause seizures in persons with photosensitive epilepsy. Do not use strobe effects for extended periods.
- Comply with local regulations on the use of strobe lighting and notify the public in advance with highly visible warning signs when strobe effects are used.
- If a seizure occurs, stop using strobe effects. Seek professional medical help. Note the time that the seizure starts and finishes. Call emergency medical help urgently if the seizure lasts more than five minutes, if it is the person's first seizure, or if the person is injured. While waiting for help to arrive, consider the following general advice for caring for a person who is having a seizure: Protect the affected person from injuring themselves on hard or sharp objects. If necessary, move the person to a safe place. Lay them on their side with their head supported to prevent it from hitting the floor. Loosen any tight clothing around their neck. Do not use force to hold the person or restrict their movements. Do not put anything in their mouth, including your fingers.



Installation safety and protection from personal injury

- Installation must be performed by qualified personnel only and carried out in accordance with applicable regulations such as DIN VDE 0711-217.
- The product is not portable when installed.
- Ensure that the supporting structure and installation hardware used can hold at least 10 times the weight of the load that they support.

- Suspend the product with hardware specifically designed and rated for the purpose. Check that the hardware is in perfect condition. Fasteners must be steel grade 8.8 strength or better. Rigging clamps must be half-coupler type that completely encircle the rigging truss chord.
- Screws or bolts used for mounting hardware must protrude minimum 9 mm / 0.36 in. and maximum 11 mm / 0.43 ins. into the threaded holes in the base of the fixture.
- If the product is installed in a location where it may cause injury or damage if it falls, install as directed in this manual a safety cable or similar secondary attachment that will hold the product if a primary attachment fails. The secondary attachment must be approved by an official body such as TÜV as a safety attachment for the weight that it secures, it must comply with EN 60598-2-17 Section 17.6.6, and it must be able to support a static suspended load that is ten times the weight that it secures.
- Fasten the product to a structure or surface as directed in this user manual. Do not use safety cables as the primary means of support.
- Before applying power to the product, ensure that the head can move through its full range without risk of collision.
- Check that all covers and items of rigging hardware are secure before using the product.
- Do not operate the product with missing or damaged covers, shields or any optical component.
- Restrict access below the work area and work from a stable platform whenever installing, servicing or moving the product.
- If the product becomes damaged, stop using it immediately and disconnect it from power. Do not attempt to use a product that is obviously damaged.
- Do not modify the product in any way not described in this user manual.
- Install genuine GLP parts only.

2. Avoiding damage

Do not point the front of the fixture towards the sun or other strong light sources. Strong light can cause internal damage to the fixture, melting components or starting an internal fire within seconds.



Figure 1. Avoiding damage from light sources

Damage can occur whether the fixture is powered on or off. See Figure 1. Damage can also occur if the light hits the front of the fixture at an angle: the fixture does not need to be pointing *directly* at the sun or other light source.

To avoid problems from strong light sources:

- Do not expose the front of the fixture to sunlight or any other strong light source.
- For outdoor applications during daylight, make sure that the front face of the fixture is shielded or points away from the sun, even when not in use.
- Avoid pointing other high-powered beam lights directly at the fixture.

Do not pick up or carry the fixture by the head. The LCD display is also fragile. Picking up or supporting the fixture in these spots could result in damage that is not covered by the warranty.

Use only original spare parts. Do not make any structural modifications to the fixture or you will void the product warranty.

Clean optical components only as directed. Oils, solvents, and other chemicals commonly used for cleaning can damage the lens coatings and surfaces.

Do not drop the fixture or expose it to mechanical stress.

Do not expose the fixture to heat (from other lighting fixtures for example).

Transportation and storage

Transport the fixture either in a flightcase or in its original packaging to protect it from damage caused by shocks during transportation.

Store the fixture in a dry location when not in use.

3. Product overview

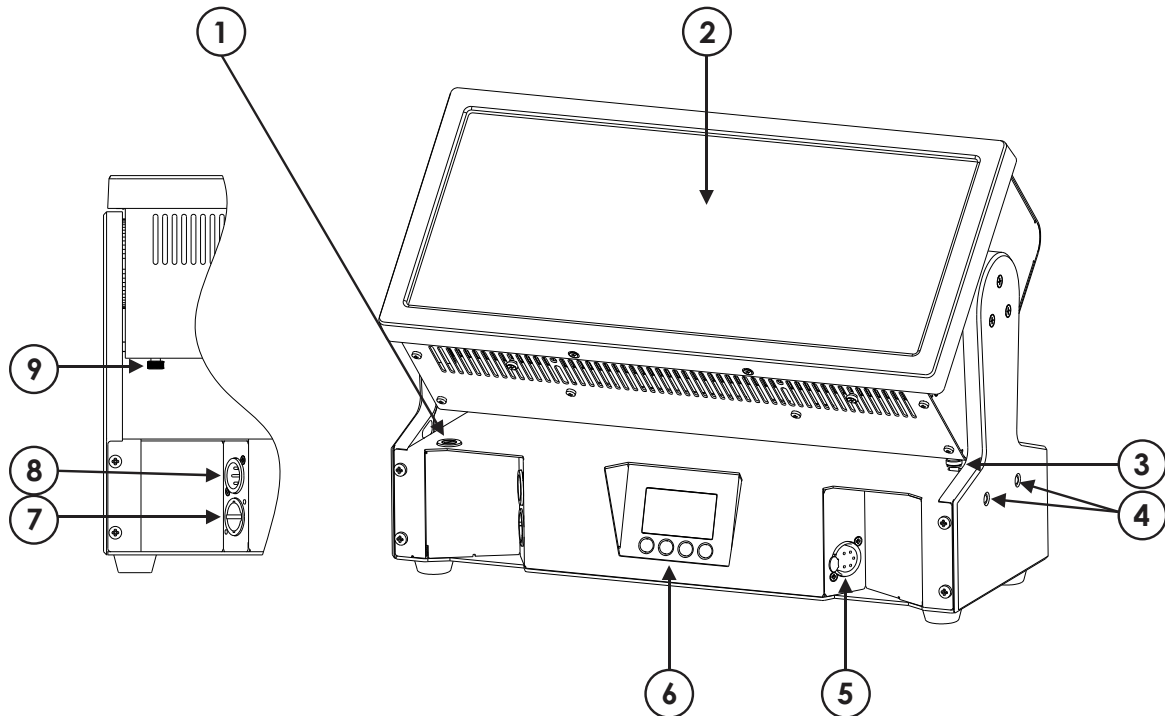

Figure 2. Product overview

- 1 – Fuseholder
- 2 – Head
- 3 – Alignment pin lever
- 4 – Alignment pins
- 5 – DMX thru (out)
- 6 – Control panel
- 7 – AC mains power in (Neutrik powerCON TRUE1)
- 8 – DMX in
- 9 –Tilt lock lever

4. Features

The impression JDC1 from GLP represents a whole new class of moving head combined strobe/color effect lighting fixture. It delivers unprecedented levels of bright, cool white light output combined with a full-face color wash panel that uses 1320 high-quality RGB LEDs. The strobe tube and the color panel can each be split into 12 segments with individual control, and the whole array can be fully pixel mapped through any standard controller. Strobe and color effects can be controlled separately, but they can also be combined for stunning strobe, blinder and wash effects. The JDC1 also features a fast-action moving head with 16-bit control and a 185° tilt range.

The JDC1 is designed for permanent or temporary indoor use. It can be used outdoors if it is protected from moisture and precautions are taken to prevent damage from direct sunlight. It may be placed upright on a level surface or suspended from a suitable structure as described in this manual.

The JDC1 is not suitable for household use, for use in any location where unattended children have access to it, or for use in permanent outdoor installations.

Beam

The JDC1 features a traditional central single-tube element, the Beam, containing 216 cool white LEDs that produce powerful white light.

You can run powerful shutter effects (including a strobe at up to 16.67 Hz) and dynamic FX patterns on the Beam, or you can operate it continuously to give high-output blinder and wash effects with an 86° beam angle. If you set an intensity on the Beam, it will be used as the background intensity if you run a shutter effect or FX pattern on the Beam.

You can control the Beam as one unit or divide it into 12 segments that you can use as separately controllable pixels.

Color Plates

The JDC1 has two RGB color panels – the Plates – on either side of the central Beam tube. Each Plate contains 660 RGB LEDs.

You can run a wide range of color effects including shutter / strobe effects and dynamic FX patterns on the Plates, or you can operate them continuously using RGB color mixing to provide a wide (148°) color wash. If you set a color mix on the Plates, it will be used as the background color if you run a shutter effect or FX pattern on the Plates.

You can control the Plates as one unit or divide them into 12 segments that you can use as separately controllable pixels.

DMX control modes

Five DMX control modes are available in the JDC1. All five modes offer the same functions on DMX channels 1-14. DMX Mode 1 offers the standard functions on channels 1-14 only, while DMX Modes 2-5 offer additional functions using additional DMX channels.

The following DMX modes are available:

- **DMX Mode 1 (Compressed Pro)** uses 14 DMX channels. It gives the following control options that are used as standard in all DMX modes:
 - 16-bit control of tilt, allowing the head to be tilted through 185°, using channels 1 and 2.
 - Beam shutter effects (strobe, ramp up/down etc.) with variable intensity, duration and rate using channels 3-6.
 - Adjustment of a range of fixture settings from the DMX controller using the *Special / Control* commands on channel 7.
 - Plate shutter effects (strobe, ramp up/down etc.) with variable intensity, duration and rate using channels 8-11.
 - RGB color mixing on the Plates using channels 12-14.

- **DMX Mode 2 (Normal)** uses 23 DMX channels. It gives the following control options:
 - Standard control options on DMX channels 1-14.
 - Pre-programmed dynamic FX patterns on the Beam and the Plates, with adjustment of FX speed and of crossfades between the FX and the background using channels 15-19.
 - Master intensity and RGB color mixing on the Plates using channels 20-23.

- **DMX Mode 3 (SPix)** uses 68 DMX channels. It gives the following control options:
 - Standard control options on DMX channels 1-14.
 - Pre-programmed FX patterns using channels 15-19.
 - Master intensity and pixel-level RGB color mixing of Plate pixels 1-12 using channels 20-56.
 - Pixel-level white intensity control of Beam pixels 1-12 using channels 57-68.

For pixel layout in the JDC1, see Figure 4 on page 14.

- **DMX Mode 4 (SPix Pro)** uses 62 DMX channels. It gives the following control options:
 - Standard control options on DMX channels 1-14.
 - Pixel-level RGB color mixing of Plate pixels 1-12 using channels 15-50.
 - Pixel-level white intensity of Beam pixels 1-12 using channels 51-62.

- **DMX Mode 5 (1Pix Pro)** uses 17 DMX channels. It gives the following control options:
 - Standard control options on DMX channels 1-14.
 - Grouped RGB color mixing of the Plates using channels 15-17.

Pixel grouping

The JDC1 gives two LED pixel grouping options, depending on which DMX mode the fixture is in:

- Control of the Beam as one unit and control of both the Plates as one unit (see Figure 3).
- Control of the Beam as 12 separate pixels and control of the Plates as 12 separate pixels (see Figure 4).

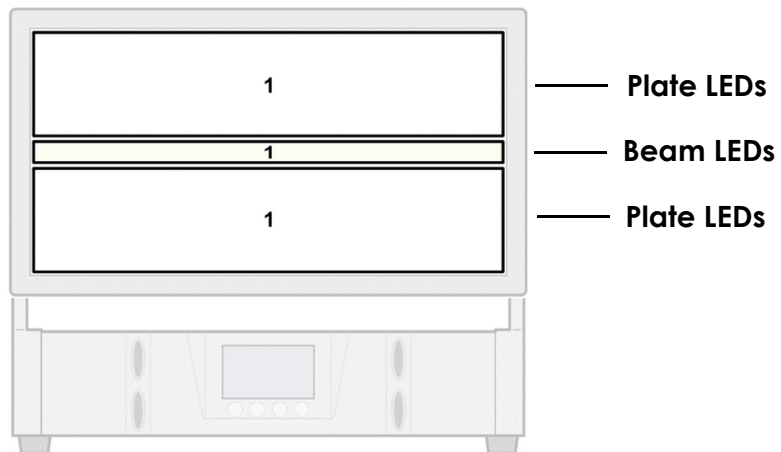
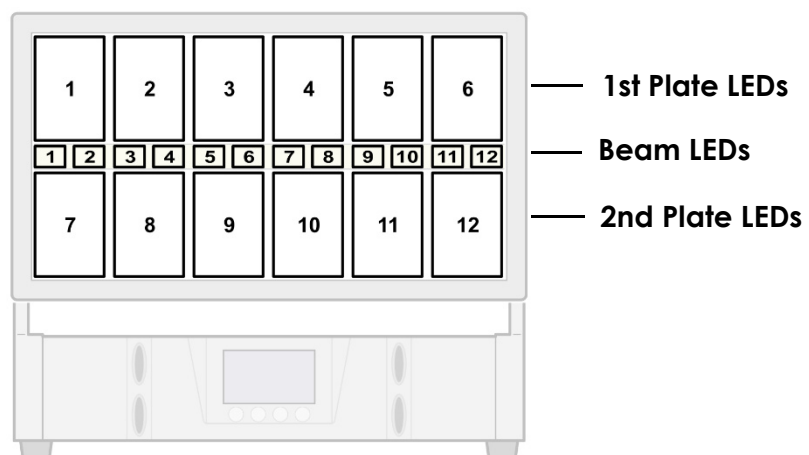

Figure 3: LEDs grouped into Beam and Plate



Pixels are numbered as seen when looking at the front of the fixture with Tilt set to 000.

Figure 4. LEDs grouped into pixels

Pixel Orientation

Figure 4 on the previous page shows the default pixel layout on the Plates. The default pixel orientation setting is:

- Pixel Orientation = **OFF** (Normal)
- 2nd Plate pixel Orientation = **OFF** (Normal).

You can invert pixel orientation by either sending a DMX command on the **Special /Control** DMX channel 7 or using the **Settings** menu in the control panel. Inverting pixels lets you set up symmetrical effects in multiple fixtures quickly without the need to reprogram cues.

See Figure 5. You can invert the order of all the pixels on the Plates and the pixels in the Beam by setting pixel orientation to **ON** (Inverted). Inversion status in the control panel display will change from **NNN** (tilt, pixel orientation and 2nd Plate pixel orientation all Normal) to **NIN** (tilt Normal, pixel orientation Inverted, 2nd Plate pixel orientation Normal) and the pixel layout will be as shown below:

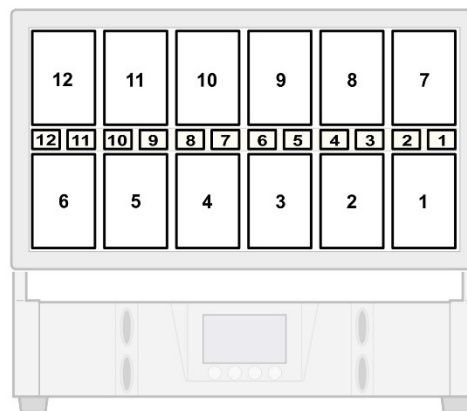

Figure 5. Pixel orientation = ON (Inverted), 2nd Plate pixel orientation = OFF (Normal)

See Figure 6. You can invert the order of the pixels on only the second Plate by setting only 2nd Plate pixel orientation to **ON** (Inverted). Inversion status in the control panel display will be **NNI** and the pixel layout will be as shown below:

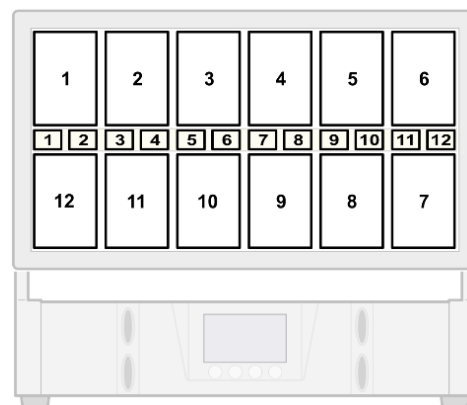

Figure 6. Pixel orientation = OFF (Normal), 2nd Plate pixel orientation = ON (Inverted)

See Figure 7. You can invert the order of all the pixels on the Plate and at the same time invert the order of the pixels on the second Plate by setting Pixel orientation to **ON** (Inverted) and 2nd pixel orientation to **ON** (Inverted). Inversion status in the control panel display will be displayed as **NII** and the pixel layout will be as shown below:

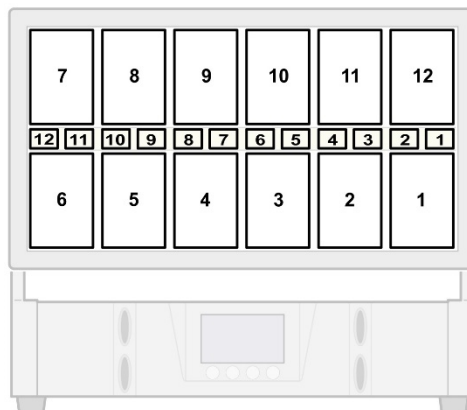

Figure 7. Pixel orientation = ON (Inverted), 2nd Plate pixel orientation = ON (Inverted)

Tilt

The head tilts through 185° with coarse and fine control channels and self-correcting position feedback.

Using the control panel, you can disable tilt position feedback and you can invert tilt direction. Inverting tilt is a fast way of creating symmetrical effects in multiple fixtures. You can also set tilt operation to one of three options:

- Enabled with DMX control.
- Disabled.
- Enabled but without DMX control. In this setting, power is applied to the tilt motor but the fixture will not respond to movement commands sent via DMX. The tilt motor will therefore act as a brake and hold the head in position.

Barndoor tilt operation

If you mount barndoors or any other accessory on the front of the fixture, set **Barndoors** to **ON** either on the Special / Control channel using DMX or in the **Tilt** menu using the control panel. Barndoor tilt operation reduces tilt speed to avoid any damage that could be caused to barndoors, if fitted, by sudden tilt movements.

Auto-Blackout

To avoid any possibility of unexpected behavior from a powerful strobe in the middle of a show or event, you can use the **Shutter** menu in the control panel to set the fixture to black out automatically if it detects an internal error. If this happens, the error will be listed in **Information – System Errors** in the control panel.

You can also set the fixture to black out automatically if more than three seconds passes without the fixture receiving a valid DMX signal.

Custom settings and factory defaults

The **Init Positions** menu in the control panel lets you replace the fixture's factory default settings with any custom settings (DMX Mode, pixel orientation, etc.) that you have stored using the control panel or via DMX. If you apply an **Init Positions – Save** command, the fixture will return to these custom settings after a power off/on cycle or after a reset.

You can delete all saved custom settings at once and return to the factory default settings using an **Init Positions – Reset** command.

Dimming curves

See illustration on right. Three dimming curves are available: **Linear**, **Soft**, and **Extra soft**. You can select a curve using the control panel or using the Special / Control DMX channel.

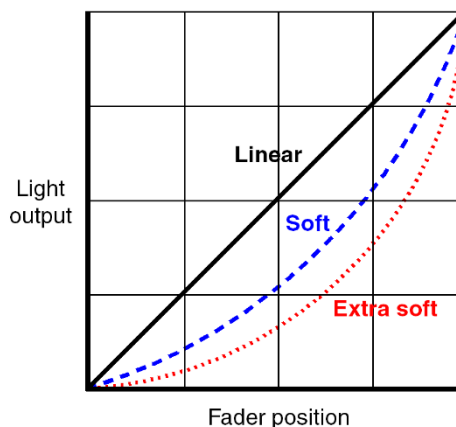

Behavior when a DMX signal is lost

You can choose how the fixture behaves if it is receiving a DMX signal but the signal stops. Three options are available in the **DMX Hold** menu in the control panel: the fixture can:

- black out immediately,
- fade down to a blackout, or
- continue obeying the last DMX command it received.

PWM frequency

You can adjust the PWM frequency of the LEDs from 582 to 618 Hz in 1 Hz increments, or you can set the PWM frequency to 1200 or 2400 Hz.

Effect offsets

Effect offsets are a fast way to set up effect chases in multiple fixtures. You can set effect offsets with starting points in the effect cycle from 10° to 360° in 10° increments.

You can set an offset for the Beam on channel 7 and set an offset for the Plates on channel 11 in all DMX modes.

Any offset that you set will apply to the standard shutter effects available in all DMX modes and also the FX patterns available in DMX Modes 2 and 3.

Flash control modes

The JDC1 offers three flash control modes that can be selected either in the control menus or via DMX on the Special / Control channel:

In **Normal** flash control mode, you set the rate and duration of Beam and Plate flashes on their respective rate and duration channels. If you increase the flash rate, the duration of flashes will not change but the intervals between flashes will become shorter. **Normal** flash control mode gives you full control over flash duration, but it means that you may need to adjust flash duration if you change the flash rate.

In **Percentage** flash control mode, you set the duration of Beam and Plate flashes on their respective duration channels as a percentage of the flash on/off cycle. Once you have set this percentage, flash duration is automatically adjusted to match flash rate. If you increase the flash rate, the duration of flashes will be reduced. **Percentage** flash control mode makes it easy to control flashes using the rate channel only.

In **Aggressive** flash control mode, flash rate and duration are controlled as in Normal flash mode, but if intensity on the Plates is below 100%, the extra available power is pushed to the Beam LEDs. This gives an even more powerful Beam flash than in the other flash modes.

If Plate LEDs are at zero intensity, enabling Aggressive flash mode will give maximum Beam flash intensity. If you increase Plate intensity, Beam and Plate output will be balanced to give the best performance. If you set Plate intensity to maximum, Beam intensity will be the same as in Normal flash mode.

Flash Modes can be changed very quickly (hold for 0.5 seconds) by programming the setting in the cue directly. This means that it is possible to swap between flash modes in the middle of a show.

Dimmer flash control mode

Producing single flashes is quick and easy if you activate **Dimmer Flash** mode in the **Settings** control menu. Activating this mode affects both the Beam and the Plates.

With Dimmer flash mode enabled, if the Shutter channel (6 for the Beam and 10 for the Plates) is set to zero, any new DMX value that you input on the Intensity channel (3 for the Beam and 8 for the Plates) will produce a single flash on the Beam or Plates. In effect, all you need to do is 'nudge the dimmer fader' to produce a flash.

FX

DMX Modes 2 and 3 include pre-programmed FX on channels 15-19. The FX are dynamic patterns that are superimposed onto the Beam and/or the Plate LEDs. Normally, all the Beam or all the Plate pixels flash at the same time. But when you select an FX, only the pattern pixels flash.

The following control options are available via DMX when using FX:

- Select FX pattern and speed for the Beam
- Select FX pattern and speed for the Plates
- Adjust crossfade time (fade time between FX pattern and background).

For tables showing all the patterns available on the Beam and the Plates, see pages 60 and 65.

Plate color priority

The JDC1 lets you set an RGB color for strobe flashes and FX patterns that are superimposed on the Plates as well as setting an RGB color for the background on the Plates. You can choose from three options that define how strobe flash and FX pattern colors are superimposed over background colors using the settings available via DMX on channel 7:

- **FX Pattern Priority:** A strobe flash or FX pattern on the Plates will always use the FX/flash color and override the plate background color.

For example, if you have created a 100% intensity red FX or flash and a 50% intensity green background, the FX or flash will always be visible as 100% intensity red over a 50% intensity green background.

- **Color Mix:** A strobe flash or FX pattern on the Plates will mix with the plate background color using additive color mixing. The color of the FX pattern or flash will change if you adjust the FX pattern / flash color, and it will also change if you adjust the plate background color.

For example, if you have created a 100% intensity red FX or flash and a 50% intensity green background, the FX or flash will appear as 100% intensity yellow over a 50% intensity green background.

- **Background Color:** An FX pattern or flash on the Plates will only be visible if no background color is set on the Plates. If a background color is set on the Plates, the FX pattern or flash will use the plate background color.

For example, if the fixture is in **Background Color** mode and you have:

- created a 100% intensity red FX or flash, and
- created a 50% intensity green background,

then the FX or flash will be not visible: you will only see the 50% intensity green background. However, if you dim the background intensity down to zero, you will see the 100% intensity red FX pattern or flash.

The Plate Color Priority settings can help you set up interesting effects when the Plates are controlled as one pixel, but they can give even richer, more complex effects when the Plates are controlled as twelve separate pixels. In **Color Mix** and **Background Color** modes, setting different Plate pixels to different colors and intensities will affect the appearance of any FX patterns or flashes that are superimposed on those pixels.

For example, if the fixture is in **Background Color** mode and you have:

- created a 100% intensity red FX or flash,
- set even-numbered pixels (2, 4, 6, etc.) to zero intensity, and
- created a 50% intensity green background on odd-numbered pixels,

then the FX or flash will only be visible on the even-numbered pixels. On the odd-numbered pixels you will only see the 50% intensity green background.

Display

The illuminated graphic LCD display with self-charging battery lets you change fixture settings even when the power is off. See Chapter 6 for settings, readouts, and related information.

You can adjust the contrast and brightness of the display in the **Display** menu in the control panel. You can also invert the display for easier reading if the fixture is flown head-down in a rig, and you can set the display to flash if the DMX signal to the fixture is lost, giving a discreet indication of DMX signal status.

Cooling modes

Cooling fans can be set to one of two modes:

- **Auto** for temperature-regulated operation. This mode optimizes cooling for quietness.
- **High** for constant high-speed operation. This mode minimizes the possibility that the fixture will reduce its light output if it exceeds thermal safety limits. This will normally only happen when the fixture is worked hard for extended periods in high ambient temperatures.

Fixture information

The **Information** menu in the control panel gives access to a long list of information items. You can see a list of any internal errors that the fixture may have detected, check main and distributed software and hardware versions, check temperature sensor readouts, see logs of operating hours and boot count and check whether the fixture is running on AC mains or battery power.

You can monitor the DMX values being received on the main DMX channels, and you can monitor cooling fan operation.

Manual control

The **Manual Control** menu in the control panel lets you reset the entire fixture, reset tilt only, or reset left or right LED drivers only. It also lets you control the main functions of the fixture without DMX.

Test sequences

The **Test** menu lets you run test sequences to ensure correct operation of Tilt movement only, color output from the RGB LEDs on the Plates only, or the entire fixture.

Service menu

The **Service** menu is password-protected and is intended for use by GLP Service.

Clamp attachment

The base provides Camlock attachment points for easy fastening of an omega clamp attachment bracket that accepts two half-coupler clamps.

5. Preparation for use



Warning! Read 'Safety' starting on page 5 for important safety information that you must understand before you install or operate the fixture.

Included items

The JDC1 is supplied with a power cord with Neutrik powerCON TRUE1 connector and an omega bracket (Part No. 87036) that lets you fasten two half-coupler rigging clamps to the fixture.

Mounting

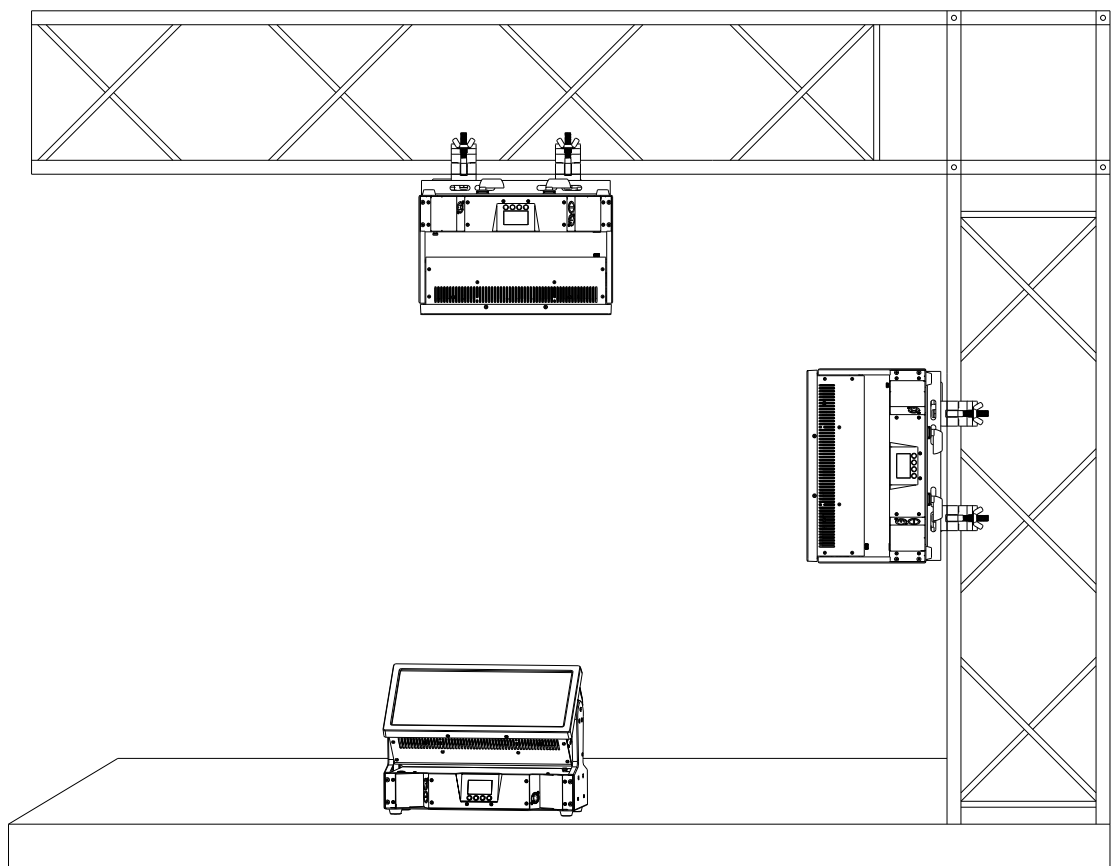

Figure 8: Mounting options (safety cable not shown)

The JDC1 may be rigged in any orientation or placed on a level surface. When installing, keep the head at least 1 m (3.3 ft.) from flammable materials including curtains and stage scenery.

Mounting upright on a level surface

The JDC1 may be placed upright on a level surface. Make sure that persons cannot accidentally touch the fixture when it is installed.

See illustration on right. You can align fixtures side by side by inserting the alignment pins (arrowed) on the right-hand side of one fixture into the holes on the left-hand side of the next fixture.

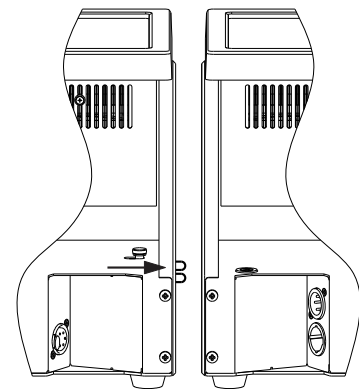

Figure 9: Alignment pins

Suspension or horizontal/angled truss mounting

You can fasten the JDC1 to a rigging truss with the head hanging vertically downwards, or you can fasten the JDC1 to a truss horizontally or at any angle. To fasten to a truss:

1. Bolt two suitable half-coupler rigging clamps to the supplied omega clamp attachment bracket.

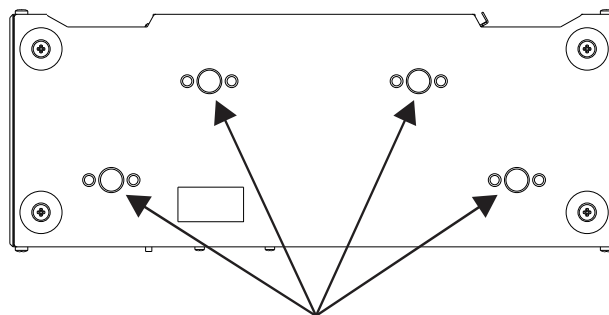

Figure 10: Camlock sockets

2. See illustration above. Fasten the omega bracket to the base of the fixture with four Camlock quarter-turn fasteners by lining up the pins in the fasteners with the keyways in the sockets, inserting the pins into the sockets and turning a full 90° clockwise to lock them.
3. Fasten the rigging clamps securely around a chord on a rigging truss or similar bar. Secure as directed below.

Securing with a safety cable

If the fixture can cause injury or damage if it falls, secure it with a secondary attachment such as a safety cable that is approved for the weight of the fixture as soon as you have fastened it in position.

To secure the fixture:

1. See illustration below. Attach a safety cable to the safety cable attachment point in the fixture base and loop it around the truss chord or bar so that it will hold the fixture if one or both of the rigging clamps fail. Take up as much slack as possible in the safety cable (by looping it more than once around a truss chord, for example).

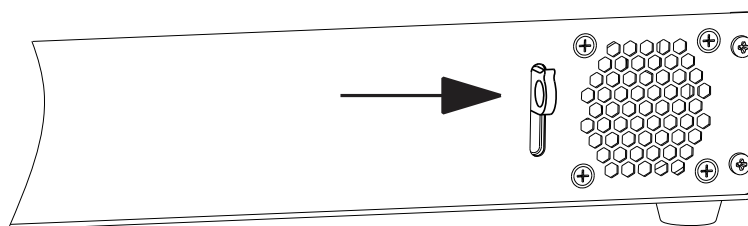

Figure 5: Safety cable attachment point

2. Make sure that the fixture is secure and that the head will not collide with any objects when it tilts.

Connecting to power

The AC mains power supply must include a connection to ground / protective earth. It must be protected against ground / earth leakage and overload. The autosensing power supply accepts AC power at 100-240 V, 50/60 Hz. Do not connect the fixture to power at any other voltage or to an external dimmer.

The JDC1 does not have a power ON/OFF switch. Power is applied to the fixture as soon as the power cable becomes live.

The JDC1 has a 3-conductor Neutrik powerCON TRUE1 socket that accepts AC power from a TRUE1 female cable connector. Although TRUE1 connectors support hot-plugging, it is still good practice to shut down power to power cables or move Power ON/OFF switches to OFF before connecting power cables to fixtures.

To connect the fixture to power:

1. If possible, shut down power to the power input cable.
2. See Figure 2 on page 11. The Neutrik powerCON TRUE1 AC mains power input socket is located on the base of the fixture. Note the position of the keys and keyways on the TRUE1 connectors. Line them up carefully, then connect the power input cable to the power input socket by inserting the cable connector and twisting clockwise to lock.

3. Check that the head is unlocked and can move freely and check that nobody is looking directly into the front of the fixture. Apply power to the fixture by energizing the power cable.

To disconnect the power cable, pull the latch on the cable connector outwards to release it, then twist the connector counterclockwise and remove it from the socket.

Installing power connectors

It is possible to install a cord cap / mains power plug that is suitable for your local convenience receptacles / mains power sockets on the supplied power input cable. If you do this, check that the cord cap / plug is rated minimum 250 V, 16 A, that it has a connection to ground / earth and that it has an integral cable grip. Follow the cord cap / plug manufacturer's assembly instructions.

If you need to install a Neutrik powerCON TRUE1 connector on a power cable, follow the instructions given in the Support area of the Neutrik website at www.neutrik.com.

Respect the color coding used in the supplied power cable and in your local mains power wiring system. US and EU systems use the color coding shown below:

| | Live or L | Neutral or N | Ground / Earth or ⊕ |
|------------------|-----------|--------------|---------------------|
| US system | Black | White | Green |
| EU system | Brown | Blue | Yellow/green |

Main fuse

See Figure 2 on page 11. The main fuse sits in a holder in the base.

If the fixture appears to be completely shut down even though power is applied, the main fuse may have blown. Disconnect the fixture from power before replacing the fuse. Replace only with a fuse of the same type and rating.

Connecting to a DMX control data link

The JDC1 provides 5-pin XLR IN and THRU sockets for connection to a USITT DMX512 data link.

Connectors use standard DMX pinout:

- Pin 1 = Ground
- Pin 2 = Negative / data cold
- Pin 3 = Positive / data hot.
- Pins 4 and 5 are not used.

If you would like any advice with planning and installing a DMX link, your GLP supplier will be happy to provide assistance.

Starting and stopping operation



Warning! Before you apply power to the fixture or operate it after a blackout, make sure that nobody is looking directly into the front glass from close to the fixture.

Check that the tilt lock has been released before operating the fixture.

The JDC1's TRUE1 AC mains power input connector supports hot-plugging, and it can be quickest to disconnect a live power cable if you need to shut down power urgently, but it may still be wise to show caution and connect and disconnect power cables without power applied. Apply power to the AC mains circuit to start operation. Shut down power to the AC mains circuit to stop operation.

Transportation and Storage

We strongly recommend that you transport the JDC1 either in a flightcase or in its original packaging to protect it from damage caused by shocks during transportation. Lock the head in the horizontal position for transport by sliding the tilt lock lever to the locked position. The position of the tilt lock lever is shown in Figure 2 on page 11.

When the fixture is not installed, disconnect it from power and store it in a dry location.

6. Control menus and LCD display



Warning! DMX control is disabled when the control menus are active. Be prepared for the head to tilt and for the fixture to emit strong light as soon as you exit the control menus.

The control panel and LCD display provide access to user settings, readouts and utilities, including manual control and a test routine.

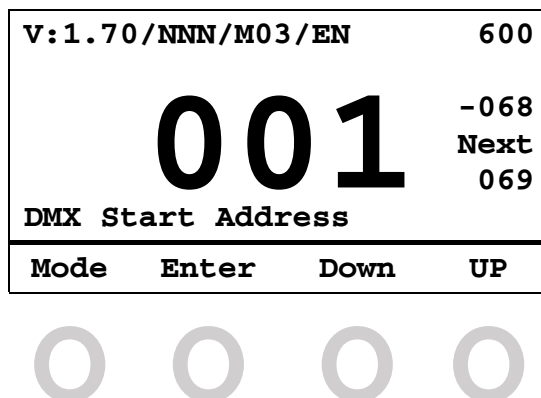

Figure 11. Main menu

See Figure 11. From left to right, the top line of the main menu displays:

- Main CPU software version
- DMX control modes for tilt, all pixels orientation and Plate 2 pixels orientation: N(ormal) or I(nverted)
- DMX mode number
- Dimming mode: L(inear), S(off), or E(xtra Soft)
- Flash mode: N(ormal) or (P)ercentage
- PWM frequency in Hz

For example, if the top line reads “**V:1.70/NNN/M03/EN/600**”, then:

- The main CPU software is version **1.70**,
- DMX control of tilt is set to **Normal**, Plate pixels orientation is set to **Normal**, and 2nd Plate pixels orientation is set to **Normal**,
- DMX mode 3 (**M03**) is selected,
- Dimming mode is set to **Extra soft**,
- Flash mode is set to **Normal**, and
- PWM frequency is set to **600** Hz.

The fixture also displays its DMX start address and indicates which DMX channels it uses and which DMX channel is available as the start address for the next fixture on the DMX link.

When the fixture boots up, the panel displays fixture information including component firmware and hardware versions and fixture hours before displaying the PCB reset status screen. After resetting, the panel displays the main menu.

The bottom row of the display shows the functions of the four control buttons. Press the **Mode** button to escape and return to the top of the menu. Press the **Enter** button to select a setting, issue a command, or enter a submenu. Press the **Down** and **Up** buttons to scroll through menu options.

To return resettable counters to zero, press and hold **Enter** for 3 seconds with the counter displayed.

DMX control is disabled when the control menus are active.

A flashing display indicates loss of DMX.

7. Control menu layout

| Menu Selection | | Value | Remarks |
|--------------------------|--|-----------------------|--|
| DMX Start Address | | 1-512 | Set the DMX start address |
| Setup | | | |
| DMX Mode | | | |
| M01 COMPRESS | | - | Compressed 14-channel mode |
| M02 NORMAL | | - | Normal 23-channel mode |
| M03 SPIX | | - | High resolution 68-channel mode |
| M04 SPIXPRO | | - | High resolution 62-channel mode |
| M05 1PIXPRO | | - | Low resolution 17-channel mode |
| Settings | | | |
| Tilt | | | |
| Invert Tilt | | ON/OFF | Invert tilt control |
| Reset Tilt | | ON/OFF | If set to OFF, tilt movement will not reset if fixture resets |
| Position Feedback | | ON/OFF | Enable/disable tilt position feedback |
| Barndoor | | ON/OFF | Reduces tilt speed to protect barndoors etc. |
| Tilt Enable | | ON | Tilt enabled and DMX controllable |
| | | OFF | Tilt disabled |
| | | NC | Tilt enabled, not DMX controllable |
| Shutter | | | |
| Error Blackout | | ON/OFF | Blackout if internal error detected |
| No DMX Blackout | | ON/OFF | Blackout if no DMX for 3 seconds |
| Init Positions | | | |
| Save | | - | Save as initial positions |
| Reset | | - | Restore default positions |
| Dimming Curve | | | |
| Linear | | - | Select dimming curve |
| Soft | | - | |
| Extra Soft | | - | |
| DMX Hold | | | Behavior if no DMX signal received |
| Off | | - | Blackout on loss of DMX |
| Fade Out | | - | Fade out on loss of DMX |
| Hold | | - | Hold state on loss of DMX |
| PWM Frequency | | | Adjust PWM frequency for all LEDs |
| 582-618 Hz | | - | Default = 600 Hz |
| 1200 Hz | | - | |
| 2400 Hz | | - | |
| Pixel Orientation | | INVRS/ NORM | Numbering of all plate and all beam pixels (OFF = normal, ON = inverted) |
| Second Pixel Orientation | | INVRS/ NORM | Numbering of plate pixels 7-12 only (OFF = normal, ON = inverted) |

| | | | |
|-------------|------------------------|---------------------|--|
| | Flash Mode | PCT | Percentage flash mode |
| | | NORM | Normal flash mode |
| | | AGGER | Aggressive flash mode |
| | Dimmer Flash | ON/OFF | Dimmer Flash mode |
| | Plate Color Priority | Strobe Color | FX patterns and flashes use Plate FX/flash color |
| | | Color Mix | FX patterns and flashes use mix of Plate FX/flash color and background color if a background color is active |
| | | Back-ground color | FX patterns and flashes uses Plate background color if a background color is active |
| | Display | | Adjust control panel display |
| | Contrast | 0-100% | Default = 50% |
| | Brightness | 0-100% | Default = 100% |
| | Blackout Time | 1-30 s | Display sleep (seconds after last keypress) Default = 10 s |
| | Display Orientation | Normal | Normal display |
| | | Inverted | Inverted display |
| | No DMX Flash | ON/OFF | Display flashes if loss of DMX |
| | Temperature Unit | °C/°F | |
| | Fan Mode | | |
| | Auto | - | Temperature-controlled fan speed |
| | High | - | Maximum cooling |
| | Reset Factory Settings | Yes/No | Reset all values except serial number |
| Information | | | |
| | System Errors | List | Display recent errors |
| | System Versions | | |
| | Main | SW/HW | Display software and hardware versions in the fixture's modules |
| | Tilt | SW/HW | |
| | NM-LED A | SW/HW | |
| | NM-LED B | SW/HW | |
| | NM-LED C | SW/HW | |
| | NM-LED D | SW/HW | |
| | Temperatures | | |
| | Main Temperature | | |
| | Current | °C/°F | Current base temperature |
| | Max. Resettable | °C/°F | Max. temperature since last reset |
| | Max. Non-resettable | °C/°F | All time maximum temperature |
| | LED Temperature | | |
| | Current | °C/°F | Current LED temperature |
| | Max. Resettable | °C/°F | Max. LED temperature since last reset |
| | Max. Non-resettable | °C/°F | All time maximum LED temperature |
| | Fixture Information | | |
| | Fixture Hours | | |
| | Total hours | hours | Total hours of operation |
| | Resettable hours | hours | Hours of operation since last reset |
| | Boot Count | count | Total number of power-ons |

| | | | |
|-------------------|------------------------|--------|--|
| Fixture Status | | | |
| | Power State | BAT/PO | Fixture on battery or AC mains power |
| DMX Input Monitor | | | |
| | Tilt | 0-255 | Shows current DMX values for each effect |
| | Special / Control | 0-255 | |
| | Beam FX Shutter | 0-255 | |
| | Beam Dimmer | 0-255 | |
| | Beam Duration | 0-255 | |
| | Beam Rate | 0-255 | |
| | Color Shutter | 0-255 | |
| | FX Color Dimmer | 0-255 | |
| | Color Duration | 0-255 | |
| | Color Rate | 0-255 | |
| | Plate Red | 0-255 | |
| | Plate Green | 0-255 | |
| | Plate Blue | 0-255 | |
| | FX Crossfade | 0-255 | |
| | Pattern Color Movement | 0-255 | |
| | Pattern Select Color | 0-255 | |
| | Pattern Beam Movement | 0-255 | |
| | Pattern Select Beam | 0-255 | |
| | Master Pix Intensity | 0-255 | |
| Fans Monitor | | | |
| | PSU Fan | RPM/V | Shows fan speed and voltage |
| | Head Fan | RPM/V | |
| Manual Control | | | |
| Reset | | | |
| | Full System Reset | YES/NO | Reset options |
| | Tilt Reset | YES/NO | |
| | NM_LED L Driver | YES/NO | |
| | NM_LED R Driver | YES/NO | |
| Manual DMX | | | |
| | Tilt | 0-255 | Enter control values to control each effect (new values received via DMX override manually entered values) |
| | Special / Control | 0-255 | |
| | Beam FX Shutter | 0-255 | |
| | Beam Dimmer | 0-255 | |
| | Beam Duration | 0-255 | |
| | Beam Rate | 0-255 | |
| | Color Shutter | 0-255 | |
| | Color Dimmer | 0-255 | |
| | Color Duration | 0-255 | |
| | Color Rate | 0-255 | |
| | FX Color Dimmer | 0-255 | |
| | Plate Red | 0-255 | |
| | Plate Green | 0-255 | |
| | Plate Blue | 0-255 | |
| | FX Crossfade | 0-255 | |
| | Pattern Color Movement | 0-255 | |

| | | | |
|---------|--------------------------|--------|--|
| | Pattern Select Color | 0-255 | Enter control values to control each effect (new values received via DMX override manually entered values) |
| | Pattern Beam Movement | 0-255 | |
| | Pattern Select Beam | 0-255 | |
| | Master Pix Intensity | 0-255 | |
| | Reset All Values | YES/NO | |
| Test | | | |
| | Tilt | ON/OFF | Run test of functions |
| | Color | ON/OFF | |
| | All | ON/OFF | |
| Service | Reserved for GLP Service | | |

Table 1 Control Menus

Default settings are written in **BOLD type**.

8. DMX channels

The JDC1 can be operated in five different DMX modes that use from 14 to 68 channels. The commands for each mode are listed in the following tables.

The layout of channels 1-14 is the same in each mode.

Where commands are marked with an asterisk * you must start from DMX value zero and then send the DMX value continuously for 3 seconds (unless a different duration is stated) to apply the command.

DMX Mode 1 (Compressed Pro), 14 DMX Channels

Tilt, Beam shutter, special/control, Plates shutter, Plates grouped RGB

| Channel | Command | DMX range | Percent | Default DMX | Fade | |
|-------------------------------|--------------------------|--|---------|-------------|------|------|
| 1 | Coarse Tilt (MSB) | 0-185° | 0-255 | 0-100% | 127 | Fade |
| 2 | Fine Tilt (LSB) | Coarse tilt + 0-1.2° | 0-255 | 0-100% | 127 | Fade |
| 3 | Beam Intensity | Intensity 0-100% | 0-255 | 0-100% | 0 | Fade |
| 4 | Beam Duration | Flash duration 7-650 ms | 0-255 | 0-100% | 255 | Fade |
| 5 | Beam Rate | Flash rate 0.289-16.67 Hz | 0-255 | 0-100% | 255 | Fade |
| 6 | Beam Shutter | No effect | 0-36 | 0-14.0% | 0 | Snap |
| | | Ramp up (= fade on, snap off) | 37-40 | 14.5-15.5% | | |
| | | Ramp up random | 41-44 | 16.0-17.0% | | |
| | | Ramp down | 45-48 | 17.5-18.5% | | |
| | | Ramp down random | 49-52 | 19.0-20.0% | | |
| | | Ramp up down | 53-56 | 20.5-21.5% | | |
| | | Ramp up down random | 57-60 | 22.0-23.0% | | |
| | | Random white beam | 61-64 | 23.5-24.5% | | |
| | | Random single pixel of white beam | 65-68 | 25.0-26.0% | | |
| | | Lightning | 69-72 | 26.5-27.5% | | |
| | | Spikes (flash over low light) | 73-76 | 28.0-29.0% | | |
| | | White beam, left to right | 77-80 | 30.0-31.5% | | |
| | | White beam, left to right, random | 81-84 | 32.0-33.0% | | |
| | | White beam, right to left | 85-88 | 33.5-34.5% | | |
| | | White beam, right to left, random | 89-92 | 35.0-36.0% | | |
| | | White beam, left to right, bounce | 93-96 | 36.5-37.5% | | |
| | | White beam, left to right, bounce, random | 97-100 | 38.0-39.0% | | |
| | | White beam, right to left, bounce | 101-104 | 39.5-40.5% | | |
| | | White beam, right to left, bounce, random | 105-108 | 41.0-42.5% | | |
| | | Zig, 6 steps, outer to center pixels | 109-112 | 43.0-43.5% | | |
| | | Zig, 6 steps, outer to center pixels random | 113-116 | 44.0-45.5% | | |
| | | Zag, 6 steps, center to outer pixels | 117-120 | 46.0-47.0% | | |
| | | Zag, 6 steps, center to outer pixels, random | 121-124 | 47.5-48.5% | | |
| | | Zigzag, 10 steps | 125-128 | 49.0-50.0% | | |
| | | Zigzag, 10 steps, random | 129-132 | 50.5-52.0% | | |
| | | No function | 133-179 | 52.5-70.0% | | |
| | | Double flash | 180-183 | 70.6-71.8% | | |
| | | Double flash, random | 184-187 | 72.2-73.3% | | |
| | | Double flash, b-c (beam-color) | 188-191 | 73.7-74.9% | | |
| | | Double flash, b-c, random | 192-195 | 75.3-76.5% | | |
| | | Double flash, c-b (color-beam) | 196-199 | 76.9-78.0% | | |
| | | Double flash, c-b, random | 200-203 | 78.4-79.6% | | |
| Triple flash | 204-207 | 80.0-81.2% | | | | |
| Triple flash, random | 208-211 | 81.6-82.7% | | | | |
| Triple flash, beam-color-beam | 212-215 | 83.1-84.3% | | | | |
| Triple flash, b-c-b, random | 216-219 | 84.7-85.9% | | | | |
| Triple flash, c-b-c | 220-223 | 86.3-87.5% | | | | |
| Triple flash, c-b-c, random | 224-227 | 87.8-89.0% | | | | |

| | | | | | | |
|-------------|-----------------------------|--|---------|------------|---|------|
| 6 | Beam Shutter (continued) | Quad flash | 228-231 | 89.4-90.6% | | |
| | | Quad flash, random | 232-235 | 91.0-92.2% | | |
| | | Quad flash, b-c-b-c | 236-239 | 92.5-93.7% | | |
| | | Quad flash, b-c-b-c, random | 240-243 | 94.1-95.3% | | |
| | | Quad flash, c-b-c-b | 244-247 | 95.7-96.9% | | |
| | | Quad flash, c-b-c-b, random | 248-251 | 97.3-98.4% | | |
| | | No function | 252-255 | 98.5-100% | | |
| 7 | Special / Control | No function | 0 | 0% | 0 | Snap |
| | | Beam Shutter effects and FX patterns offset: | | | | |
| | | 10° | 1 | 0.4% | | |
| | | 20° | 2 | 0.8% | | |
| | | 30° | 3 | 1.2% | | |
| | | 40° | 4 | 1.6% | | |
| | | 50° | 5 | 2.0% | | |
| | | 60° | 6 | 2.4% | | |
| | | 70° | 7 | 2.8% | | |
| | | 80° | 8 | 3.1% | | |
| | | 90° | 9 | 3.5% | | |
| | | 100° | 10 | 3.9% | | |
| | | 110° | 11 | 4.3% | | |
| | | 120° | 12 | 4.7% | | |
| | | 130° | 13 | 5.1% | | |
| | | 140° | 14 | 5.5% | | |
| | | 150° | 15 | 5.9% | | |
| | | 160° | 16 | 6.3% | | |
| | | 170° | 17 | 6.7% | | |
| | | 180° | 18 | 7.1% | | |
| | | 190° | 19 | 7.5% | | |
| | | 200° | 20 | 7.8% | | |
| | | 210° | 21 | 8.2% | | |
| | | 220° | 22 | 8.6% | | |
| | | 230° | 23 | 9.0% | | |
| | | 240° | 24 | 9.4% | | |
| | | 250° | 25 | 9.8% | | |
| | | 260° | 26 | 10.2% | | |
| | | 270° | 27 | 10.6% | | |
| | | 280° | 28 | 11.0% | | |
| | | 290° | 29 | 11.4% | | |
| | | 300° | 30 | 11.8% | | |
| | | 310° | 31 | 12.2% | | |
| | | 320° | 32 | 12.6% | | |
| | | 330° | 33 | 12.9% | | |
| | | 340° | 34 | 13.3% | | |
| | | 350° | 35 | 13.7% | | |
| 360° | 36 | 14.1% | | | | |
| No function | 37-39 | 14.5-15.3% | | | | |

| | | | | | | |
|----------|--|--|---------|------------|--|--|
| 7 | Special / Control (continued) | Position feedback on* | 40-44 | 15.7-17.3% | | |
| | | Position feedback off* | 45-49 | 17.7-19.2% | | |
| | | Barndoor on* | 50-54 | 19.6-21.2% | | |
| | | Barndoor off* | 55-59 | 21.6-23.1% | | |
| | | No function | 60-61 | 23.5-23.9% | | |
| | | Tilt power on* | 62-63 | 24.3-24.7% | | |
| | | Tilt power off* | 64-65 | 25.1-25.5% | | |
| | | Tilt reset on* | 66-67 | 25.9-26.3% | | |
| | | Tilt reset off* | 68-69 | 26.7-27.1% | | |
| | | Normal tilt control* | 70-74 | 27.5-29.0% | | |
| | | Inverse tilt control* | 75-79 | 29.4-31.0% | | |
| | | Normal pixel numbering, plates 1+2 | 80-84 | 31.4-32.9% | | |
| | | Inverse pixel numbering, plates 1+2 | 85-89 | 33.3-34.9% | | |
| | | Normal pixel numbering, 2nd plate | 90-94 | 35.3-36.9% | | |
| | | Inverse pixel numbering, 2nd plate | 95-99 | 37.3-38.8% | | |
| | | Linear dimming curve | 100-101 | 39.2-39.6% | | |
| | | Soft dimming curve | 102-103 | 40.0-40.4% | | |
| | | Extra-soft dimming curve | 104-105 | 40.8-41.2% | | |
| | | No function | 106-120 | 41.6-47.1% | | |
| | | PWM frequency (hold value for >3 seconds): | | | | |
| | | 582 Hz | 121-122 | 47.5-47.8% | | |
| | | 583 Hz | 123-124 | 48.2-48.6% | | |
| | | 584 Hz | 125-126 | 49.0-49.4% | | |
| | | 585 Hz | 127-128 | 49.8-50.2% | | |
| | | 586 Hz | 129-130 | 50.6-51.0% | | |
| | | 587 Hz | 131-132 | 51.4-51.8% | | |
| | | 588 Hz | 133-134 | 52.2-52.5% | | |
| | | 589 Hz | 135-136 | 52.9-53.3% | | |
| | | 590 Hz | 137-138 | 53.7-54.1% | | |
| | | 591 Hz | 139-140 | 54.5-54.9% | | |
| | | 592 Hz | 141-142 | 55.3-55.7% | | |
| | | 593 Hz | 143-144 | 56.1-56.5% | | |
| | | 594 Hz | 145-146 | 56.9-57.3% | | |
| | | 595 Hz | 147-148 | 57.6-58.0% | | |
| | | 596 Hz | 149-150 | 58.4-58.8% | | |
| | | 597 Hz | 151-152 | 59.2-59.6% | | |
| | | 598 Hz | 153-154 | 60.0-60.4% | | |
| | | 599 Hz | 155-156 | 60.8-61.2% | | |
| | | 600 Hz | 157-158 | 61.6-62.0% | | |
| | | 601 Hz | 159-160 | 62.4-62.7% | | |
| | | 602 Hz | 161-162 | 63.1-63.5% | | |
| | | 603 Hz | 163-164 | 63.9-64.3% | | |
| | | 604 Hz | 165-166 | 64.7-65.1% | | |
| | | 605 Hz | 167-168 | 65.5-65.9% | | |
| 606 Hz | 169-170 | 66.3-66.7% | | | | |
| 607 Hz | 171-172 | 67.1-67.5% | | | | |
| 608 Hz | 173-174 | 67.8-68.2% | | | | |
| 609 Hz | 175-176 | 68.6-69.0% | | | | |
| 610 Hz | 177-178 | 69.4-69.8% | | | | |
| 611 Hz | 179-180 | 70.2-70.6% | | | | |

| | | | | | | |
|--|---------------------------------|---|---------|------------|-----|------|
| 7 | Special /Control (continued) | 612 Hz | 181-182 | 71.0-71.4% | | |
| | | 613 Hz | 183-184 | 71.8-72.2% | | |
| | | 614 Hz | 185-186 | 72.5-72.9% | | |
| | | 615 Hz | 187-188 | 73.3-73.7% | | |
| | | 616 Hz | 189-190 | 74.1-74.5% | | |
| | | 617 Hz | 191-192 | 74.9-75.3% | | |
| | | 618 Hz | 193-194 | 75.6-76.1% | | |
| | | 1200 Hz | 195-197 | 76.5-77.3% | | |
| | | 2400 Hz | 198-200 | 77.6-78.4% | | |
| | | Fan mode = Auto | 201-204 | 78.8-80.0% | | |
| | | Fan mode = High | 205-209 | 80.4-82.0% | | |
| | | Percentage flash mode (hold for >0.5 sec.) | 210-214 | 82.5-84.0% | | |
| | | Normal flash mode (hold for >0.5 sec.) | 215-219 | 84.5-85.0% | | |
| | | Dimmer flash mode on* | 220-224 | 86.0-87.5% | | |
| | | Dimmer flash mode off* | 225-229 | 88.0-90.0% | | |
| | | FX color priority = Beam* | 230-233 | 90.5-91.4% | | |
| | | FX color priority = Mixed* | 234-236 | 91.8-92.5% | | |
| FX color priority = Plate* | 237-239 | 92.9-93.7% | | | | |
| Aggressive flash mode (hold for >0.5 sec.) | 240-244 | 94.1-95.7% | | | | |
| No function | 245-247 | 96.1-96.9% | | | | |
| Reset (hold value for >5 sec.) | 248-255 | 97.3-100% | | | | |
| 8 | Plate Intensity | Intensity 0-100% | 0-255 | 0-100% | 0 | Fade |
| 9 | Plate Flash Duration | 7-650 ms | 0-255 | 0-100% | 255 | Fade |
| 10 | Plate Flash Rate | 0.289-16.67 Hz | 0-255 | 0-100% | 255 | Fade |
| 11 | Plate Shutter | No function | 0 | 0% | 0 | Snap |
| | | Plate Shutter effects and FX patterns offset: | | | | |
| | | 10° | 1 | 0.4% | | |
| | | 20° | 2 | 0.8% | | |
| | | 30° | 3 | 1.2% | | |
| | | 40° | 4 | 1.6% | | |
| | | 50° | 5 | 2.0% | | |
| | | 60° | 6 | 2.4% | | |
| | | 70° | 7 | 2.8% | | |
| | | 80° | 8 | 3.1% | | |
| | | 90° | 9 | 3.5% | | |
| | | 100° | 10 | 3.9% | | |
| | | 110° | 11 | 4.3% | | |
| | | 120° | 12 | 4.7% | | |
| | | 130° | 13 | 5.1% | | |
| | | 140° | 14 | 5.5% | | |
| | | 150° | 15 | 5.9% | | |
| | | 160° | 16 | 6.3% | | |
| | | 170° | 17 | 6.7% | | |
| | | 180° | 18 | 7.1% | | |
| | | 190° | 19 | 7.5% | | |
| | | 200° | 20 | 7.8% | | |
| | | 210° | 21 | 8.2% | | |
| 220° | 22 | 8.6% | | | | |

| | | | | | | |
|----------------------|------------------------------|-----------------------------------|---------|------------|-----|------|
| 11 | Plate Shutter (continued) | 240° | 24 | 9.4% | | |
| | | 250° | 25 | 9.8% | | |
| | | 260° | 26 | 10.2% | | |
| | | 270° | 27 | 10.6% | | |
| | | 280° | 28 | 11.0% | | |
| | | 290° | 29 | 11.4% | | |
| | | 300° | 30 | 11.8% | | |
| | | 310° | 31 | 12.2% | | |
| | | 320° | 32 | 12.6% | | |
| | | 330° | 33 | 12.9% | | |
| | | 340° | 34 | 13.3% | | |
| | | 350° | 35 | 13.7% | | |
| | | 360° | 36 | 14.1% | | |
| | | Ramp up (fade on, snap off) | 37-40 | 14.5-15.5% | | |
| | | Ramp up, random | 41-44 | 16.0-17.0% | | |
| | | Ramp down | 45-48 | 17.5-18.5% | | |
| | | Ramp down, random | 49-52 | 19.0-20.0% | | |
| | | Ramp up / down | 53-56 | 20.5-21.5% | | |
| | | Ramp up / down, random | 57-60 | 22.0-23.0% | | |
| | | Random white beam | 61-64 | 23.5-24.5% | | |
| | | Random single pixel in white beam | 65-68 | 25.0-26.0% | | |
| | | Lightning | 69-72 | 26.5-27.5% | | |
| | | Spikes (flash over low light) | 73-76 | 28.0-29.0% | | |
| | | No function | 77-179 | 29.5-70.0% | | |
| | | Double flash | 180-191 | 70.6-74.9% | | |
| | | Double flash, random | 192-203 | 75.3-79.6% | | |
| | | Triple flash | 204-215 | 80.0-84.3% | | |
| Triple flash, random | 216-227 | 84.7-89.0% | | | | |
| Quad flash | 228-239 | 89.4-93.7% | | | | |
| Quad flash, random | 240-251 | 94.1-98.4% | | | | |
| No effect | 252-255 | 98.5-100% | | | | |
| 12 | Plates Red | Plates red intensity 0-100% | 0-255 | 0-100% | 255 | Fade |
| 13 | Plates Green | Plates green intensity 0-100% | 0-255 | 0-100% | 255 | Fade |
| 14 | Plates Blue | Plates blue intensity 0-100% | 0-255 | 0-100% | 255 | Fade |

DMX Mode 2 (Normal), 23 DMX Channels

Tilt, Beam shutter, special/control, Plates shutter, Plates grouped RGB, Plate and Beam FX, Plates background grouped RGB

| Channel | Command | DMX range | Percent | Default DMX | Fade | |
|-------------------------------|--------------------------|--|---------|-------------|------|------|
| 1 | Coarse Tilt (MSB) | 0-185° | 0-255 | 0-100% | 127 | Fade |
| 2 | Fine Tilt (LSB) | Coarse tilt + 0-1.2° | 0-255 | 0-100% | 127 | Fade |
| 3 | Beam Intensity | Intensity 0-100% | 0-255 | 0-100% | 0 | Fade |
| 4 | Beam Duration | Flash duration 7-650 ms | 0-255 | 0-100% | 255 | Fade |
| 5 | Beam Rate | Flash rate 0.289-16.67 Hz | 0-255 | 0-100% | 255 | Fade |
| 6 | Beam Shutter | No effect | 0-36 | 0-14.0% | 0 | Snap |
| | | Ramp up (= fade on, snap off) | 37-40 | 14.5-15.5% | | |
| | | Ramp up random | 41-44 | 16.0-17.0% | | |
| | | Ramp down | 45-48 | 17.5-18.5% | | |
| | | Ramp down random | 49-52 | 19.0-20.0% | | |
| | | Ramp up down | 53-56 | 20.5-21.5% | | |
| | | Ramp up down random | 57-60 | 22.0-23.0% | | |
| | | Random white beam | 61-64 | 23.5-24.5% | | |
| | | Random single pixel of white beam | 65-68 | 25.0-26.0% | | |
| | | Lightning | 69-72 | 26.5-27.5% | | |
| | | Spikes (flash over low light) | 73-76 | 28.0-29.0% | | |
| | | White beam, left to right | 77-80 | 30.0-31.5% | | |
| | | White beam, left to right, random | 81-84 | 32.0-33.0% | | |
| | | White beam, right to left | 85-88 | 33.5-34.5% | | |
| | | White beam, right to left, random | 89-92 | 35.0-36.0% | | |
| | | White beam, left to right, bounce | 93-96 | 36.5-37.5% | | |
| | | White beam, left to right, bounce, random | 97-100 | 38.0-39.0% | | |
| | | White beam, right to left, bounce | 101-104 | 39.5-40.5% | | |
| | | White beam, right to left, bounce, random | 105-108 | 41.0-42.5% | | |
| | | Zig, 6 steps, outer to center pixels | 109-112 | 43.0-43.5% | | |
| | | Zig, 6 steps, outer to center pixels random | 113-116 | 44.0-45.5% | | |
| | | Zag, 6 steps, center to outer pixels | 117-120 | 46.0-47.0% | | |
| | | Zag, 6 steps, center to outer pixels, random | 121-124 | 47.5-48.5% | | |
| | | Zigzag, 10 steps | 125-128 | 49.0-50.0% | | |
| | | Zigzag, 10 steps, random | 129-132 | 50.5-52.0% | | |
| | | No function | 133-179 | 52.5-70.0% | | |
| | | Double flash | 180-183 | 70.6-71.8% | | |
| | | Double flash, random | 184-187 | 72.2-73.3% | | |
| | | Double flash, b-c (beam-color) | 188-191 | 73.7-74.9% | | |
| | | Double flash, b-c, random | 192-195 | 75.3-76.5% | | |
| | | Double flash, c-b (color-beam) | 196-199 | 76.9-78.0% | | |
| | | Double flash, c-b, random | 200-203 | 78.4-79.6% | | |
| Triple flash | 204-207 | 80.0-81.2% | | | | |
| Triple flash, random | 208-211 | 81.6-82.7% | | | | |
| Triple flash, beam-color-beam | 212-215 | 83.1-84.3% | | | | |
| Triple flash, b-c-b, random | 216-219 | 84.7-85.9% | | | | |
| Triple flash, c-b-c | 220-223 | 86.3-87.5% | | | | |
| Triple flash, c-b-c, random | 224-227 | 87.8-89.0% | | | | |

| | | | | | | |
|-------------|-------------------------------------|--|---------|------------|---|------|
| 6 | Beam Shutter (continued) | Quad flash | 228-231 | 89.4-90.6% | | |
| | | Quad flash, random | 232-235 | 91.0-92.2% | | |
| | | Quad flash, b-c-b-c | 236-239 | 92.5-93.7% | | |
| | | Quad flash, b-c-b-c, random | 240-243 | 94.1-95.3% | | |
| | | Quad flash, c-b-c-b | 244-247 | 95.7-96.9% | | |
| | | Quad flash, c-b-c-b, random | 248-251 | 97.3-98.4% | | |
| | | No function | 252-255 | 98.5-100% | | |
| 7 | Special / Control | No function | 0 | 0% | 0 | Snap |
| | | Beam Shutter effects and FX patterns offset: | | | | |
| | | 10° | 1 | 0.4% | | |
| | | 20° | 2 | 0.8% | | |
| | | 30° | 3 | 1.2% | | |
| | | 40° | 4 | 1.6% | | |
| | | 50° | 5 | 2.0% | | |
| | | 60° | 6 | 2.4% | | |
| | | 70° | 7 | 2.8% | | |
| | | 80° | 8 | 3.1% | | |
| | | 90° | 9 | 3.5% | | |
| | | 100° | 10 | 3.9% | | |
| | | 110° | 11 | 4.3% | | |
| | | 120° | 12 | 4.7% | | |
| | | 130° | 13 | 5.1% | | |
| | | 140° | 14 | 5.5% | | |
| | | 150° | 15 | 5.9% | | |
| | | 160° | 16 | 6.3% | | |
| | | 170° | 17 | 6.7% | | |
| | | 180° | 18 | 7.1% | | |
| | | 190° | 19 | 7.5% | | |
| | | 200° | 20 | 7.8% | | |
| | | 210° | 21 | 8.2% | | |
| | | 220° | 22 | 8.6% | | |
| | | 230° | 23 | 9.0% | | |
| | | 240° | 24 | 9.4% | | |
| | | 250° | 25 | 9.8% | | |
| | | 260° | 26 | 10.2% | | |
| | | 270° | 27 | 10.6% | | |
| | | 280° | 28 | 11.0% | | |
| | | 290° | 29 | 11.4% | | |
| | | 300° | 30 | 11.8% | | |
| | | 310° | 31 | 12.2% | | |
| | | 320° | 32 | 12.6% | | |
| | | 330° | 33 | 12.9% | | |
| | | 340° | 34 | 13.3% | | |
| | | 350° | 35 | 13.7% | | |
| 360° | 36 | 14.1% | | | | |
| No function | 37-39 | 14.5-15.3% | | | | |

| | | | | | | |
|--------|----------------------------------|--|---------|------------|--|--|
| 7 | Special / Control (continued) | Position feedback on* | 40-44 | 15.7-17.3% | | |
| | | Position feedback off* | 45-49 | 17.7-19.2% | | |
| | | Barndoor on* | 50-54 | 19.6-21.2% | | |
| | | Barndoor off* | 55-59 | 21.6-23.1% | | |
| | | No function | 60-61 | 23.5-23.9% | | |
| | | Tilt power on* | 62-63 | 24.3-24.7% | | |
| | | Tilt power off* | 64-65 | 25.1-25.5% | | |
| | | Tilt reset on* | 66-67 | 25.9-26.3% | | |
| | | Tilt reset off* | 68-69 | 26.7-27.1% | | |
| | | Normal tilt control* | 70-74 | 27.5-29.0% | | |
| | | Inverse tilt control* | 75-79 | 29.4-31.0% | | |
| | | Normal pixel numbering, plates 1+2 | 80-84 | 31.4-32.9% | | |
| | | Inverse pixel numbering, plates 1+2 | 85-89 | 33.3-34.9% | | |
| | | Normal pixel numbering, 2nd plate | 90-94 | 35.3-36.9% | | |
| | | Inverse pixel numbering, 2nd plate | 95-99 | 37.3-38.8% | | |
| | | Linear dimming curve | 100-101 | 39.2-39.6% | | |
| | | Soft dimming curve | 102-103 | 40.0-40.4% | | |
| | | Extra-soft dimming curve | 104-105 | 40.8-41.2% | | |
| | | No function | 106-120 | 41.6-47.1% | | |
| | | PWM frequency (hold value for >3 seconds): | | | | |
| | | 582 Hz | 121-122 | 47.5-47.8% | | |
| | | 583 Hz | 123-124 | 48.2-48.6% | | |
| | | 584 Hz | 125-126 | 49.0-49.4% | | |
| | | 585 Hz | 127-128 | 49.8-50.2% | | |
| | | 586 Hz | 129-130 | 50.6-51.0% | | |
| | | 587 Hz | 131-132 | 51.4-51.8% | | |
| | | 588 Hz | 133-134 | 52.2-52.5% | | |
| | | 589 Hz | 135-136 | 52.9-53.3% | | |
| | | 590 Hz | 137-138 | 53.7-54.1% | | |
| | | 591 Hz | 139-140 | 54.5-54.9% | | |
| | | 592 Hz | 141-142 | 55.3-55.7% | | |
| | | 593 Hz | 143-144 | 56.1-56.5% | | |
| | | 594 Hz | 145-146 | 56.9-57.3% | | |
| | | 595 Hz | 147-148 | 57.6-58.0% | | |
| | | 596 Hz | 149-150 | 58.4-58.8% | | |
| | | 597 Hz | 151-152 | 59.2-59.6% | | |
| | | 598 Hz | 153-154 | 60.0-60.4% | | |
| | | 599 Hz | 155-156 | 60.8-61.2% | | |
| | | 600 Hz | 157-158 | 61.6-62.0% | | |
| | | 601 Hz | 159-160 | 62.4-62.7% | | |
| | | 602 Hz | 161-162 | 63.1-63.5% | | |
| | | 603 Hz | 163-164 | 63.9-64.3% | | |
| | | 604 Hz | 165-166 | 64.7-65.1% | | |
| | | 605 Hz | 167-168 | 65.5-65.9% | | |
| | | 606 Hz | 169-170 | 66.3-66.7% | | |
| | | 607 Hz | 171-172 | 67.1-67.5% | | |
| | | 608 Hz | 173-174 | 67.8-68.2% | | |
| 609 Hz | 175-176 | 68.6-69.0% | | | | |
| 610 Hz | 177-178 | 69.4-69.8% | | | | |
| 611 Hz | 179-180 | 70.2-70.6% | | | | |

| | | | | | | |
|--|---|---|---------|------------|-----|------|
| 7 | Special /Control (continued) | 612 Hz | 181-182 | 71.0-71.4% | | |
| | | 613 Hz | 183-184 | 71.8-72.2% | | |
| | | 614 Hz | 185-186 | 72.5-72.9% | | |
| | | 615 Hz | 187-188 | 73.3-73.7% | | |
| | | 616 Hz | 189-190 | 74.1-74.5% | | |
| | | 617 Hz | 191-192 | 74.9-75.3% | | |
| | | 618 Hz | 193-194 | 75.6-76.1% | | |
| | | 1200 Hz | 195-197 | 76.5-77.3% | | |
| | | 2400 Hz | 198-200 | 77.6-78.4% | | |
| | | Fan mode = Auto | 201-204 | 78.8-80.0% | | |
| | | Fan mode = High | 205-209 | 80.4-82.0% | | |
| | | Percentage flash mode (hold for >0.5 sec.) | 210-214 | 82.5-84.0% | | |
| | | Normal flash mode (hold for >0.5 sec.) | 215-219 | 84.5-85.0% | | |
| | | Dimmer flash mode on* | 220-224 | 86.0-87.5% | | |
| | | Dimmer flash mode off* | 225-229 | 88.0-90.0% | | |
| | | FX color priority = Beam* | 230-233 | 90.5-91.4% | | |
| | | FX color priority = Mixed* | 234-236 | 91.8-92.5% | | |
| FX color priority = Plate* | 237-239 | 92.9-93.7% | | | | |
| Aggressive flash mode (hold for >0.5 sec.) | 240-244 | 94.1-95.7% | | | | |
| No function | 245-247 | 96.1-96.9% | | | | |
| Reset (hold value for >5 sec.) | 248-255 | 97.3-100% | | | | |
| 8 | Plate Intensity | Intensity 0-100% | 0-255 | 0-100% | 0 | Fade |
| 9 | Plate Flash Duration | 7-650 ms | 0-255 | 0-100% | 255 | Fade |
| 10 | Plate Flash Rate | 0.289-16.67 Hz | 0-255 | 0-100% | 255 | Fade |
| 11 | Plate Shutter | No function | 0 | 0% | 0 | Snap |
| | | Plate Shutter effects and FX patterns offset: | | | | |
| | | 10° | 1 | 0.4% | | |
| | | 20° | 2 | 0.8% | | |
| | | 30° | 3 | 1.2% | | |
| | | 40° | 4 | 1.6% | | |
| | | 50° | 5 | 2.0% | | |
| | | 60° | 6 | 2.4% | | |
| | | 70° | 7 | 2.8% | | |
| | | 80° | 8 | 3.1% | | |
| | | 90° | 9 | 3.5% | | |
| | | 100° | 10 | 3.9% | | |
| | | 110° | 11 | 4.3% | | |
| | | 120° | 12 | 4.7% | | |
| | | 130° | 13 | 5.1% | | |
| | | 140° | 14 | 5.5% | | |
| | | 150° | 15 | 5.9% | | |
| | | 160° | 16 | 6.3% | | |
| | | 170° | 17 | 6.7% | | |
| | | 180° | 18 | 7.1% | | |
| | | 190° | 19 | 7.5% | | |
| | | 200° | 20 | 7.8% | | |
| | | 210° | 21 | 8.2% | | |
| 220° | 22 | 8.6% | | | | |

| | | | | | | |
|----------------------|------------------------------|--------------------------------------|---------|------------|-----|------|
| 11 | Plate Shutter (continued) | 240° | 24 | 9.4% | | |
| | | 250° | 25 | 9.8% | | |
| | | 260° | 26 | 10.2% | | |
| | | 270° | 27 | 10.6% | | |
| | | 280° | 28 | 11.0% | | |
| | | 290° | 29 | 11.4% | | |
| | | 300° | 30 | 11.8% | | |
| | | 310° | 31 | 12.2% | | |
| | | 320° | 32 | 12.6% | | |
| | | 330° | 33 | 12.9% | | |
| | | 340° | 34 | 13.3% | | |
| | | 350° | 35 | 13.7% | | |
| | | 360° | 36 | 14.1% | | |
| | | Ramp up (fade on, snap off) | 37-40 | 14.5-15.5% | | |
| | | Ramp up, random | 41-44 | 16.0-17.0% | | |
| | | Ramp down | 45-48 | 17.5-18.5% | | |
| | | Ramp down, random | 49-52 | 19.0-20.0% | | |
| | | Ramp up / down | 53-56 | 20.5-21.5% | | |
| | | Ramp up / down, random | 57-60 | 22.0-23.0% | | |
| | | Random white beam | 61-64 | 23.5-24.5% | | |
| | | Random single pixel in white beam | 65-68 | 25.0-26.0% | | |
| | | Lightning | 69-72 | 26.5-27.5% | | |
| | | Spikes (flash over low light) | 73-76 | 28.0-29.0% | | |
| | | No function | 77-179 | 29.5-70.0% | | |
| | | Double flash | 180-191 | 70.6-74.9% | | |
| | | Double flash, random | 192-203 | 75.3-79.6% | | |
| Triple flash | 204-215 | 80.0-84.3% | | | | |
| Triple flash, random | 216-227 | 84.7-89.0% | | | | |
| Quad flash | 228-239 | 89.4-93.7% | | | | |
| Quad flash, random | 240-251 | 94.1-98.4% | | | | |
| No effect | 252-255 | 98.5-100% | | | | |
| 12 | Plates Red | Plates red intensity 0-100% | 0-255 | 0-100% | 255 | Fade |
| 13 | Plates Green | Plates green intensity 0-100% | 0-255 | 0-100% | 255 | Fade |
| 14 | Plates Blue | Plates blue intensity 0-100% | 0-255 | 0-100% | 255 | Fade |
| 15 | FX Crossfade | Crossfade duration snap - slow | 0-255 | 0-100% | 0 | Fade |
| 16 | Plate FX Movement | Plate FX movement speed slow - fast | 0-255 | 0-100% | 0 | Snap |
| 17 | Plate FX Select | Plate FX pattern select | 0-255 | 0-100% | 0 | Snap |
| 18 | Beam FX Movement | Beam FX movement speed slow - fast | 0-255 | 0-100% | 0 | Snap |
| 19 | Beam FX Select | Beam FX pattern select | 0-255 | 0-100% | 0 | Snap |
| 20 | Plates Master | FX background intensity 0-100% | 0-255 | 0-100% | 0 | Fade |
| 21 | Plates Background Red | FX background intensity red 0-100% | 0-255 | 0-100% | 255 | Fade |
| 22 | Plates Background Green | FX background intensity green 0-100% | 0-255 | 0-100% | 255 | Fade |
| 23 | Plates Background Blue | FX background intensity blue 0-100% | 0-255 | 0-100% | 255 | Fade |

DMX Mode 3 (SPix), 68 DMX Channels

Tilt, Beam shutter, special/control, Plates shutter, Plates grouped RGB, Plate and Beam FX, Plate background individual pixel RGB, Beam individual pixel intensity

| Channel | Command | DMX range | Percent | Default DMX | Fade | |
|-------------------------------|--------------------------|--|---------|-------------|------|------|
| 1 | Coarse Tilt (MSB) | 0-185° | 0-255 | 0-100% | 127 | Fade |
| 2 | Fine Tilt (LSB) | Coarse tilt + 0-1.2° | 0-255 | 0-100% | 127 | Fade |
| 3 | Beam Intensity | Intensity 0-100% | 0-255 | 0-100% | 0 | Fade |
| 4 | Beam Duration | Flash duration 7-650 ms | 0-255 | 0-100% | 255 | Fade |
| 5 | Beam Rate | Flash rate 0.289-16.67 Hz | 0-255 | 0-100% | 255 | Fade |
| 6 | Beam Shutter | No effect | 0-36 | 0-14.0% | 0 | Snap |
| | | Ramp up (= fade on, snap off) | 37-40 | 14.5-15.5% | | |
| | | Ramp up random | 41-44 | 16.0-17.0% | | |
| | | Ramp down | 45-48 | 17.5-18.5% | | |
| | | Ramp down random | 49-52 | 19.0-20.0% | | |
| | | Ramp up down | 53-56 | 20.5-21.5% | | |
| | | Ramp up down random | 57-60 | 22.0-23.0% | | |
| | | Random white beam | 61-64 | 23.5-24.5% | | |
| | | Random single pixel of white beam | 65-68 | 25.0-26.0% | | |
| | | Lightning | 69-72 | 26.5-27.5% | | |
| | | Spikes (flash over low light) | 73-76 | 28.0-29.0% | | |
| | | White beam, left to right | 77-80 | 30.0-31.5% | | |
| | | White beam, left to right, random | 81-84 | 32.0-33.0% | | |
| | | White beam, right to left | 85-88 | 33.5-34.5% | | |
| | | White beam, right to left, random | 89-92 | 35.0-36.0% | | |
| | | White beam, left to right, bounce | 93-96 | 36.5-37.5% | | |
| | | White beam, left to right, bounce, random | 97-100 | 38.0-39.0% | | |
| | | White beam, right to left, bounce | 101-104 | 39.5-40.5% | | |
| | | White beam, right to left, bounce, random | 105-108 | 41.0-42.5% | | |
| | | Zig, 6 steps, outer to center pixels | 109-112 | 43.0-43.5% | | |
| | | Zig, 6 steps, outer to center pixels random | 113-116 | 44.0-45.5% | | |
| | | Zag, 6 steps, center to outer pixels | 117-120 | 46.0-47.0% | | |
| | | Zag, 6 steps, center to outer pixels, random | 121-124 | 47.5-48.5% | | |
| | | Zigzag, 10 steps | 125-128 | 49.0-50.0% | | |
| | | Zigzag, 10 steps, random | 129-132 | 50.5-52.0% | | |
| | | No function | 133-179 | 52.5-70.0% | | |
| | | Double flash | 180-183 | 70.6-71.8% | | |
| | | Double flash, random | 184-187 | 72.2-73.3% | | |
| | | Double flash, b-c (beam-color) | 188-191 | 73.7-74.9% | | |
| | | Double flash, b-c, random | 192-195 | 75.3-76.5% | | |
| | | Double flash, c-b (color-beam) | 196-199 | 76.9-78.0% | | |
| | | Double flash, c-b, random | 200-203 | 78.4-79.6% | | |
| Triple flash | 204-207 | 80.0-81.2% | | | | |
| Triple flash, random | 208-211 | 81.6-82.7% | | | | |
| Triple flash, beam-color-beam | 212-215 | 83.1-84.3% | | | | |
| Triple flash, b-c-b, random | 216-219 | 84.7-85.9% | | | | |
| Triple flash, c-b-c | 220-223 | 86.3-87.5% | | | | |
| Triple flash, c-b-c, random | 224-227 | 87.8-89.0% | | | | |

| | | | | | | |
|-------------|-----------------------------|--|---------|------------|---|------|
| 6 | Beam Shutter (continued) | Quad flash | 228-231 | 89.4-90.6% | | |
| | | Quad flash, random | 232-235 | 91.0-92.2% | | |
| | | Quad flash, b-c-b-c | 236-239 | 92.5-93.7% | | |
| | | Quad flash, b-c-b-c, random | 240-243 | 94.1-95.3% | | |
| | | Quad flash, c-b-c-b | 244-247 | 95.7-96.9% | | |
| | | Quad flash, c-b-c-b, random | 248-251 | 97.3-98.4% | | |
| | | No function | 252-255 | 98.5-100% | | |
| 7 | Special / Control | No function | 0 | 0% | 0 | Snap |
| | | Beam Shutter effects and FX patterns offset: | | | | |
| | | 10° | 1 | 0.4% | | |
| | | 20° | 2 | 0.8% | | |
| | | 30° | 3 | 1.2% | | |
| | | 40° | 4 | 1.6% | | |
| | | 50° | 5 | 2.0% | | |
| | | 60° | 6 | 2.4% | | |
| | | 70° | 7 | 2.8% | | |
| | | 80° | 8 | 3.1% | | |
| | | 90° | 9 | 3.5% | | |
| | | 100° | 10 | 3.9% | | |
| | | 110° | 11 | 4.3% | | |
| | | 120° | 12 | 4.7% | | |
| | | 130° | 13 | 5.1% | | |
| | | 140° | 14 | 5.5% | | |
| | | 150° | 15 | 5.9% | | |
| | | 160° | 16 | 6.3% | | |
| | | 170° | 17 | 6.7% | | |
| | | 180° | 18 | 7.1% | | |
| | | 190° | 19 | 7.5% | | |
| | | 200° | 20 | 7.8% | | |
| | | 210° | 21 | 8.2% | | |
| | | 220° | 22 | 8.6% | | |
| | | 230° | 23 | 9.0% | | |
| | | 240° | 24 | 9.4% | | |
| | | 250° | 25 | 9.8% | | |
| | | 260° | 26 | 10.2% | | |
| | | 270° | 27 | 10.6% | | |
| | | 280° | 28 | 11.0% | | |
| | | 290° | 29 | 11.4% | | |
| | | 300° | 30 | 11.8% | | |
| | | 310° | 31 | 12.2% | | |
| | | 320° | 32 | 12.6% | | |
| | | 330° | 33 | 12.9% | | |
| | | 340° | 34 | 13.3% | | |
| | | 350° | 35 | 13.7% | | |
| 360° | 36 | 14.1% | | | | |
| No function | 37-39 | 14.5-15.3% | | | | |

| | | | | | | |
|----------|--|--|---------|------------|--|--|
| 7 | Special / Control (continued) | Position feedback on* | 40-44 | 15.7-17.3% | | |
| | | Position feedback off* | 45-49 | 17.7-19.2% | | |
| | | Barndoor on* | 50-54 | 19.6-21.2% | | |
| | | Barndoor off* | 55-59 | 21.6-23.1% | | |
| | | No function | 60-61 | 23.5-23.9% | | |
| | | Tilt power on* | 62-63 | 24.3-24.7% | | |
| | | Tilt power off* | 64-65 | 25.1-25.5% | | |
| | | Tilt reset on* | 66-67 | 25.9-26.3% | | |
| | | Tilt reset off* | 68-69 | 26.7-27.1% | | |
| | | Normal tilt control* | 70-74 | 27.5-29.0% | | |
| | | Inverse tilt control* | 75-79 | 29.4-31.0% | | |
| | | Normal pixel numbering, plates 1+2 | 80-84 | 31.4-32.9% | | |
| | | Inverse pixel numbering, plates 1+2 | 85-89 | 33.3-34.9% | | |
| | | Normal pixel numbering, 2nd plate | 90-94 | 35.3-36.9% | | |
| | | Inverse pixel numbering, 2nd plate | 95-99 | 37.3-38.8% | | |
| | | Linear dimming curve | 100-101 | 39.2-39.6% | | |
| | | Soft dimming curve | 102-103 | 40.0-40.4% | | |
| | | Extra-soft dimming curve | 104-105 | 40.8-41.2% | | |
| | | No function | 106-120 | 41.6-47.1% | | |
| | | PWM frequency (hold value for >3 seconds): | | | | |
| | | 582 Hz | 121-122 | 47.5-47.8% | | |
| | | 583 Hz | 123-124 | 48.2-48.6% | | |
| | | 584 Hz | 125-126 | 49.0-49.4% | | |
| | | 585 Hz | 127-128 | 49.8-50.2% | | |
| | | 586 Hz | 129-130 | 50.6-51.0% | | |
| | | 587 Hz | 131-132 | 51.4-51.8% | | |
| | | 588 Hz | 133-134 | 52.2-52.5% | | |
| | | 589 Hz | 135-136 | 52.9-53.3% | | |
| | | 590 Hz | 137-138 | 53.7-54.1% | | |
| | | 591 Hz | 139-140 | 54.5-54.9% | | |
| | | 592 Hz | 141-142 | 55.3-55.7% | | |
| | | 593 Hz | 143-144 | 56.1-56.5% | | |
| | | 594 Hz | 145-146 | 56.9-57.3% | | |
| | | 595 Hz | 147-148 | 57.6-58.0% | | |
| | | 596 Hz | 149-150 | 58.4-58.8% | | |
| | | 597 Hz | 151-152 | 59.2-59.6% | | |
| | | 598 Hz | 153-154 | 60.0-60.4% | | |
| | | 599 Hz | 155-156 | 60.8-61.2% | | |
| | | 600 Hz | 157-158 | 61.6-62.0% | | |
| | | 601 Hz | 159-160 | 62.4-62.7% | | |
| | | 602 Hz | 161-162 | 63.1-63.5% | | |
| | | 603 Hz | 163-164 | 63.9-64.3% | | |
| | | 604 Hz | 165-166 | 64.7-65.1% | | |
| | | 605 Hz | 167-168 | 65.5-65.9% | | |
| | | 606 Hz | 169-170 | 66.3-66.7% | | |
| | | 607 Hz | 171-172 | 67.1-67.5% | | |
| | | 608 Hz | 173-174 | 67.8-68.2% | | |
| 609 Hz | 175-176 | 68.6-69.0% | | | | |
| 610 Hz | 177-178 | 69.4-69.8% | | | | |
| 611 Hz | 179-180 | 70.2-70.6% | | | | |

| | | | | | | |
|--|---------------------------------|---|---------|------------|-----|------|
| 7 | Special /Control (continued) | 612 Hz | 181-182 | 71.0-71.4% | | |
| | | 613 Hz | 183-184 | 71.8-72.2% | | |
| | | 614 Hz | 185-186 | 72.5-72.9% | | |
| | | 615 Hz | 187-188 | 73.3-73.7% | | |
| | | 616 Hz | 189-190 | 74.1-74.5% | | |
| | | 617 Hz | 191-192 | 74.9-75.3% | | |
| | | 618 Hz | 193-194 | 75.6-76.1% | | |
| | | 1200 Hz | 195-197 | 76.5-77.3% | | |
| | | 2400 Hz | 198-200 | 77.6-78.4% | | |
| | | Fan mode = Auto | 201-204 | 78.8-80.0% | | |
| | | Fan mode = High | 205-209 | 80.4-82.0% | | |
| | | Percentage flash mode (hold for >0.5 sec.) | 210-214 | 82.5-84.0% | | |
| | | Normal flash mode (hold for >0.5 sec.) | 215-219 | 84.5-85.0% | | |
| | | Dimmer flash mode on* | 220-224 | 86.0-87.5% | | |
| | | Dimmer flash mode off* | 225-229 | 88.0-90.0% | | |
| | | FX color priority = Beam* | 230-233 | 90.5-91.4% | | |
| | | FX color priority = Mixed* | 234-236 | 91.8-92.5% | | |
| FX color priority = Plate* | 237-239 | 92.9-93.7% | | | | |
| Aggressive flash mode (hold for >0.5 sec.) | 240-244 | 94.1-95.7% | | | | |
| No function | 245-247 | 96.1-96.9% | | | | |
| Reset (hold value for >5 sec.) | 248-255 | 97.3-100% | | | | |
| 8 | Plate Intensity | Intensity 0-100% | 0-255 | 0-100% | 0 | Fade |
| 9 | Plate Flash Duration | 7-650 ms | 0-255 | 0-100% | 255 | Fade |
| 10 | Plate Flash Rate | 0.289-16.67 Hz | 0-255 | 0-100% | 255 | Fade |
| 11 | Plate Shutter | No function | 0 | 0% | 0 | Snap |
| | | Plate Shutter effects and FX patterns offset: | | | | |
| | | 10° | 1 | 0.4% | | |
| | | 20° | 2 | 0.8% | | |
| | | 30° | 3 | 1.2% | | |
| | | 40° | 4 | 1.6% | | |
| | | 50° | 5 | 2.0% | | |
| | | 60° | 6 | 2.4% | | |
| | | 70° | 7 | 2.8% | | |
| | | 80° | 8 | 3.1% | | |
| | | 90° | 9 | 3.5% | | |
| | | 100° | 10 | 3.9% | | |
| | | 110° | 11 | 4.3% | | |
| | | 120° | 12 | 4.7% | | |
| | | 130° | 13 | 5.1% | | |
| | | 140° | 14 | 5.5% | | |
| | | 150° | 15 | 5.9% | | |
| | | 160° | 16 | 6.3% | | |
| | | 170° | 17 | 6.7% | | |
| | | 180° | 18 | 7.1% | | |
| | | 190° | 19 | 7.5% | | |
| | | 200° | 20 | 7.8% | | |
| | | 210° | 21 | 8.2% | | |
| 220° | 22 | 8.6% | | | | |

| | | | | | | |
|----------------------|------------------------------|-------------------------------------|---------|------------|-----|------|
| 11 | Plate Shutter (continued) | 240° | 24 | 9.4% | | |
| | | 250° | 25 | 9.8% | | |
| | | 260° | 26 | 10.2% | | |
| | | 270° | 27 | 10.6% | | |
| | | 280° | 28 | 11.0% | | |
| | | 290° | 29 | 11.4% | | |
| | | 300° | 30 | 11.8% | | |
| | | 310° | 31 | 12.2% | | |
| | | 320° | 32 | 12.6% | | |
| | | 330° | 33 | 12.9% | | |
| | | 340° | 34 | 13.3% | | |
| | | 350° | 35 | 13.7% | | |
| | | 360° | 36 | 14.1% | | |
| | | Ramp up (fade on, snap off) | 37-40 | 14.5-15.5% | | |
| | | Ramp up, random | 41-44 | 16.0-17.0% | | |
| | | Ramp down | 45-48 | 17.5-18.5% | | |
| | | Ramp down, random | 49-52 | 19.0-20.0% | | |
| | | Ramp up / down | 53-56 | 20.5-21.5% | | |
| | | Ramp up / down, random | 57-60 | 22.0-23.0% | | |
| | | Random white beam | 61-64 | 23.5-24.5% | | |
| | | Random single pixel in white beam | 65-68 | 25.0-26.0% | | |
| | | Lightning | 69-72 | 26.5-27.5% | | |
| | | Spikes (flash over low light) | 73-76 | 28.0-29.0% | | |
| | | No function | 77-179 | 29.5-70.0% | | |
| | | Double flash | 180-191 | 70.6-74.9% | | |
| | | Double flash, random | 192-203 | 75.3-79.6% | | |
| | | Triple flash | 204-215 | 80.0-84.3% | | |
| Triple flash, random | 216-227 | 84.7-89.0% | | | | |
| Quad flash | 228-239 | 89.4-93.7% | | | | |
| Quad flash, random | 240-251 | 94.1-98.4% | | | | |
| No effect | 252-255 | 98.5-100% | | | | |
| 12 | Plates Red | Plates red intensity 0-100% | 0-255 | 0-100% | 255 | Fade |
| 13 | Plates Green | Plates green intensity 0-100% | 0-255 | 0-100% | 255 | Fade |
| 14 | Plates Blue | Plates blue intensity 0-100% | 0-255 | 0-100% | 255 | Fade |
| 15 | FX Crossfade | Crossfade duration snap - slow | 0-255 | 0-100% | 0 | Fade |
| 16 | Plate FX Movement | Plate FX movement speed slow - fast | 0-255 | 0-100% | 0 | Fade |
| 17 | Plate FX Select | Plate FX pattern select | 0-255 | 0-100% | 0 | Snap |
| 18 | Beam FX Movement | Beam FX movement speed slow - fast | 0-255 | 0-100% | 0 | Fade |
| 19 | Beam FX Select | Beam FX pattern select | 0-255 | 0-100% | 0 | Snap |
| 20 | Plate Master | FX background intensity 0-100% | 0-255 | 0-100% | 0 | Fade |
| 21 | Plate Background Pixel 1 | Red | 0-100% | 0-255 | 255 | Fade |
| 22 | | Green | 0-100% | 0-255 | 255 | Fade |
| 23 | | Blue | 0-100% | 0-255 | 255 | Fade |
| 24 | Plate Background Pixel 2 | Red | 0-100% | 0-255 | 255 | Fade |
| 25 | | Green | 0-100% | 0-255 | 255 | Fade |
| 26 | | Blue | 0-100% | 0-255 | 255 | Fade |
| 27 | Plate Background Pixel 3 | Red | 0-100% | 0-255 | 255 | Fade |
| 28 | | Green | 0-100% | 0-255 | 255 | Fade |
| 29 | | Blue | 0-100% | 0-255 | 255 | Fade |

| | | | | | | |
|----|---------------------------|----------|--------|-------|-----|------|
| 30 | Plate Background Pixel 4 | Red | 0-100% | 0-255 | 255 | Fade |
| 31 | | Green | 0-100% | 0-255 | 255 | Fade |
| 32 | | Blue | 0-100% | 0-255 | 255 | Fade |
| 33 | Plate Background Pixel 5 | Red | 0-100% | 0-255 | 255 | Fade |
| 34 | | Green | 0-100% | 0-255 | 255 | Fade |
| 35 | | Blue | 0-100% | 0-255 | 255 | Fade |
| 36 | Plate Background Pixel 6 | Red | 0-100% | 0-255 | 255 | Fade |
| 37 | | Green | 0-100% | 0-255 | 255 | Fade |
| 38 | | Blue | 0-100% | 0-255 | 255 | Fade |
| 39 | Plate Background Pixel 7 | Red | 0-100% | 0-255 | 255 | Fade |
| 40 | | Green | 0-100% | 0-255 | 255 | Fade |
| 41 | | Blue | 0-100% | 0-255 | 255 | Fade |
| 42 | Plate Background Pixel 8 | Red | 0-100% | 0-255 | 255 | Fade |
| 43 | | Green | 0-100% | 0-255 | 255 | Fade |
| 44 | | Blue | 0-100% | 0-255 | 255 | Fade |
| 45 | Plate Background Pixel 9 | Red | 0-100% | 0-255 | 255 | Fade |
| 46 | | Green | 0-100% | 0-255 | 255 | Fade |
| 47 | | Blue | 0-100% | 0-255 | 255 | Fade |
| 48 | Plate Background Pixel 10 | Red | 0-100% | 0-255 | 255 | Fade |
| 49 | | Green | 0-100% | 0-255 | 255 | Fade |
| 50 | | Blue | 0-100% | 0-255 | 255 | Fade |
| 51 | Plate Background Pixel 11 | Red | 0-100% | 0-255 | 255 | Fade |
| 52 | | Green | 0-100% | 0-255 | 255 | Fade |
| 53 | | Blue | 0-100% | 0-255 | 255 | Fade |
| 54 | Plate Background Pixel 12 | Red | 0-100% | 0-255 | 255 | Fade |
| 55 | | Green | 0-100% | 0-255 | 255 | Fade |
| 56 | | Blue | 0-100% | 0-255 | 255 | Fade |
| 57 | Beam Pixels Intensity | Pixel 1 | 0-100% | 0-255 | 0 | Fade |
| 58 | | Pixel 2 | 0-100% | 0-255 | 0 | Fade |
| 59 | | Pixel 3 | 0-100% | 0-255 | 0 | Fade |
| 60 | | Pixel 4 | 0-100% | 0-255 | 0 | Fade |
| 61 | | Pixel 5 | 0-100% | 0-255 | 0 | Fade |
| 62 | | Pixel 6 | 0-100% | 0-255 | 0 | Fade |
| 63 | | Pixel 7 | 0-100% | 0-255 | 0 | Fade |
| 64 | | Pixel 8 | 0-100% | 0-255 | 0 | Fade |
| 65 | | Pixel 9 | 0-100% | 0-255 | 0 | Fade |
| 66 | | Pixel 10 | 0-100% | 0-255 | 0 | Fade |
| 67 | | Pixel 11 | 0-100% | 0-255 | 0 | Fade |
| 68 | | Pixel 12 | 0-100% | 0-255 | 0 | Fade |

DMX Mode 4 (SPix Pro), 62 DMX Channels

Tilt, Beam shutter, special/control, Plates shutter, Plates grouped RGB, Plate individual pixel RGB, Beam individual pixel intensity

| Channel | Command | DMX range | Percent | Default DMX | Fade | |
|-------------------------------|--------------------------|--|---------|-------------|------|------|
| 1 | Coarse Tilt (MSB) | 0-185° | 0-255 | 0-100% | 127 | Fade |
| 2 | Fine Tilt (LSB) | Coarse tilt + 0-1.2° | 0-255 | 0-100% | 127 | Fade |
| 3 | Beam Intensity | Intensity 0-100% | 0-255 | 0-100% | 0 | Fade |
| 4 | Beam Duration | Flash duration 7-650 ms | 0-255 | 0-100% | 255 | Fade |
| 5 | Beam Rate | Flash rate 0.289-16.67 Hz | 0-255 | 0-100% | 255 | Fade |
| 6 | Beam Shutter | No effect | 0-36 | 0-14.0% | 0 | Snap |
| | | Ramp up (= fade on, snap off) | 37-40 | 14.5-15.5% | | |
| | | Ramp up random | 41-44 | 16.0-17.0% | | |
| | | Ramp down | 45-48 | 17.5-18.5% | | |
| | | Ramp down random | 49-52 | 19.0-20.0% | | |
| | | Ramp up down | 53-56 | 20.5-21.5% | | |
| | | Ramp up down random | 57-60 | 22.0-23.0% | | |
| | | Random white beam | 61-64 | 23.5-24.5% | | |
| | | Random single pixel of white beam | 65-68 | 25.0-26.0% | | |
| | | Lightning | 69-72 | 26.5-27.5% | | |
| | | Spikes (flash over low light) | 73-76 | 28.0-29.0% | | |
| | | White beam, left to right | 77-80 | 30.0-31.5% | | |
| | | White beam, left to right, random | 81-84 | 32.0-33.0% | | |
| | | White beam, right to left | 85-88 | 33.5-34.5% | | |
| | | White beam, right to left, random | 89-92 | 35.0-36.0% | | |
| | | White beam, left to right, bounce | 93-96 | 36.5-37.5% | | |
| | | White beam, left to right, bounce, random | 97-100 | 38.0-39.0% | | |
| | | White beam, right to left, bounce | 101-104 | 39.5-40.5% | | |
| | | White beam, right to left, bounce, random | 105-108 | 41.0-42.5% | | |
| | | Zig, 6 steps, outer to center pixels | 109-112 | 43.0-43.5% | | |
| | | Zig, 6 steps, outer to center pixels random | 113-116 | 44.0-45.5% | | |
| | | Zag, 6 steps, center to outer pixels | 117-120 | 46.0-47.0% | | |
| | | Zag, 6 steps, center to outer pixels, random | 121-124 | 47.5-48.5% | | |
| | | Zigzag, 10 steps | 125-128 | 49.0-50.0% | | |
| | | Zigzag, 10 steps, random | 129-132 | 50.5-52.0% | | |
| | | No function | 133-179 | 52.5-70.0% | | |
| | | Double flash | 180-183 | 70.6-71.8% | | |
| | | Double flash, random | 184-187 | 72.2-73.3% | | |
| | | Double flash, b-c (beam-color) | 188-191 | 73.7-74.9% | | |
| | | Double flash, b-c, random | 192-195 | 75.3-76.5% | | |
| | | Double flash, c-b (color-beam) | 196-199 | 76.9-78.0% | | |
| | | Double flash, c-b, random | 200-203 | 78.4-79.6% | | |
| Triple flash | 204-207 | 80.0-81.2% | | | | |
| Triple flash, random | 208-211 | 81.6-82.7% | | | | |
| Triple flash, beam-color-beam | 212-215 | 83.1-84.3% | | | | |
| Triple flash, b-c-b, random | 216-219 | 84.7-85.9% | | | | |
| Triple flash, c-b-c | 220-223 | 86.3-87.5% | | | | |
| Triple flash, c-b-c, random | 224-227 | 87.8-89.0% | | | | |

| | | | | | | |
|-------------|-----------------------------|--|---------|------------|---|------|
| 6 | Beam Shutter (continued) | Quad flash | 228-231 | 89.4-90.6% | | |
| | | Quad flash, random | 232-235 | 91.0-92.2% | | |
| | | Quad flash, b-c-b-c | 236-239 | 92.5-93.7% | | |
| | | Quad flash, b-c-b-c, random | 240-243 | 94.1-95.3% | | |
| | | Quad flash, c-b-c-b | 244-247 | 95.7-96.9% | | |
| | | Quad flash, c-b-c-b, random | 248-251 | 97.3-98.4% | | |
| | | No function | 252-255 | 98.5-100% | | |
| 7 | Special / Control | No function | 0 | 0% | 0 | Snap |
| | | Beam Shutter effects and FX patterns offset: | | | | |
| | | 10° | 1 | 0.4% | | |
| | | 20° | 2 | 0.8% | | |
| | | 30° | 3 | 1.2% | | |
| | | 40° | 4 | 1.6% | | |
| | | 50° | 5 | 2.0% | | |
| | | 60° | 6 | 2.4% | | |
| | | 70° | 7 | 2.8% | | |
| | | 80° | 8 | 3.1% | | |
| | | 90° | 9 | 3.5% | | |
| | | 100° | 10 | 3.9% | | |
| | | 110° | 11 | 4.3% | | |
| | | 120° | 12 | 4.7% | | |
| | | 130° | 13 | 5.1% | | |
| | | 140° | 14 | 5.5% | | |
| | | 150° | 15 | 5.9% | | |
| | | 160° | 16 | 6.3% | | |
| | | 170° | 17 | 6.7% | | |
| | | 180° | 18 | 7.1% | | |
| | | 190° | 19 | 7.5% | | |
| | | 200° | 20 | 7.8% | | |
| | | 210° | 21 | 8.2% | | |
| | | 220° | 22 | 8.6% | | |
| | | 230° | 23 | 9.0% | | |
| | | 240° | 24 | 9.4% | | |
| | | 250° | 25 | 9.8% | | |
| | | 260° | 26 | 10.2% | | |
| | | 270° | 27 | 10.6% | | |
| | | 280° | 28 | 11.0% | | |
| | | 290° | 29 | 11.4% | | |
| | | 300° | 30 | 11.8% | | |
| | | 310° | 31 | 12.2% | | |
| | | 320° | 32 | 12.6% | | |
| | | 330° | 33 | 12.9% | | |
| | | 340° | 34 | 13.3% | | |
| | | 350° | 35 | 13.7% | | |
| 360° | 36 | 14.1% | | | | |
| No function | 37-39 | 14.5-15.3% | | | | |

| | | | | | | |
|--------|--|--|---------|------------|--|--|
| 7 | Special / Control (continued) | Position feedback on* | 40-44 | 15.7-17.3% | | |
| | | Position feedback off* | 45-49 | 17.7-19.2% | | |
| | | Barndoor on* | 50-54 | 19.6-21.2% | | |
| | | Barndoor off* | 55-59 | 21.6-23.1% | | |
| | | No function | 60-61 | 23.5-23.9% | | |
| | | Tilt power on* | 62-63 | 24.3-24.7% | | |
| | | Tilt power off* | 64-65 | 25.1-25.5% | | |
| | | Tilt reset on* | 66-67 | 25.9-26.3% | | |
| | | Tilt reset off* | 68-69 | 26.7-27.1% | | |
| | | Normal tilt control* | 70-74 | 27.5-29.0% | | |
| | | Inverse tilt control* | 75-79 | 29.4-31.0% | | |
| | | Normal pixel numbering, plates 1+2 | 80-84 | 31.4-32.9% | | |
| | | Inverse pixel numbering, plates 1+2 | 85-89 | 33.3-34.9% | | |
| | | Normal pixel numbering, 2nd plate | 90-94 | 35.3-36.9% | | |
| | | Inverse pixel numbering, 2nd plate | 95-99 | 37.3-38.8% | | |
| | | Linear dimming curve | 100-101 | 39.2-39.6% | | |
| | | Soft dimming curve | 102-103 | 40.0-40.4% | | |
| | | Extra-soft dimming curve | 104-105 | 40.8-41.2% | | |
| | | No function | 106-120 | 41.6-47.1% | | |
| | | PWM frequency (hold value for >3 seconds): | | | | |
| | | 582 Hz | 121-122 | 47.5-47.8% | | |
| | | 583 Hz | 123-124 | 48.2-48.6% | | |
| | | 584 Hz | 125-126 | 49.0-49.4% | | |
| | | 585 Hz | 127-128 | 49.8-50.2% | | |
| | | 586 Hz | 129-130 | 50.6-51.0% | | |
| | | 587 Hz | 131-132 | 51.4-51.8% | | |
| | | 588 Hz | 133-134 | 52.2-52.5% | | |
| | | 589 Hz | 135-136 | 52.9-53.3% | | |
| | | 590 Hz | 137-138 | 53.7-54.1% | | |
| | | 591 Hz | 139-140 | 54.5-54.9% | | |
| | | 592 Hz | 141-142 | 55.3-55.7% | | |
| | | 593 Hz | 143-144 | 56.1-56.5% | | |
| | | 594 Hz | 145-146 | 56.9-57.3% | | |
| | | 595 Hz | 147-148 | 57.6-58.0% | | |
| | | 596 Hz | 149-150 | 58.4-58.8% | | |
| | | 597 Hz | 151-152 | 59.2-59.6% | | |
| | | 598 Hz | 153-154 | 60.0-60.4% | | |
| | | 599 Hz | 155-156 | 60.8-61.2% | | |
| | | 600 Hz | 157-158 | 61.6-62.0% | | |
| | | 601 Hz | 159-160 | 62.4-62.7% | | |
| | | 602 Hz | 161-162 | 63.1-63.5% | | |
| | | 603 Hz | 163-164 | 63.9-64.3% | | |
| | | 604 Hz | 165-166 | 64.7-65.1% | | |
| | | 605 Hz | 167-168 | 65.5-65.9% | | |
| | | 606 Hz | 169-170 | 66.3-66.7% | | |
| | | 607 Hz | 171-172 | 67.1-67.5% | | |
| | | 608 Hz | 173-174 | 67.8-68.2% | | |
| 609 Hz | 175-176 | 68.6-69.0% | | | | |
| 610 Hz | 177-178 | 69.4-69.8% | | | | |
| 611 Hz | 179-180 | 70.2-70.6% | | | | |

| | | | | | | |
|--|---|---|---------|------------|-----|------|
| 7 | Special /Control (continued) | 612 Hz | 181-182 | 71.0-71.4% | | |
| | | 613 Hz | 183-184 | 71.8-72.2% | | |
| | | 614 Hz | 185-186 | 72.5-72.9% | | |
| | | 615 Hz | 187-188 | 73.3-73.7% | | |
| | | 616 Hz | 189-190 | 74.1-74.5% | | |
| | | 617 Hz | 191-192 | 74.9-75.3% | | |
| | | 618 Hz | 193-194 | 75.6-76.1% | | |
| | | 1200 Hz | 195-197 | 76.5-77.3% | | |
| | | 2400 Hz | 198-200 | 77.6-78.4% | | |
| | | Fan mode = Auto | 201-204 | 78.8-80.0% | | |
| | | Fan mode = High | 205-209 | 80.4-82.0% | | |
| | | Percentage flash mode (hold for >0.5 sec.) | 210-214 | 82.5-84.0% | | |
| | | Normal flash mode (hold for >0.5 sec.) | 215-219 | 84.5-85.0% | | |
| | | Dimmer flash mode on* | 220-224 | 86.0-87.5% | | |
| | | Dimmer flash mode off* | 225-229 | 88.0-90.0% | | |
| | | FX color priority = Beam* | 230-233 | 90.5-91.4% | | |
| | | FX color priority = Mixed* | 234-236 | 91.8-92.5% | | |
| | | FX color priority = Plate* | 237-239 | 92.9-93.7% | | |
| Aggressive flash mode (hold for >0.5 sec.) | 240-244 | 94.1-95.7% | | | | |
| No function | 245-247 | 96.1-96.9% | | | | |
| Reset (hold value for >5 sec.) | 248-255 | 97.3-100% | | | | |
| 8 | Plate Intensity | Intensity 0-100% | 0-255 | 0-100% | 0 | Fade |
| 9 | Plate Flash Duration | 7-650 ms | 0-255 | 0-100% | 255 | Fade |
| 10 | Plate Flash Rate | 0.289-16.67 Hz | 0-255 | 0-100% | 255 | Fade |
| 11 | Plate Shutter | No function | 0 | 0% | 0 | Snap |
| | | Plate Shutter effects and FX patterns offset: | | | | |
| | | 10° | 1 | 0.4% | | |
| | | 20° | 2 | 0.8% | | |
| | | 30° | 3 | 1.2% | | |
| | | 40° | 4 | 1.6% | | |
| | | 50° | 5 | 2.0% | | |
| | | 60° | 6 | 2.4% | | |
| | | 70° | 7 | 2.8% | | |
| | | 80° | 8 | 3.1% | | |
| | | 90° | 9 | 3.5% | | |
| | | 100° | 10 | 3.9% | | |
| | | 110° | 11 | 4.3% | | |
| | | 120° | 12 | 4.7% | | |
| | | 130° | 13 | 5.1% | | |
| | | 140° | 14 | 5.5% | | |
| | | 150° | 15 | 5.9% | | |
| | | 160° | 16 | 6.3% | | |
| | | 170° | 17 | 6.7% | | |
| | | 180° | 18 | 7.1% | | |
| | | 190° | 19 | 7.5% | | |
| | | 200° | 20 | 7.8% | | |
| 210° | 21 | 8.2% | | | | |
| 220° | 22 | 8.6% | | | | |

| | | | | | | |
|----------------------|------------------------------|------------------------------------|---------|------------|-----|------|
| 11 | Plate Shutter (continued) | 240° | 24 | 9.4% | | |
| | | 250° | 25 | 9.8% | | |
| | | 260° | 26 | 10.2% | | |
| | | 270° | 27 | 10.6% | | |
| | | 280° | 28 | 11.0% | | |
| | | 290° | 29 | 11.4% | | |
| | | 300° | 30 | 11.8% | | |
| | | 310° | 31 | 12.2% | | |
| | | 320° | 32 | 12.6% | | |
| | | 330° | 33 | 12.9% | | |
| | | 340° | 34 | 13.3% | | |
| | | 350° | 35 | 13.7% | | |
| | | 360° | 36 | 14.1% | | |
| | | Ramp up (fade on, snap off) | 37-40 | 14.5-15.5% | | |
| | | Ramp up, random | 41-44 | 16.0-17.0% | | |
| | | Ramp down | 45-48 | 17.5-18.5% | | |
| | | Ramp down, random | 49-52 | 19.0-20.0% | | |
| | | Ramp up / down | 53-56 | 20.5-21.5% | | |
| | | Ramp up / down, random | 57-60 | 22.0-23.0% | | |
| | | Random white beam | 61-64 | 23.5-24.5% | | |
| | | Random single pixel of white beam | 65-68 | 25.0-26.0% | | |
| | | Lightning | 69-72 | 26.5-27.5% | | |
| | | Spikes (flash over low light) | 73-76 | 28.0-29.0% | | |
| | | No function | 77-179 | 29.5-70.0% | | |
| | | Double flash | 180-191 | 70.6-74.9% | | |
| Double flash, random | 192-203 | 75.3-79.6% | | | | |
| Triple flash | 204-215 | 80.0-84.3% | | | | |
| Triple flash, random | 216-227 | 84.7-89.0% | | | | |
| Quad flash | 228-239 | 89.4-93.7% | | | | |
| Quad flash, random | 240-251 | 94.1-98.4% | | | | |
| No effect | 252-255 | 98.5-100% | | | | |
| 12 | Plates Red | Both plates red intensity 0-100% | 0-255 | 0-100% | 255 | Fade |
| 13 | Plates Green | Both plates green intensity 0-100% | 0-255 | 0-100% | 255 | Fade |
| 14 | Plates Blue | Both plates blue intensity 0-100% | 0-255 | 0-100% | 255 | Fade |
| 15 | Plate Pixel 1 | Red intensity 0-100% | 0-100% | 0-255 | 0 | Fade |
| 16 | | Green intensity 0-100% | 0-100% | 0-255 | 0 | Fade |
| 17 | | Blue intensity 0-100% | 0-100% | 0-255 | 0 | Fade |
| 18 | Plate Pixel 2 | Red intensity 0-100% | 0-100% | 0-255 | 0 | Fade |
| 19 | | Green intensity 0-100% | 0-100% | 0-255 | 0 | Fade |
| 20 | | Blue intensity 0-100% | 0-100% | 0-255 | 0 | Fade |
| 21 | Plate Pixel 3 | Red intensity 0-100% | 0-100% | 0-255 | 0 | Fade |
| 22 | | Green intensity 0-100% | 0-100% | 0-255 | 0 | Fade |
| 23 | | Blue intensity 0-100% | 0-100% | 0-255 | 0 | Fade |
| 24 | Plate Pixel 4 | Red intensity 0-100% | 0-100% | 0-255 | 0 | Fade |
| 25 | | Green intensity 0-100% | 0-100% | 0-255 | 0 | Fade |
| 26 | | Blue intensity 0-100% | 0-100% | 0-255 | 0 | Fade |
| 27 | Plate Pixel 5 | Red intensity 0-100% | 0-100% | 0-255 | 0 | Fade |
| 28 | | Green intensity 0-100% | 0-100% | 0-255 | 0 | Fade |
| 29 | | Blue intensity 0-100% | 0-100% | 0-255 | 0 | Fade |
| 30 | Plate Pixel 6 | Red intensity 0-100% | 0-100% | 0-255 | 0 | Fade |
| 31 | | Green intensity 0-100% | 0-100% | 0-255 | 0 | Fade |
| 32 | | Blue intensity 0-100% | 0-100% | 0-255 | 0 | Fade |

| | | | | | | |
|-----------|-----------------------|---------------------------|--------|-------|---|------|
| 33 | Plate Pixel 7 | Red intensity 0-100% | 0-100% | 0-255 | 0 | Fade |
| 34 | | Green intensity 0-100% | 0-100% | 0-255 | 0 | Fade |
| 35 | | Blue intensity 0-100% | 0-100% | 0-255 | 0 | Fade |
| 36 | Plate Pixel 8 | Red intensity 0-100% | 0-100% | 0-255 | 0 | Fade |
| 37 | | Green intensity 0-100% | 0-100% | 0-255 | 0 | Fade |
| 38 | | Blue intensity 0-100% | 0-100% | 0-255 | 0 | Fade |
| 39 | Plate Pixel 9 | Red intensity 0-100% | 0-100% | 0-255 | 0 | Fade |
| 40 | | Green intensity 0-100% | 0-100% | 0-255 | 0 | Fade |
| 41 | | Blue intensity 0-100% | 0-100% | 0-255 | 0 | Fade |
| 42 | Plate Pixel 10 | Red intensity 0-100% | 0-100% | 0-255 | 0 | Fade |
| 43 | | Green intensity 0-100% | 0-100% | 0-255 | 0 | Fade |
| 44 | | Blue intensity 0-100% | 0-100% | 0-255 | 0 | Fade |
| 45 | Plate Pixel 11 | Red intensity 0-100% | 0-100% | 0-255 | 0 | Fade |
| 46 | | Green intensity 0-100% | 0-100% | 0-255 | 0 | Fade |
| 47 | | Blue intensity 0-100% | 0-100% | 0-255 | 0 | Fade |
| 48 | Plate Pixel 12 | Red intensity 0-100% | 0-100% | 0-255 | 0 | Fade |
| 49 | | Green intensity 0-100% | 0-100% | 0-255 | 0 | Fade |
| 50 | | Blue intensity 0-100% | 0-100% | 0-255 | 0 | Fade |
| 51 | Beam Pixels | Pixel 1 intensity 0-100% | 0-100% | 0-255 | 0 | Fade |
| 52 | | Pixel 2 intensity 0-100% | 0-100% | 0-255 | 0 | Fade |
| 53 | | Pixel 3 intensity 0-100% | 0-100% | 0-255 | 0 | Fade |
| 54 | | Pixel 4 intensity 0-100% | 0-100% | 0-255 | 0 | Fade |
| 55 | | Pixel 5 intensity 0-100% | 0-100% | 0-255 | 0 | Fade |
| 56 | | Pixel 6 intensity 0-100% | 0-100% | 0-255 | 0 | Fade |
| 57 | | Pixel 7 intensity 0-100% | 0-100% | 0-255 | 0 | Fade |
| 58 | | Pixel 8 intensity 0-100% | 0-100% | 0-255 | 0 | Fade |
| 59 | | Pixel 9 intensity 0-100% | 0-100% | 0-255 | 0 | Fade |
| 60 | | Pixel 10 intensity 0-100% | 0-100% | 0-255 | 0 | Fade |
| 61 | | Pixel 11 intensity 0-100% | 0-100% | 0-255 | 0 | Fade |
| 62 | | Pixel 12 intensity 0-100% | 0-100% | 0-255 | 0 | Fade |

DMX Mode 5 (1Pix Pro), 17 DMX Channels

Tilt, Beam shutter, special/control, Plates shutter, Plates grouped RGB, Plates background grouped RGB

| Channel | Command | DMX range | Percent | Default DMX | Fade | |
|-------------------------------|--------------------------|--|---------|-------------|------|------|
| 1 | Coarse Tilt (MSB) | 0-185° | 0-255 | 0-100% | 127 | Fade |
| 2 | Fine Tilt (LSB) | Coarse tilt + 0-1.2° | 0-255 | 0-100% | 127 | Fade |
| 3 | Beam Intensity | Intensity 0-100% | 0-255 | 0-100% | 0 | Fade |
| 4 | Beam Duration | Flash duration 7-650 ms | 0-255 | 0-100% | 255 | Fade |
| 5 | Beam Rate | Flash rate 0.289-16.67 Hz | 0-255 | 0-100% | 255 | Fade |
| 6 | Beam Shutter | No effect | 0-36 | 0-14.0% | 0 | Snap |
| | | Ramp up (= fade on, snap off) | 37-40 | 14.5-15.5% | | |
| | | Ramp up random | 41-44 | 16.0-17.0% | | |
| | | Ramp down | 45-48 | 17.5-18.5% | | |
| | | Ramp down random | 49-52 | 19.0-20.0% | | |
| | | Ramp up down | 53-56 | 20.5-21.5% | | |
| | | Ramp up down random | 57-60 | 22.0-23.0% | | |
| | | Random white beam | 61-64 | 23.5-24.5% | | |
| | | Random single pixel of white beam | 65-68 | 25.0-26.0% | | |
| | | Lightning | 69-72 | 26.5-27.5% | | |
| | | Spikes (flash over low light) | 73-76 | 28.0-29.0% | | |
| | | White beam, left to right | 77-80 | 30.0-31.5% | | |
| | | White beam, left to right, random | 81-84 | 32.0-33.0% | | |
| | | White beam, right to left | 85-88 | 33.5-34.5% | | |
| | | White beam, right to left, random | 89-92 | 35.0-36.0% | | |
| | | White beam, left to right, bounce | 93-96 | 36.5-37.5% | | |
| | | White beam, left to right, bounce, random | 97-100 | 38.0-39.0% | | |
| | | White beam, right to left, bounce | 101-104 | 39.5-40.5% | | |
| | | White beam, right to left, bounce, random | 105-108 | 41.0-42.5% | | |
| | | Zig, 6 steps, outer to center pixels | 109-112 | 43.0-43.5% | | |
| | | Zig, 6 steps, outer to center pixels random | 113-116 | 44.0-45.5% | | |
| | | Zag, 6 steps, center to outer pixels | 117-120 | 46.0-47.0% | | |
| | | Zag, 6 steps, center to outer pixels, random | 121-124 | 47.5-48.5% | | |
| | | Zigzag, 10 steps | 125-128 | 49.0-50.0% | | |
| | | Zigzag, 10 steps, random | 129-132 | 50.5-52.0% | | |
| | | No function | 133-179 | 52.5-70.0% | | |
| | | Double flash | 180-183 | 70.6-71.8% | | |
| | | Double flash, random | 184-187 | 72.2-73.3% | | |
| | | Double flash, b-c (beam-color) | 188-191 | 73.7-74.9% | | |
| | | Double flash, b-c, random | 192-195 | 75.3-76.5% | | |
| | | Double flash, c-b (color-beam) | 196-199 | 76.9-78.0% | | |
| Double flash, c-b, random | 200-203 | 78.4-79.6% | | | | |
| Triple flash | 204-207 | 80.0-81.2% | | | | |
| Triple flash, random | 208-211 | 81.6-82.7% | | | | |
| Triple flash, beam-color-beam | 212-215 | 83.1-84.3% | | | | |
| Triple flash, b-c-b, random | 216-219 | 84.7-85.9% | | | | |
| Triple flash, c-b-c | 220-223 | 86.3-87.5% | | | | |
| Triple flash, c-b-c, random | 224-227 | 87.8-89.0% | | | | |

| | | | | | | |
|-------------|-----------------------------|--|---------|------------|---|------|
| 6 | Beam Shutter (continued) | Quad flash | 228-231 | 89.4-90.6% | | |
| | | Quad flash, random | 232-235 | 91.0-92.2% | | |
| | | Quad flash, b-c-b-c | 236-239 | 92.5-93.7% | | |
| | | Quad flash, b-c-b-c, random | 240-243 | 94.1-95.3% | | |
| | | Quad flash, c-b-c-b | 244-247 | 95.7-96.9% | | |
| | | Quad flash, c-b-c-b, random | 248-251 | 97.3-98.4% | | |
| | | No function | 252-255 | 98.5-100% | | |
| 7 | Special / Control | No function | 0 | 0% | 0 | Snap |
| | | Beam Shutter effects and FX patterns offset: | | | | |
| | | 10° | 1 | 0.4% | | |
| | | 20° | 2 | 0.8% | | |
| | | 30° | 3 | 1.2% | | |
| | | 40° | 4 | 1.6% | | |
| | | 50° | 5 | 2.0% | | |
| | | 60° | 6 | 2.4% | | |
| | | 70° | 7 | 2.8% | | |
| | | 80° | 8 | 3.1% | | |
| | | 90° | 9 | 3.5% | | |
| | | 100° | 10 | 3.9% | | |
| | | 110° | 11 | 4.3% | | |
| | | 120° | 12 | 4.7% | | |
| | | 130° | 13 | 5.1% | | |
| | | 140° | 14 | 5.5% | | |
| | | 150° | 15 | 5.9% | | |
| | | 160° | 16 | 6.3% | | |
| | | 170° | 17 | 6.7% | | |
| | | 180° | 18 | 7.1% | | |
| | | 190° | 19 | 7.5% | | |
| | | 200° | 20 | 7.8% | | |
| | | 210° | 21 | 8.2% | | |
| | | 220° | 22 | 8.6% | | |
| | | 230° | 23 | 9.0% | | |
| | | 240° | 24 | 9.4% | | |
| | | 250° | 25 | 9.8% | | |
| | | 260° | 26 | 10.2% | | |
| | | 270° | 27 | 10.6% | | |
| | | 280° | 28 | 11.0% | | |
| | | 290° | 29 | 11.4% | | |
| | | 300° | 30 | 11.8% | | |
| | | 310° | 31 | 12.2% | | |
| | | 320° | 32 | 12.6% | | |
| | | 330° | 33 | 12.9% | | |
| | | 340° | 34 | 13.3% | | |
| | | 350° | 35 | 13.7% | | |
| 360° | 36 | 14.1% | | | | |
| No function | 37-39 | 14.5-15.3% | | | | |

| | | | | | | |
|--------|----------------------------------|--|---------|------------|--|--|
| 7 | Special / Control (continued) | Position feedback on* | 40-44 | 15.7-17.3% | | |
| | | Position feedback off* | 45-49 | 17.7-19.2% | | |
| | | Barndoor on* | 50-54 | 19.6-21.2% | | |
| | | Barndoor off* | 55-59 | 21.6-23.1% | | |
| | | No function | 60-61 | 23.5-23.9% | | |
| | | Tilt power on* | 62-63 | 24.3-24.7% | | |
| | | Tilt power off* | 64-65 | 25.1-25.5% | | |
| | | Tilt reset on* | 66-67 | 25.9-26.3% | | |
| | | Tilt reset off* | 68-69 | 26.7-27.1% | | |
| | | Normal tilt control* | 70-74 | 27.5-29.0% | | |
| | | Inverse tilt control* | 75-79 | 29.4-31.0% | | |
| | | Normal pixel numbering, plates 1+2 | 80-84 | 31.4-32.9% | | |
| | | Inverse pixel numbering, plates 1+2 | 85-89 | 33.3-34.9% | | |
| | | Normal pixel numbering, 2nd plate | 90-94 | 35.3-36.9% | | |
| | | Inverse pixel numbering, 2nd plate | 95-99 | 37.3-38.8% | | |
| | | Linear dimming curve | 100-101 | 39.2-39.6% | | |
| | | Soft dimming curve | 102-103 | 40.0-40.4% | | |
| | | Extra-soft dimming curve | 104-105 | 40.8-41.2% | | |
| | | No function | 106-120 | 41.6-47.1% | | |
| | | PWM frequency (hold value for >3 seconds): | | | | |
| | | 582 Hz | 121-122 | 47.5-47.8% | | |
| | | 583 Hz | 123-124 | 48.2-48.6% | | |
| | | 584 Hz | 125-126 | 49.0-49.4% | | |
| | | 585 Hz | 127-128 | 49.8-50.2% | | |
| | | 586 Hz | 129-130 | 50.6-51.0% | | |
| | | 587 Hz | 131-132 | 51.4-51.8% | | |
| | | 588 Hz | 133-134 | 52.2-52.5% | | |
| | | 589 Hz | 135-136 | 52.9-53.3% | | |
| | | 590 Hz | 137-138 | 53.7-54.1% | | |
| | | 591 Hz | 139-140 | 54.5-54.9% | | |
| | | 592 Hz | 141-142 | 55.3-55.7% | | |
| | | 593 Hz | 143-144 | 56.1-56.5% | | |
| | | 594 Hz | 145-146 | 56.9-57.3% | | |
| | | 595 Hz | 147-148 | 57.6-58.0% | | |
| | | 596 Hz | 149-150 | 58.4-58.8% | | |
| | | 597 Hz | 151-152 | 59.2-59.6% | | |
| | | 598 Hz | 153-154 | 60.0-60.4% | | |
| | | 599 Hz | 155-156 | 60.8-61.2% | | |
| | | 600 Hz | 157-158 | 61.6-62.0% | | |
| | | 601 Hz | 159-160 | 62.4-62.7% | | |
| | | 602 Hz | 161-162 | 63.1-63.5% | | |
| | | 603 Hz | 163-164 | 63.9-64.3% | | |
| | | 604 Hz | 165-166 | 64.7-65.1% | | |
| | | 605 Hz | 167-168 | 65.5-65.9% | | |
| | | 606 Hz | 169-170 | 66.3-66.7% | | |
| | | 607 Hz | 171-172 | 67.1-67.5% | | |
| | | 608 Hz | 173-174 | 67.8-68.2% | | |
| 609 Hz | 175-176 | 68.6-69.0% | | | | |
| 610 Hz | 177-178 | 69.4-69.8% | | | | |
| 611 Hz | 179-180 | 70.2-70.6% | | | | |

| | | | | | | |
|--|---|---|---------|------------|-----|------|
| 7 | Special /Control (continued) | 612 Hz | 181-182 | 71.0-71.4% | | |
| | | 613 Hz | 183-184 | 71.8-72.2% | | |
| | | 614 Hz | 185-186 | 72.5-72.9% | | |
| | | 615 Hz | 187-188 | 73.3-73.7% | | |
| | | 616 Hz | 189-190 | 74.1-74.5% | | |
| | | 617 Hz | 191-192 | 74.9-75.3% | | |
| | | 618 Hz | 193-194 | 75.6-76.1% | | |
| | | 1200 Hz | 195-197 | 76.5-77.3% | | |
| | | 2400 Hz | 198-200 | 77.6-78.4% | | |
| | | Fan mode = Auto | 201-204 | 78.8-80.0% | | |
| | | Fan mode = High | 205-209 | 80.4-82.0% | | |
| | | Percentage flash mode (hold for >0.5 sec.) | 210-214 | 82.5-84.0% | | |
| | | Normal flash mode (hold for >0.5 sec.) | 215-219 | 84.5-85.0% | | |
| | | Dimmer flash mode on* | 220-224 | 86.0-87.5% | | |
| | | Dimmer flash mode off* | 225-229 | 88.0-90.0% | | |
| | | FX color priority = Beam* | 230-233 | 90.5-91.4% | | |
| | | FX color priority = Mixed* | 234-236 | 91.8-92.5% | | |
| | | FX color priority = Plate* | 237-239 | 92.9-93.7% | | |
| Aggressive flash mode (hold for >0.5 sec.) | 240-244 | 94.1-95.7% | | | | |
| No function | 245-247 | 96.1-96.9% | | | | |
| Reset (hold value for >5 sec.) | 248-255 | 97.3-100% | | | | |
| 8 | Plate Intensity | Intensity 0-100% | 0-255 | 0-100% | 0 | Fade |
| 9 | Plate Flash Duration | 7-650 ms | 0-255 | 0-100% | 255 | Fade |
| 10 | Plate Flash Rate | 0.289-16.67 Hz | 0-255 | 0-100% | 255 | Fade |
| 11 | Plate Shutter | No function | 0 | 0% | 0 | Snap |
| | | Plate Shutter effects and FX patterns offset: | | | | |
| | | 10° | 1 | 0.4% | | |
| | | 20° | 2 | 0.8% | | |
| | | 30° | 3 | 1.2% | | |
| | | 40° | 4 | 1.6% | | |
| | | 50° | 5 | 2.0% | | |
| | | 60° | 6 | 2.4% | | |
| | | 70° | 7 | 2.8% | | |
| | | 80° | 8 | 3.1% | | |
| | | 90° | 9 | 3.5% | | |
| | | 100° | 10 | 3.9% | | |
| | | 110° | 11 | 4.3% | | |
| | | 120° | 12 | 4.7% | | |
| | | 130° | 13 | 5.1% | | |
| | | 140° | 14 | 5.5% | | |
| | | 150° | 15 | 5.9% | | |
| | | 160° | 16 | 6.3% | | |
| | | 170° | 17 | 6.7% | | |
| | | 180° | 18 | 7.1% | | |
| | | 190° | 19 | 7.5% | | |
| | | 200° | 20 | 7.8% | | |
| | | 210° | 21 | 8.2% | | |
| 220° | 22 | 8.6% | | | | |

| | | | | | | |
|----------------------|----------------------------------|------------------------------------|---------|------------|-----|------|
| 11 | Plate Shutter (continued) | 240° | 24 | 9.4% | | |
| | | 250° | 25 | 9.8% | | |
| | | 260° | 26 | 10.2% | | |
| | | 270° | 27 | 10.6% | | |
| | | 280° | 28 | 11.0% | | |
| | | 290° | 29 | 11.4% | | |
| | | 300° | 30 | 11.8% | | |
| | | 310° | 31 | 12.2% | | |
| | | 320° | 32 | 12.6% | | |
| | | 330° | 33 | 12.9% | | |
| | | 340° | 34 | 13.3% | | |
| | | 350° | 35 | 13.7% | | |
| | | 360° | 36 | 14.1% | | |
| | | Ramp up (fade on, snap off) | 37-40 | 14.5-15.5% | | |
| | | Ramp up, random | 41-44 | 16.0-17.0% | | |
| | | Ramp down | 45-48 | 17.5-18.5% | | |
| | | Ramp down, random | 49-52 | 19.0-20.0% | | |
| | | Ramp up / down | 53-56 | 20.5-21.5% | | |
| | | Ramp up / down, random | 57-60 | 22.0-23.0% | | |
| | | Random white beam | 61-64 | 23.5-24.5% | | |
| | | Random single pixel of white beam | 65-68 | 25.0-26.0% | | |
| | | Lightning | 69-72 | 26.5-27.5% | | |
| | | Spikes (flash over low light) | 73-76 | 28.0-29.0% | | |
| | | No function | 77-179 | 29.5-70.0% | | |
| | | Double flash | 180-191 | 70.6-74.9% | | |
| Double flash, random | 192-203 | 75.3-79.6% | | | | |
| Triple flash | 204-215 | 80.0-84.3% | | | | |
| Triple flash, random | 216-227 | 84.7-89.0% | | | | |
| Quad flash | 228-239 | 89.4-93.7% | | | | |
| Quad flash, random | 240-251 | 94.1-98.4% | | | | |
| No effect | 252-255 | 98.5-100% | | | | |
| 12 | Plates Red | Both plates red intensity 0-100% | 0-255 | 0-100% | 255 | Fade |
| 13 | Plates Green | Both plates green intensity 0-100% | 0-255 | 0-100% | 255 | Fade |
| 14 | Plates Blue | Both plates blue intensity 0-100% | 0-255 | 0-100% | 255 | Fade |
| 15 | Plates Flash Background Red | Intensity 0-100% | 0-255 | 0-100% | 0 | Fade |
| 16 | Plates Flash Background Green | Intensity 0-100% | 0-255 | 0-100% | 0 | Fade |
| 17 | Plates Flash Background Blue | Intensity 0-100% | 0-255 | 0-100% | 0 | Fade |

9. Plate FX patterns

You can display the following dynamic patterns on the Plates in DMX modes 2 and 3 by sending the indicated DMX values on channel 17:



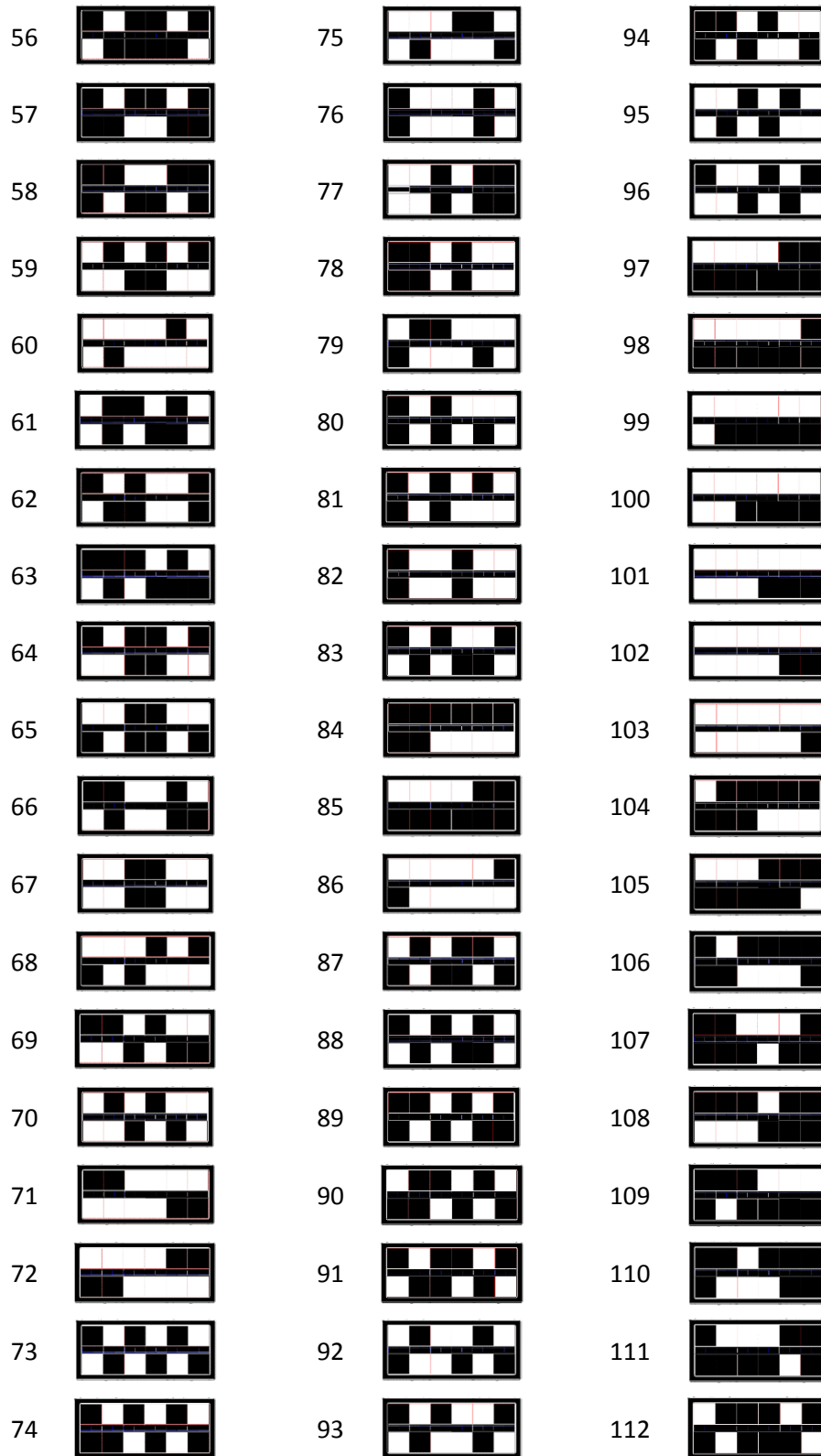

| | | | | | |
|-----|--|-----|--|-----|--|
| 113 | | 132 | | 151 | |
| 114 | | 133 | | 152 | |
| 115 | | 134 | | 153 | |
| 116 | | 135 | | 154 | |
| 117 | | 136 | | 155 | |
| 118 | | 137 | | 156 | |
| 119 | | 138 | | 157 | |
| 120 | | 139 | | 158 | |
| 121 | | 140 | | 159 | |
| 122 | | 141 | | 160 | |
| 123 | | 142 | | 161 | |
| 124 | | 143 | | 162 | |
| 125 | | 144 | | 163 | |
| 126 | | 145 | | 164 | |
| 127 | | 146 | | 165 | |
| 128 | | 147 | | 166 | |
| 129 | | 148 | | 167 | |
| 130 | | 149 | | 168 | |
| 131 | | 150 | | 169 | |

| | | | | | |
|---------|--|-----|--|-----|--|
| 170 | | 191 | | 210 | |
| 171 | | 192 | | 211 | |
| 172 | | 193 | | 212 | |
| 173 | | 194 | | 213 | |
| 174 | | 195 | | 214 | |
| 175 | | 196 | | 215 | |
| 176 | | 197 | | 216 | |
| 177 | | 198 | | 217 | |
| 178-180 | | 199 | | 218 | |
| 181 | | 200 | | 219 | |
| 182 | | 201 | | 220 | |
| 183 | | 202 | | 221 | |
| 184 | | 203 | | 222 | |
| 185 | | 204 | | 223 | |
| 186 | | 205 | | 224 | |
| 187 | | 206 | | 225 | |
| 188 | | 207 | | 226 | |
| 189 | | 208 | | 227 | |
| 190 | | 209 | | 228 | |

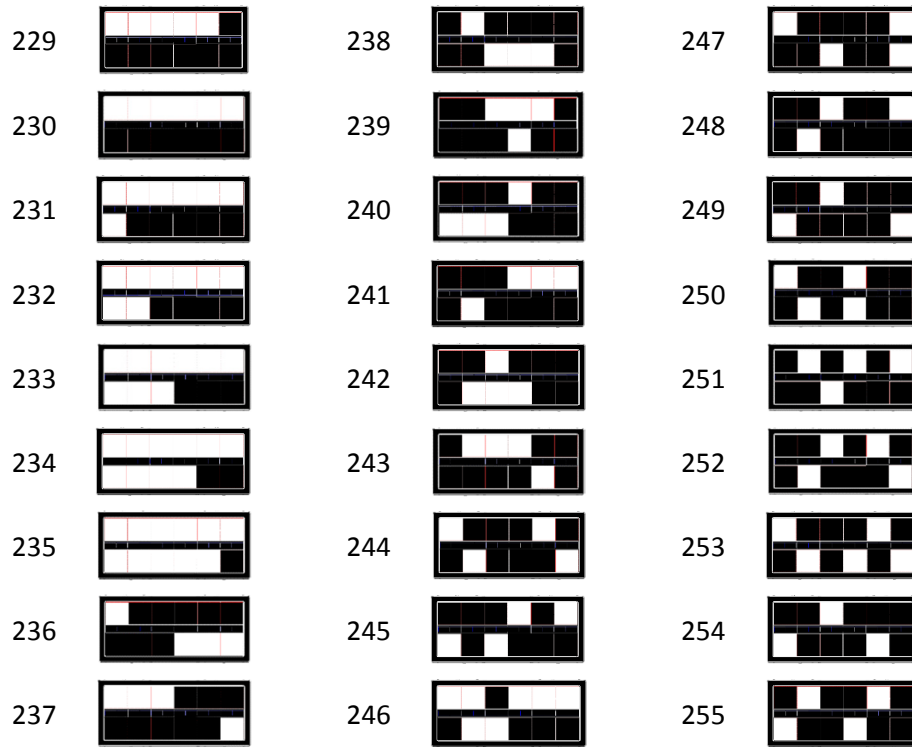

10. Beam FX patterns

You can display the following dynamic patterns on the Beam pixels in DMX modes 2 and 3 by sending the indicated DMX values on channel 19:

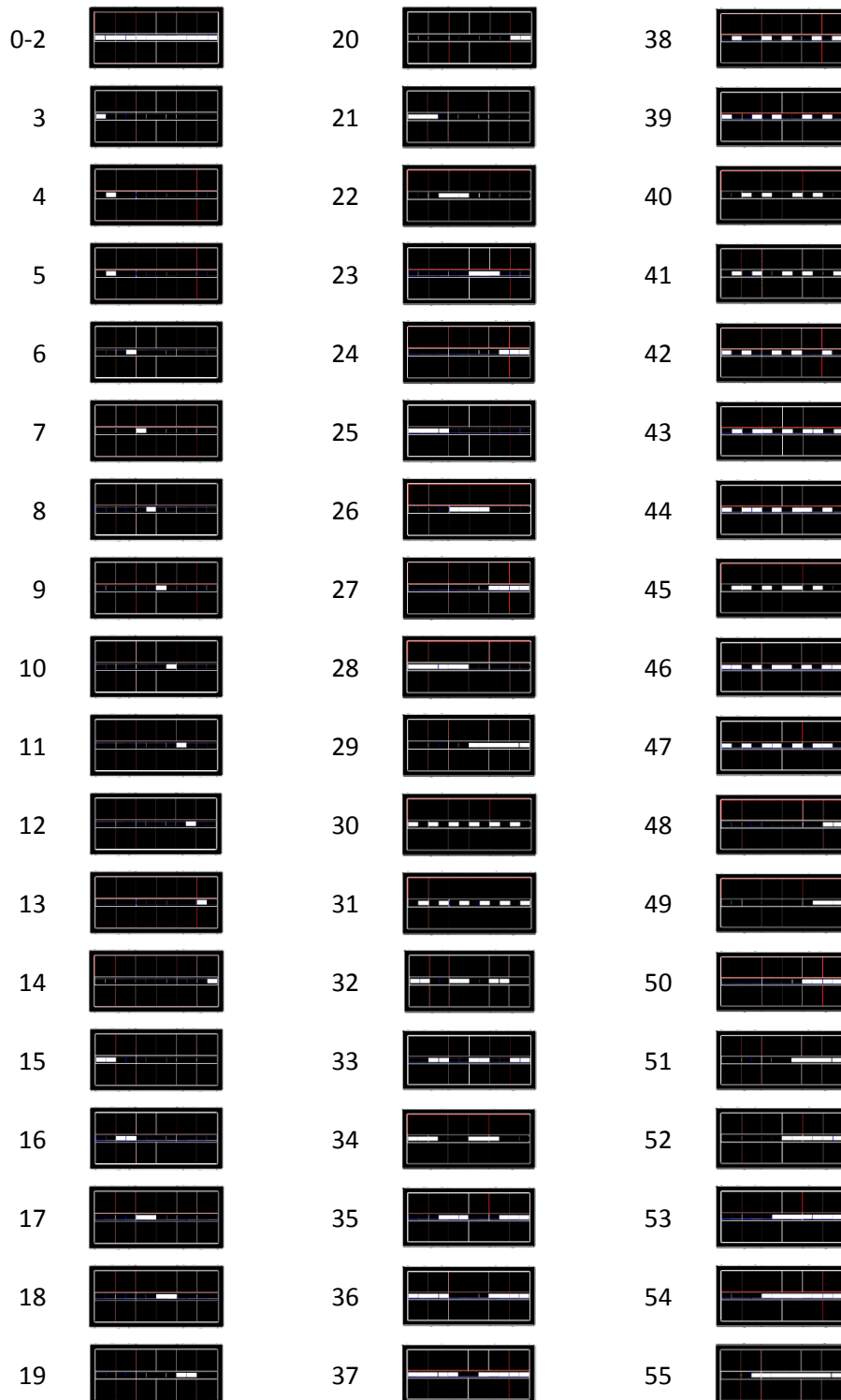

| | | | | | |
|----|--|----|--|-----|--|
| 56 | | 76 | | 96 | |
| 57 | | 77 | | 97 | |
| 58 | | 78 | | 98 | |
| 59 | | 79 | | 99 | |
| 60 | | 80 | | 100 | |
| 61 | | 81 | | 101 | |
| 62 | | 82 | | 102 | |
| 63 | | 83 | | 103 | |
| 64 | | 84 | | 104 | |
| 65 | | 85 | | 105 | |
| 66 | | 86 | | 106 | |
| 67 | | 87 | | 107 | |
| 68 | | 88 | | 108 | |
| 69 | | 89 | | 109 | |
| 70 | | 90 | | 110 | |
| 71 | | 91 | | 111 | |
| 72 | | 92 | | 112 | |
| 73 | | 93 | | 113 | |
| 74 | | 94 | | 114 | |
| 75 | | 95 | | 115 | |

| | | | | | |
|-----|--|---------|--|---------|--|
| 116 | | 130 | | 157 | |
| 117 | | 131 | | 158-160 | |
| 118 | | 132 | | 161 | |
| 119 | | 133 | | 162-164 | |
| 120 | | 134 | | 165 | |
| 121 | | 135-145 | | 166-255 | |
| 122 | | 146 | | | |
| 123 | | 147-149 | | | |
| 124 | | 150 | | | |
| 125 | | 151 | | | |
| 126 | | 152 | | | |
| 127 | | 153-154 | | | |
| 128 | | 155 | | | |
| 129 | | 156 | | | |

11. Cleaning and maintenance



WARNING! Any service operation that requires removal of a cover must be performed by a professional service technician with the necessary tools, skills and personal protective equipment to maintain high-powered lighting equipment safely and efficiently.

Suggested maintenance intervals

The cleaning schedule depends on the operating environment. The intervals below are suggestions from our experience with typical installations. Adjust as necessary.

| Maintenance task | Interval | How |
|----------------------|----------|--------------------------------------|
| Front glass | Weekly | Soft cloth and glass cleaning fluid |
| Fans and air channel | Monthly | Vacuum cleaner, compressed air, etc. |
| Moveable parts | Yearly | Suitable lubricant |

Cleaning

JDC1 components require occasional cleaning to prevent the buildup of dust, dirt, and smoke fluid residue. Pay special attention to the air vents and glass plate. Failure to keep the fixture clean will significantly reduce light output and may cause damage. Regular cleaning will ensure maximum performance and reliable operation.

You can clean the front glass with household or automotive glass cleaning products.

GLP Service and Support

Contact information for the nearest GLP Service and Support is available online at www.glp.de/en/service, by email at info@glp.de, or by telephone at the following numbers:

- GLP Germany: +49 (7248) 927 19-55
- GLP N. America: +1 818 767-8899
- GLP UK: +44 1392 690140
- GLP Asia: +852 (3151) 7730
- GLP Nordic: +46 737 57 11 40

12. Technical Specifications

Strobe panel LEDs

LED Type: OSRAM LRTB GVTG
LED Count: 1320
LED Colors: RGB
LED Segments: 12 (2 x 6)

Strobe tube LEDs

LED Type: CREE XP L LED
LED Count: 216
LED Colors: Cool white
LED Segments: 12

Movement

Resolution: 8 - 16 bit
Position feedback: Yes
Tilt: 185 °

Connectors

Signal connection: XLR 5-pin input and output
Power input: Neutrik powerCON TRUE1

Operating conditions

Mains voltage: 100-240 VAC / 50-60 Hz
Power (@ 230V): 1200 W
Fuse: 6.3 x 32 mm T15A
Maximum ambient temperature: 45° C / 113° F
Operating position: Any

Shipping options

Single fixture: Cardboard (Product code 7675)
Tourpacks: 4-way and 8-way incl. flightcase

Dimensions and weight

Length: 154 mm (6.1 in)
Width: 390 mm (15.3 in)
Height (head horizontal): 284 mm (11.2 in)
Weight: 10.8 kg (24 lbs.)
Weight incl. bracket: 12 kg (26.5 lbs.)

13. Dimensions

