

# Operation Manual

## FP+ Series: Dedicated Touring Amplifiers



<b>1</b>	<b>CONTENTS .....</b>	<b>2</b>
<b>2</b>	<b>APPROVALS.....</b>	<b>4</b>
<b>3</b>	<b>WARNINGS.....</b>	<b>4</b>
3.1	Explanation of graphical symbols .....	4
3.1.1	WARNING .....	4
3.1.2	CAUTION.....	4
3.2	Important Safety Instructions .....	4
3.3	User responsibility .....	5
3.3.1	Mains connection grounding .....	5
3.3.2	Speaker output hazard.....	5
3.3.3	Radio interference .....	5
3.3.4	Speaker damage.....	5
3.3.5	Maintenance.....	5
<b>4</b>	<b>WELCOME.....</b>	<b>6</b>
4.1	Introduction.....	6
4.2	Main Features.....	6
4.2.1	Patented Class TD <sup>®</sup> amplifier and Regulated Switch Mode Power Supply (R.SMPS <sup>™</sup> ) .....	6
4.2.2	Amplifier gain .....	6
4.2.3	Voltage Peak Limiter (VPL <sup>™</sup> ) .....	6
4.2.4	Protection and performance optimization.....	6
4.2.5	NomadLink <sup>®</sup> / Ethernet control and monitoring network.....	7
<b>5</b>	<b>INSTALLATION .....</b>	<b>8</b>
5.1	Unpacking.....	8
5.2	Mounting .....	8
5.2.1	Rear support bracket .....	8
5.3	Cooling.....	9
5.4	Operating voltage .....	9
5.5	Grounding .....	9
<b>6</b>	<b>QUICK GUIDE OVERVIEW.....</b>	<b>10</b>
6.1	Front Panel overview .....	10
6.1.1	Power on/off and remote switch .....	10
6.1.2	Front Panel LED's .....	10
6.2	Rear Panel overview .....	11
6.2.1	Network and configuration section .....	12
6.2.2	The DIP-switch features.....	12
6.2.3	Input and Output connectors.....	13
6.3	Nomadlink / Ethernet network setup.....	14
<b>7</b>	<b>OPERATION AND PERFORMANCE .....</b>	<b>15</b>
7.1	Introduction.....	15
7.2	Operation precautions .....	15
7.3	Signal flow and headroom .....	15
7.3.1	Signal flow blocks.....	15

7.3.2	Headroom, sensitivity and VPL / Gain settings .....	16
7.4	Audio Input and Output connections .....	17
7.4.1	Balanced Input connections .....	17
7.4.2	Unbalanced Input connection .....	17
7.4.3	Speakon Output connections .....	17
7.4.4	Binding Post ( BP ) Output connectors .....	18
7.4.5	Output bridge mode .....	19
7.4.6	Amplifier Gain .....	19
7.4.6.1	Channel gain / Level ( Front-panel pots ) .....	19
7.4.6.2	Amplifier sensitivity .....	19
7.4.7	Output Voltage Peak Limiter, (VPL) .....	20
7.4.8	Output Current Peak Limiter (CPL) .....	20
7.5	Protection, faults and warnings .....	21
7.5.1	Introduction .....	21
7.5.2	Safe Operating Area Detector (SOAD) .....	21
7.5.3	Very High Frequency (VHF) protection .....	21
7.5.4	DC protection .....	21
7.5.5	High-impedance warning (open load) .....	22
7.5.6	Low-impedance protection (short circuit) .....	22
7.5.7	Temperature protection .....	22
7.5.8	Power Average Limiter (PAL) .....	22
7.5.9	Soft-Start .....	22
7.6	Front Panel monitoring and adjustments .....	23
7.6.1	Level indicators .....	23
7.6.2	Level adjust .....	23
7.6.3	Mute indication .....	23
7.6.4	Performance, Warning and Fault indicators .....	24
7.7	NomadLink network and DeviceControl software .....	24
7.7.1	NomadLink network in the amplifiers .....	24
7.7.2	Connection and setup .....	25
7.7.3	NomadLink network cable lengths .....	25
7.7.4	Ethernet network cable lengths .....	26
7.7.5	DeviceControl software .....	26
<b>8</b>	<b>APPENDIX .....</b>	<b>27</b>
8.1	Maintenance .....	27
8.2	FAQ .....	27
8.3	Additional documentation .....	27
8.4	Current Draw and Thermal Dissipation specifications .....	28
<b>9</b>	<b>TECHNICAL SPECIFICATIONS .....</b>	<b>35</b>
<b>10</b>	<b>WARRANTY .....</b>	<b>36</b>



This equipment conforms to the requirements of the EMC Directive 2004/108/EC and the requirements of the Low Voltage Directive 2006/95/EC.

Standards applied: EMC Emission EN55103-1, E3  
EMC Immunity EN55103-2, E3, with S/N below 1% at normal operation level.  
Electrical Safety EN60065, Class I



This equipment is tested and approved according to the U.S. safety standard ANSI/UL 60065 and Canadian safety standard CSA C22.2 NO. 60065. ETL made the tests and they are a Nationally Recognized Testing Laboratory (NRTL).

## 3 WARNINGS

### 3.1 Explanation of graphical symbols



The lightning symbol within a triangle is intended to alert the user to the presence of un-insulated "dangerous voltages" within the unit's chassis that may be of sufficient magnitude to constitute a risk of electric shock to humans.



The exclamation point within a triangle is intended to alert the user to presence of important operating and service instructions in the literature accompanying the product.

#### 3.1.1 WARNING



To reduce risk of fire or electric shock, do not expose this apparatus to rain or moisture.

Do not expose this system/apparatus to dripping or splashing and ensure that no objects filled with liquids, such as vases, are placed on the apparatus.  
L'appareil ne doit pas être exposé à des égouttements d'eau ou des éclaboussures et de plus qu'aucun objet rempli de liquide tel que des vases ne doit pas être placé sur l'appareil.

This apparatus must be connected to a mains socket outlet with a protective earthing connection.  
Cet appareil doit être raccordé à une prise de courant qui est branchée à la terre.

The mains plug is used as a disconnect device and shall remain readily operable.  
Lorsque la prise du réseau d'alimentation est utilisés comme dispositif de déconnexion, ce dispositif doit demeuré aisément accessible.

#### 3.1.2 CAUTION



To reduce the risk of fire or electric shock, do not remove screws. No user-serviceable parts inside. Refer servicing to qualified service personnel

### 3.2 Important Safety Instructions

Before using your FP+ Series product, be sure to carefully read the applicable items of this Operation Manual and the Safety Instructions.



1. Keep this manual for future reference.
2. Heed all warnings.
3. Follow all instructions.
4. Do not use this unit near water.
5. Do not spill water or other liquids into or on the unit. Do not operate the unit while wet or standing in liquid.
6. Clean only with dry cloth.
7. Do not block the air intake or exhaust ports. Install the unit in accordance with the instructions.
8. Do not operate the unit near heat producing devices such as radiators, heat registers, stoves or other apparatus that produce heat. Always operate the unit with the chassis ground wire connected to the electrical safety earth. Do not defeat the safety purpose of a grounding-type plug. A grounding-type plug has two pins and a third grounding prong. The third prong is provided for your safety. If the provided plug does not fit into your outlet, consult an electrician for replacement of the obsolete outlet.
9. Connect only to AC power outlets rated 100-120 V or 200-240 V, 50-60 Hz as dictated by the unit's voltage configuration.
10. Do not use this unit if the power cord is broken or frayed. Protect the power cord from being walked upon or pinched, particularly at the plug and the point where it exits from the apparatus.
11. Only use accessories specified by the manufacturer.
12. The unit is intended to use in a 19" rack. Follow the mounting instructions. When a rack on wheels is used, use caution when moving the loaded rack to avoid injury from tipping over.
13. Unplug this apparatus during lightning storms or when unused for long periods of time.
14. Do not connect the unit's outputs in parallel or series with any other unit's output. Do not connect the unit's output to any other voltage source, such as battery, mains source, or power supply, regardless of whether the unit is turned on or off.
15. Do not run any of the unit's outputs back into another channel's input.
16. Refer all servicing to qualified service personnel. Servicing is required when the apparatus has been damaged in any way such as:
  - ▶ Power-supply cord or plug is damaged.
  - ▶ Liquid has been spilled into the unit
  - ▶ An object has fallen into the unit
  - ▶ The unit has been exposed to rain or moisture
  - ▶ The unit does not operate normally
  - ▶ The unit was dropped or the chassis is damaged
17. Do not remove top or bottom covers. Removal of the covers will expose hazardous voltages. There are no user serviceable parts inside and removal may void the warranty.
18. An experienced user shall always supervise this professional audio equipment, especially if inexperienced adults or minors are using the equipment.
19. The mains plug is used as the disconnect device and shall remain readily accessible. If the mains plug is not readily accessible due to mounting in a 19" rack, then the mains plug for the entire rack must be readily accessible.
20. The US National Differencescl.16.3 requires that network cables must be flame rated VW-1.

---

## 3.3 User responsibility

---

### 3.3.1 Mains connection grounding



Your amplifier must be connected to a grounded socket outlet.

### 3.3.2 Speaker output hazard



Power amplifiers are capable of producing hazardous output voltages. To avoid electrical shock, do not touch any exposed speaker wiring while the amplifier is operating. The external wiring connected to the speaker terminals shall be installed by a qualified instructed person or ready-made leads or cords of appropriate capacity shall be used.



As the amplifier outputs produce high voltage, do not connect or disconnect speaker cables when the mains power is on. Also, attach the safety cover on the speaker terminals for safe operation and to comply with electrical product approvals.

### 3.3.3 Radio interference

A sample of this product has been tested and complies with the limits for the European Electro Magnetic Compatibility (EMC) directive. This equipment has also been tested and found to comply with the limits for a Class B digital device, pursuant to Part 15 of the FCC Rules. These limits are designed to provide reasonable protection against harmful interference from electrical equipment. This product uses radio frequency energy and if not used or installed in accordance with these operating instructions, may cause interference to other equipment, such as radio receivers. However, there is no guarantee that interference will not occur in a particular installation.

If this equipment does cause harmful interference to radio or television reception, which can be determined by turning the equipment on and off, the user is encouraged to try to correct the interference by one or more of the following measures:

- ▶ Reorient or relocate the antenna.
- ▶ Increase the separation between the equipment and receiver.
- ▶ Connect the equipment to an outlet on a circuit different from that to which the receiver is connected.

- ▶ Check if the affected unit complies with the EMC limits for immunity, (CE-labeled). If not, address the problem with the manufacturer or supplier. All electrical products sold in the EC must be approved for immunity against electromagnetic fields, high voltage flashes, and radio interference.
- ▶ Consult the dealer or an experienced Radio/TV technician for help.

### 3.3.4 Speaker damage



Your amplifier is very powerful and can be potentially dangerous to both loudspeakers and humans alike. Many loudspeakers can be easily damaged or destroyed by overpowering them. Always check the speaker's continuous and peak power capabilities. Although the amplifier's attenuators can be used to reduce the overall gain, an increase of the input signal can result in full output power, which may cause damage to connected speakers.

### 3.3.5 Maintenance

For safe and reliable operation, the dust covers behind the front panel should be cleaned regularly. If the dust filters are not maintained there will be safety risks. For example the unit can ignite the dust and a fire will occur due to high internal temperatures. There is also a risk that the unit will malfunction since it is dependent on constant airflow from front to rear. If the dust filters are not clean and the unit malfunctions, any resultant problems will not be covered by the warranty.

---

## 4.1 Introduction

---

Thank you for choosing Lab.gruppen FP+ Series power amplifiers for your sound reinforcement system. We are confident that you will be pleased with the performance, configuration flexibility, reliability, and long-term durability offered by the FP+ Series products.

This manual provides a comprehensive guide to the features and functionality of FP+ Series amplifiers. Please read through it to become fully acquainted with the many configuration options and multiple layers of protection circuitry. To facilitate timely installation and use of this FP+ Series product, we have included a Quick Guide Overview (section 6). This brief summary, in conjunction with Installation (section 5), contains the basic information needed to safely install the amplifier and place it in service. However, we highly recommend reading through this manual in its entirety, beginning with Main Features and Technologies and continuing through Operation and Performance. As you become thoroughly familiar with all aspects of operation, you may learn of features or options that will affect your choices on amplifier modes or loudspeaker system configuration.

The Lab.gruppen FP+ Series builds on the foundation of the road-tested fP Series, with the same sonic signature – powerful, tight bass and transparent high frequency response. In addition, the FP+ Series amplifiers establish new benchmarks for extremely high power and channel density, and also offer the benefits of remote computer monitoring and control via the NomadLink network.

---

## 4.2 Main Features

---

The FP+ Series incorporates a number of sophisticated technologies – many of them proprietary to Lab.gruppen – to ensure the best possible performance and many years of reliable operation. Familiarizing yourself with these technologies will prove invaluable in setting up and optimizing your loudspeaker system.

### 4.2.1 Patented Class TD amplifier and Regulated Switch Mode Power Supply (R.SMPS)

Lab.gruppen's patented Class TD technology combines the exceptional efficiency of a Class D amplifier with the high sonic quality associated with Class B designs. Class TD also incorporates the same basic concepts behind Class H designs, but here they are refined and pushed to a higher level to achieve greater efficiency.

The Class TD output sections work in concert with Lab.gruppen's unique, Regulated Switch Mode Power Supply (R.SMPS) to create a superior overall power amplifier topology. R.SMPS ensures stable, full output power over an extremely wide range of mains voltage levels. Sagging or fluctuating mains voltage will not affect the power output delivered to the loudspeakers.

### 4.2.2 Amplifier gain

For greater flexibility in system integration, FP+ Series amplifiers allow gain adjustment from +23 dB to +44 dB in 3 dB steps. This feature accommodates any combination of input device and loudspeaker type. For example, if the input signal is weak, the gain can be boosted to maintain maximum power output while avoiding a poor signal-to-noise ratio. This gain adjustment feature makes it easier to achieve an optimal balance between headroom and noise floor.

### 4.2.3 Voltage Peak Limiter (VPL)

The Voltage Peak Limiter (VPL) feature allows user adjustments that determine maximum voltage output, thus matching the amplifier to the connected speaker load. Regardless of load impedance, the VPL feature can be set to ensure that neither temperature nor current limitations are exceeded before reaching the desired voltage threshold.

### 4.2.4 Protection and performance optimization

Appropriate and reliable power amplification is vital to any audio system. Inadequate or faulty power amplification could cause damage to the loudspeakers, or in some cases to the power amplifiers themselves. To prevent any damage or costly service interruptions, FP+ Series amplifiers offer advanced features to protect both internal circuits and any connected loads. These features even protect the mains fuse that, in extreme cases, could be overloaded.

Following are short descriptions of standard built-in FP+ Series protection features:

- ▶ **CPL**, (Current Peak Limiter) ensures that the amplifier's output does not exceed the safe current handling parameters of amplifier components.
- ▶ **Temperature protection** ensures that the amplifier will not be damaged by exceeding thermal limits.
- ▶ **PAL**, (Power Average Limiter) limits the maximum average power consumption according to the power supply and mains-breaker capabilities.
- ▶ **VHF**, (Very High Frequency) protection circuits mute the output of the amplifier when non-dynamic continuous signals above 10 kHz are detected.
- ▶ **DC protection** ensures destructive DC signals will not appear at the amplifier outputs. If such conditions occur an internal fuse opens and fault indication is displayed.
- ▶ **Low-impedance** (short circuit) protection provides a fault warning indication and shuts down the output stage when, for example, an input signal is present and a malfunctioning cable or driver is short circuiting the output.
- ▶ **High-impedance** warning reports an alert when, at the same time, output signal is high and no current draw is measured. This situation might occur when no speakers are connected, or when a driver is blown.
- ▶ **Low inrush current** ensures that the mains breaker will not trip when several power amplifiers are turned on simultaneously.

#### 4.2.5 NomadLink / Ethernet control and monitoring network

The NomadLink network allows easy setup, monitoring, and control of FP+ Series power amplifiers and other Lab.gruppen NomadLink-enabled amplifiers. The patented network topology provides automatic detection and addressing of multiple amplifiers, and is controlled from a PC via the optional NLB 60E NomadLink Bridge & Network Controller using standard TCP/IP communication. Phantom powering through the network cables enables the software to detect devices that are not currently turned on or connected to the mains. This ensures very high reliability and redundancy levels while allowing connected amplifiers to remain on standby with no power consumption.

Cable connections can be daisy-chained for easier system setup. This also reduces total component costs, simplifies installation, and makes daily operation more convenient. There is no need to create a star topology using many switches as with, for example, an Ethernet system. Individual amplifier addresses do not need to be manually entered; you will automatically know where an individual amplifier resides in the network.

A daisy chain network loop, in combination with the automatic addressing of devices, enables Lab.gruppen's proprietary DeviceControl software to automatically create a precise picture of all connected devices and their relative position in the chain. By quickly creating a clear overview of the entire system configuration, DeviceControl provides flexible control of very large amplifier systems. Set-up time is minimized, and critical information is readily available for monitoring performance and solving problems during operation.

Via NomadLink, you can monitor all metering data as well as all faults and warning indications simultaneously. NomadLink also allows you to remotely control power on and power off, as well as engage Mute and Solo functions on individual channels.

---

## 5.1 Unpacking

---

Carefully open the shipping carton and check for any noticeable damage. Every Lab.gruppen amplifier is tested and inspected before leaving the factory and should arrive in perfect condition. If any damage is discovered, please notify the shipping company immediately. Only the consignee may institute a claim with the carrier for damage incurred during shipping. Save the carton and packing materials for the carrier's inspection. Should you ever need to ship the amplifier, always use the original packaging materials.

---

## 5.2 Mounting

---

Free airflow from front-to-rear of the amplifier must be possible. Therefore, no doors or rack-lids should be mounted in front of or behind the amplifiers.

Amplifiers may be stacked directly on top of each other. There is no need for spacing in between units, though this might enable more convenient installation of cabling on the rear panel.

It is recommended that rear supports be mounted for maximum long-term stability. Rear support brackets are included.

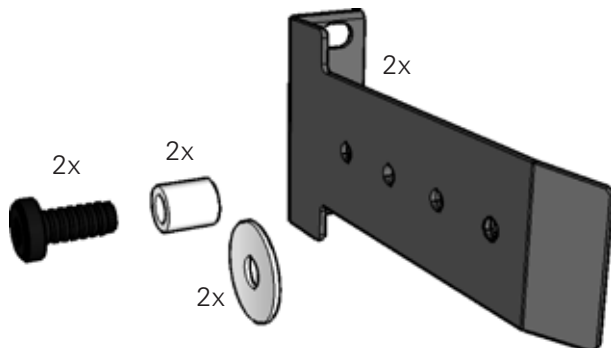

**Figure 5.2a: Rear support mounting hardware**

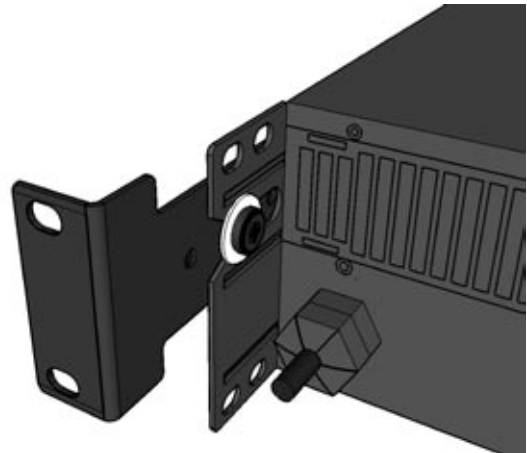

**Figure 5.2b: Use washer for fixed installation**

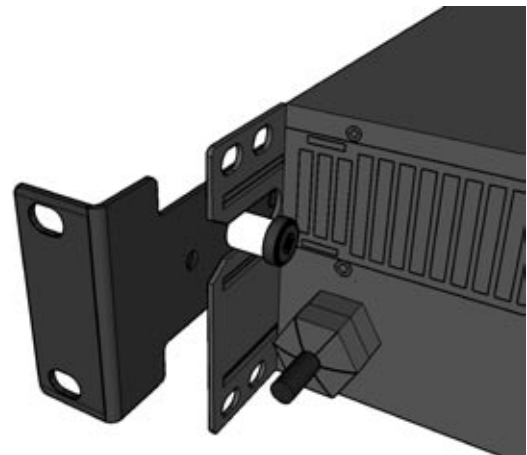

**Figure 5.2c: Use tube for slide-on installation.**



### 5.3 Cooling

The amplifier uses a forced-air cooling system with air flow from front to rear, maintaining a low operating temperature within defined limits. Front-to-rear air flow is preferred as cooler air is present at the front in nearly all applications. (This allows higher continuous power levels without encountering thermal problems.) Never attempt to reverse the airflow. The amplifier modules require a pressure chamber between the fans and heatsink, and this effect functions only in one direction.

Make sure that there is an adequate air supply in front of the amplifier, and that the rear of the amplifier has sufficient space to allow the exhaust to escape. If the amplifier is rack-mounted, do not use covers or doors on the front or rear of the rack.

Should a heat sink overheat, the temperature sensing circuits will mute the overheating channel. If the power supply overheats, another sensing circuit will mute all output channels until the power supply cools to safe operating temperature. An early warning before shut down will be indicated on the front panel LEDs, and a warning will be sent through the NomadLink network.

Always make sure that the dust-filters behind the detachable front panel are clean to ensure maximum possible airflow.



If the amplifier malfunctions due to dirty dust filters, any required repairs are not covered by the warranty.

### 5.4 Operating voltage

 The label placed to the right of the mains cable on the rear of the amplifier indicates the AC mains voltage for which the amplifier is wired and approved: 115 V or 230 V. Connect the power cable only to the AC source type referred to on the label. The warranty will not cover damage caused by connecting to an incorrect type of AC mains.

Lab.gruppen switch mode amplifiers use primary switching. Because the mains power is rectified

directly in front of the transformer, the amplifier is insensitive to mains frequency. It may be connected to 50 or 60 Hz sources, and actually will operate on line frequencies from DC to 400 Hz.

If the power plug mounted at the factory is not appropriate for your country, it can be removed and the proper connector wired in its place as follows:

BLACK or BROWN	LIVE
WHITE or BLUE	NEUTRAL
GREEN or GREEN/YELLOW	EARTH(GROUND)

 If you are not 100% confident of your competence to replace the mains plug, engage qualified personnel to do the job.

Once a suitable AC supply is connected, the amplifier can be turned on using the front panel power switch. The amplifier then goes through a soft-start sequence as it self-checks its circuits. The fans will blow at high speed before dropping to idle, and the “power” LED will illuminate.

Inrush power is controlled and limited during “soft-start”, enabling multiple amplifiers to be powered up simultaneously.

### 5.5 Grounding

There is no ground lift switch or terminal on the FP+ Series amplifiers. The signal ground is always floating, via a resistor, to chassis and therefore the grounding system is automatic.

In the interests of safety, never disconnect the earth (ground) pin on the AC power cord.

Use balanced input connections to avoid hum and interference.

### 6.1 Front-Panel overview

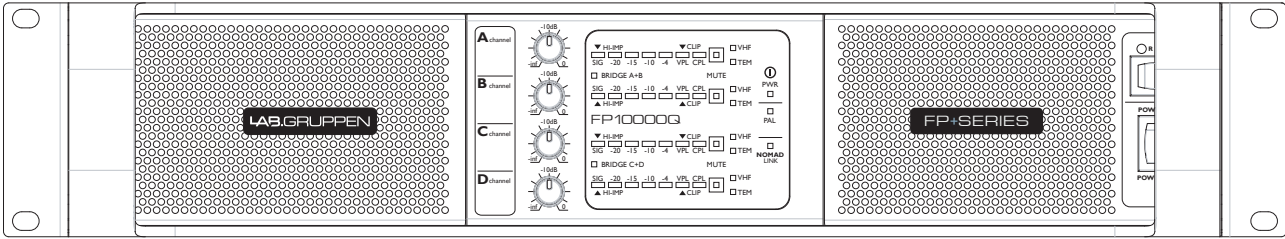

The amplifier’s front panel presents the performance and fault condition indicators, power and remote switches, and a removable dust-filter cover. Level potentiometers provide individual attenuation for the amplifier channels. Range is 0 dB to - infinity. (The 12 o’clock position indicates -10 dB attenuation.) A convenient label strip with writing surface is provided adjacent to each level potentiometer.

To remove the dust-filter covers, loosen the thumbscrews located underneath the front handles. This allows removal of the dust-filters for cleaning. The covers may be made “tamper resistant” by replacing the thumbscrews with Philips head or safety Torx screw. Thread size is M3.



The amplifier never should be operated without the dust-filters in place.

#### 6.1.1 Power on/off and remote switch

The Power on/off switch is located on the right side. A second switch, labeled “REMOTE,” is above the Power switch. When the Remote switch is on (with mains connected and power on/off switch on), the yellow LED above it will illuminate indicating that external power on/off commands from the NomadLink network connection will switch the amplifier on or off. When Remote is activated the amplifier will not switch on until a “Power On” command is received from the network. When the remote switch is off, it is not possible to switch amplifier power on or off using NomadLink network control.

#### 6.1.2 Front-panel LED’s

The front-panel LED area includes the following indicators per channel:

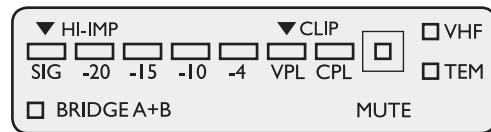
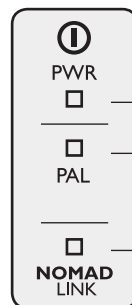

Figure 6.1.2a: Front panel LED field (per-channel)

- ▶ **VHF** - Very High Frequency protection active (output muted) (Yellow constant)
- ▶ **TEM** - Temperature warning (Yellow flashing)
- ▶ **TEM** - Temperature mute (Yellow constant)
- ▶ **MUTE** - Channel muted via NomadLink network or due to a fault condition (Red)
- ▶ **CPL** - Current Peak Limiter (CPL) active (Orange flashing)
- ▶ **CPL** - (Orange constant with output muted): Low impedance / short circuit detection fault
- ▶ **VPL** - Voltage Peak Limiter (VPL) active
- ▶ **SIG** - Signal levels - 40 dB (Sig) to -4 dB
- ▶ **Hi-Imp** - High-impedance/open load detected (Orange)
- ▶ **Bridge** - Bridge mode operation (Yellow)



When no VPL, CPL or PAL indicators are illuminated, and the VPL DIP-switch is set to maximum at the specified nominal load, the amplifier channel is able to deliver maximum rated output power



- (PWR) Power on (Green)
- (PAL) Power Average Limiter active (Red)
- NomadLink network active (Blue)

Figure 6.1.2b: Front panel global LED field



When the network is connected, the blue NomadLink LED will illuminate even when mains power is not connected. NomadLink receives phantom power from the network as supplied by the NLB 60E.

## 6.2 Rear-Panel overview

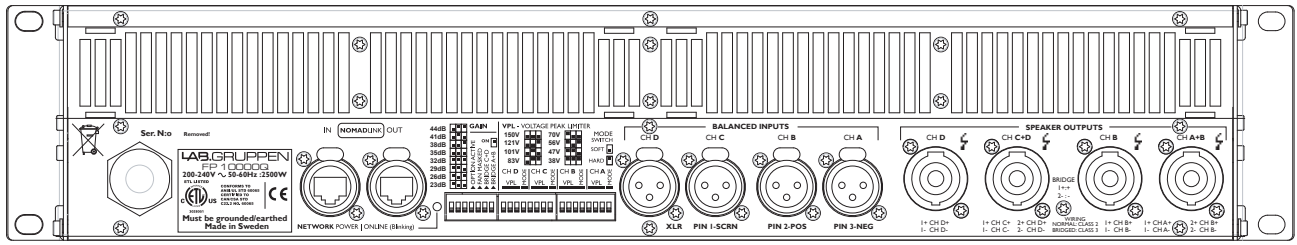

Mains input 115 V or 230 V operation (Not selectable)

NomadLink network In and Out on EtherCon™-housed RJ45 connections

DIP-switches for adjusting key features (See below)

XLR connectors for inputs and loop thru

4 channel version shown with Neutrik Speakon output connectors

Figure 6.2: Two- and four-channel speaker output connector options (not applicable to all models)

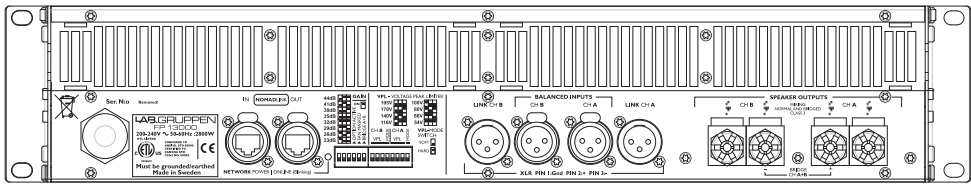

Rear view of two-channel model fitted with Binding Post connectors

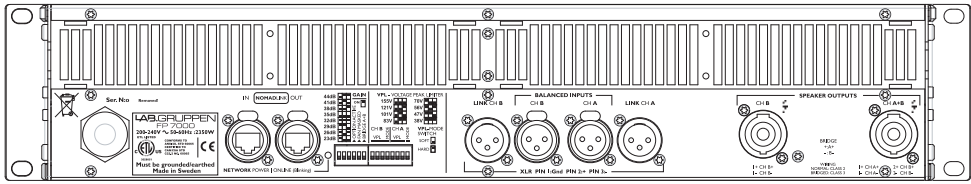

Rear view of two-channel model fitted with Speakon connectors

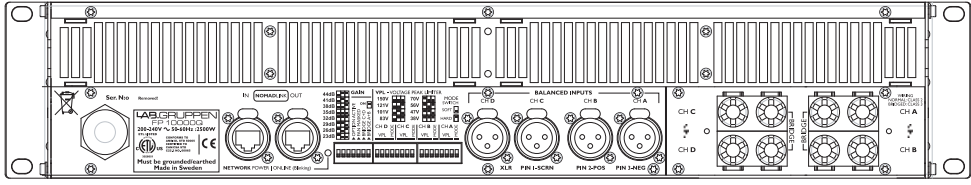

Rear view of four-channel model fitted with Binding Post connectors

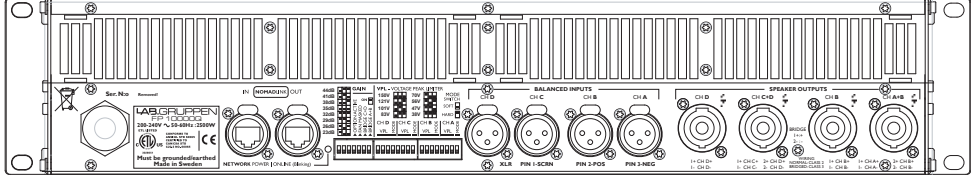

Rear view of four-channel model fitted with Speakon connectors

6.2.1 Network and Configuration section



Four-channel model shown. Two-channel versions have VPL and Bridge Mode switches for channels A and B only. All models have different VPL values. Functions are otherwise identical.

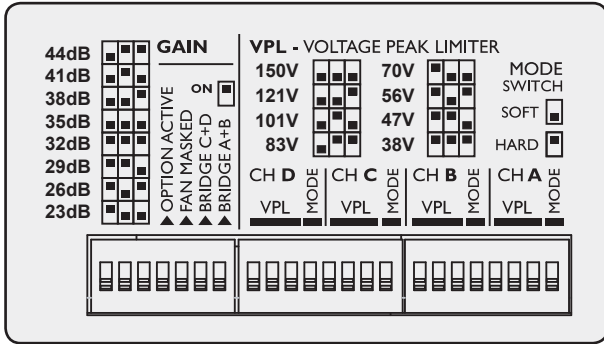

Figure 6.2.2a: Rear panel DIP-switch field

6.2.2 The DIP-switch features

The following features may be adjusted using the DIP-switches on the rear panel of the amplifier.

**Gain** - Globally set for all channels, from +23 dB to +44 dB in 3 dB steps.

**Option active** - Not currently implemented.

**Fan Masked** - When on, engages the intelligent fan feature; fan speed is lowered when no signal is present.

**Bridge A+B and C+D** - Switches the channel pairs into bridge mode operation. An automatic -6 dB gain compensation is applied.

**VPL** - The Voltage Peak Limiter provides optimum peak voltage settings for each channel. Level selections vary by model within the FP+ Series.

**Mode** - Select VPL mode to either Hard or Soft operation. For channels driving sub-woofers and low-frequency drivers, it is recommended to use the Hard setting for optimal operation. For mid- and high-frequency drivers, always select Soft.

VPL in Standard Mode						
FP 14000	FP 13000	FP 9000	FP 7000	FP 4000	FP 10000Q	FP 6000Q
195 V	195 V	170 V	155 V	121 V	150 V	101 V
170 V	170 V	140 V	121 V	101 V	121 V	83 V
140 V	140 V	116 V	101 V	83 V	101 V	70 V
116 V	116 V	100 V	83 V	70 V	83 V	56 V
100 V	100 V	80 V	70 V	56 V	70 V	47 V
80 V	80 V	66 V	56 V	47 V	56 V	38 V
66 V	66 V	54 V	47 V	38 V	47 V	n/a
54 V	54 V	n/a	38 V	n/a	38 V	n/a

Table 6.2.2b: VPL voltage selections in Standard Mode

VPL in Bridge Mode						
FP 14000	FP 13000	FP 9000	FP 7000	FP 4000	FP 10000Q	FP 6000Q
195 V	390 V	340 V	310 V	242 V	300 V	202 V
170 V	340 V	280 V	242 V	202 V	242 V	166 V
140 V	280 V	232 V	202 V	166 V	202 V	140 V
116 V	232 V	200 V	166 V	140 V	166 V	112 V
100 V	200 V	160 V	140 V	112 V	140 V	94 V
80 V	160 V	132 V	112 V	94 V	112 V	76 V
66 V	132 V	108 V	94 V	76 V	94 V	n/a
54 V	108 V	n/a	76 V	n/a	76 V	n/a

Table 6.2.2c: VPL voltage selections in Bridge Mode

### 6.2.3 Input and Output connectors

All FP+ Series amplifiers are equipped with balanced XLR-F input connectors. two-channel models also offer parallel (“loop-thru”) XLR-M output connectors for daisy-chaining multiple amplifiers from the same signal source.

All FP+ Series amplifiers except the FP 9000, FP 13000 and FP 14000 offer a choice of either binding post (BP) or Neutrik® NL4FC Speakon output connectors (SP). The FP 9000, FP 13000 and FP 14000 are offered with BP connectors only as the potential maximum output current exceeds the recommended limits for the Speakon connectors.

For specific configuration and wiring information, see section 7.4.

**Figure 6.2.3a: Two- and four-channel input connector configurations**

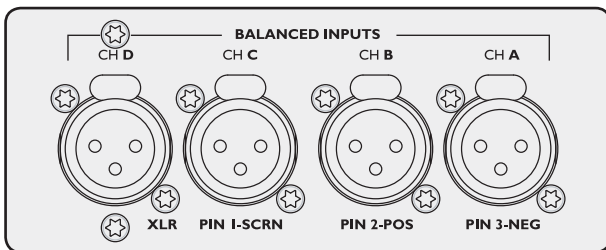

Audio inputs - four-channel models

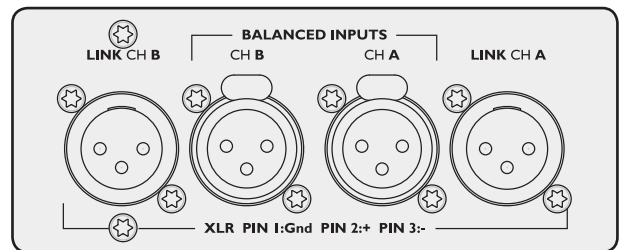

Audio inputs and loop-thru connectors - two-channel models

**Figure 6.2.3b: Two- and four-channel speaker output configurations**

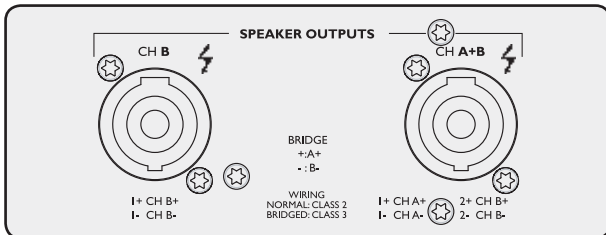

Speakon outputs - two-channel models

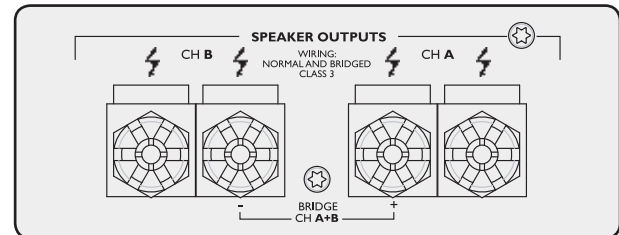

Binding Posts - two-channel models

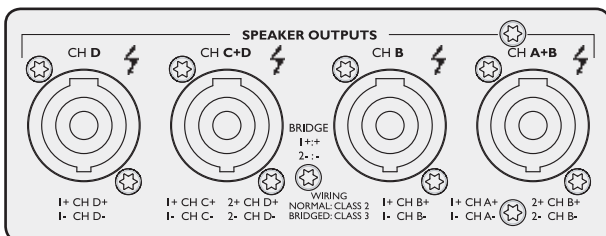

Speakon outputs - four-channel models

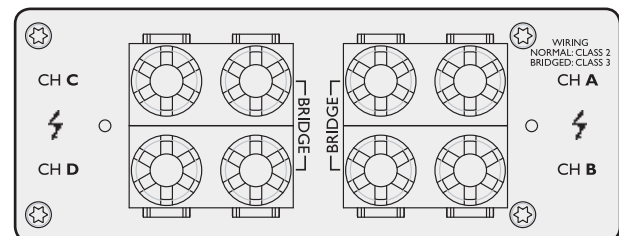

Binding Post outputs - four-channel model

### 6.3 NomadLink / Ethernet network setup

The amplifier includes, as a standard feature, internal facilities for the NomadLink monitoring and control network. All features of the NomadLink network are accessible via a PC running Lab.gruppen's proprietary DeviceControl software. A single rackspace NLB 60E NomadLink Bridge & Network Controller accepts the TCP/IP data stream from the computer and converts it to the NomadLink protocols. Even when no computer is connected, the NLB 60E can initiate stand-alone power on/off and muting functions, as well as report any fault or warning conditions.

The PC is connected to the NLB 60E using a standard Ethernet interface and a crossed Cat-5 cable (peer-to-peer setup). If a HUB or switch is in the network, standard "straight" Cat-5 cables must be used. The front and rear Ethernet connections on the NLB 60E can be used individually, but only one PC at a time running DeviceControl can access the subnet.



Many newer laptop computers will allow peer-to-peer connection with the NLB 60E using a standard "straight" Cat-5 cable instead of a crossed Cat-5 cable.

The default fixed TCP/IP address of the NLB 60E is 192.168.1.166. The subnet mask is 255.255.255.0. For further details, please refer to instructions supplied with the NLB 60E unit.

**Figure 6.3:**  
**NomadLink network wiring configuration**

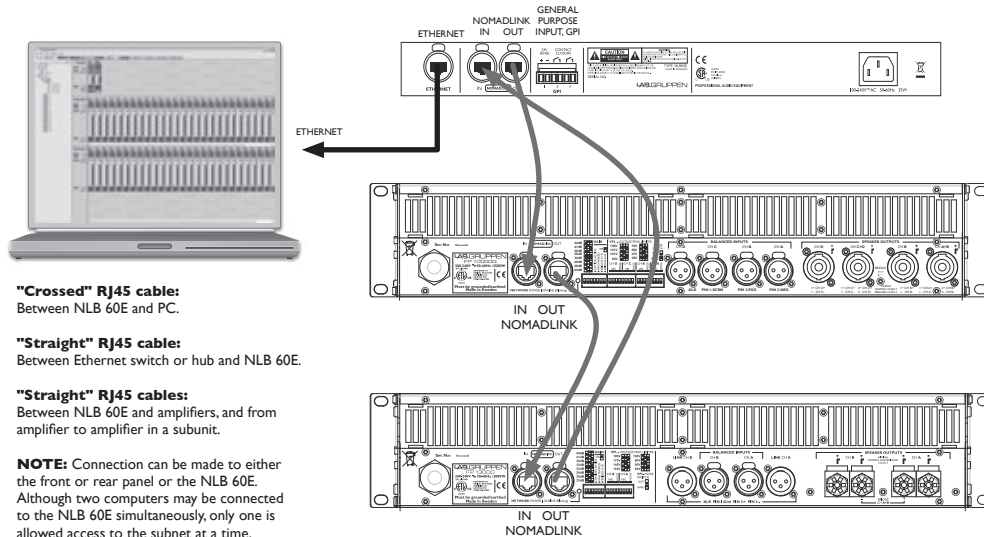

The NomadLink connections use standard "straight" Cat-5/RJ45 equipped cables. For a safer mechanical connection it is possible to use Neutrik EtherCon "XLR-type" housings on the cables.



US National Differences cl.16.3 requires that NomadLink network cables must be rated VW-1.

The OUT port from the NLB 60E must be connected to the IN port of the first amplifier. The OUT port from the first amplifier in turn connects to the next amplifier's IN port to form a daisy-chain. The OUT port on the last amplifier is connected to the IN port on the NLB 60E to close the loop.



There are electrical limitations to cable lengths on a NomadLink network, both in terms of total cable length in the loop and between any two devices. Read the

Operation and Performance chapter in this manual, or the instructions supplied with the NLB 60E, to ensure the network is configured within these parameters.



Although the network will function as an open loop under most circumstances, it is strongly recommended that the loop be closed by connecting the last amplifier's

OUT port to the NLB 60E's IN port. Doing so will improve redundancy and communication speed.

External contact closures and 24 V low/high triggers can be connected to the GPI connectors on the NLB 60E for control of fire-alarm systems or external power sequencers. For more details read the instructions supplied with the NLB 60E.

## 7.1 Introduction

The following sections provide comprehensive information on amplifier connection, setup, operation, and performance. The detailed information included here is essential to realizing the full functionality of the FP+ Series amplifiers.

## 7.2 Operation precautions

- ▶ Make sure that the Power switch and the Remote switch on the amplifier front panel are set to “off” before making any input, output or network connections, and also before manipulating the DIP-switches on the rear panel.
- ▶ Make sure that the AC mains voltage is correct and matches the voltage printed on the rear panel of the amplifier (115 V or 230 V).
- ▶ Make sure that no signal is present at the input to the amplifier when powering up. An input signal could produce an unintentionally loud initial volume from the speakers.

## 7.3 Signal flow and headroom

### 7.3.1 Signal flow blocks

All FP+ Series amplifiers have the same signal flow, and the same feature sets. The only internal differences are in the maximum output current per channel and VPL settings.

The input stage of all FP+ Series amplifiers has a high sensitivity to provide ample system headroom. This in effect means that the input stage is almost impossible to clip.

Overall amplifier input gain is adjusted using the input stage DIP-switches. Please note that the gain setting is global, affecting all channels. Following the input stage, the dedicated level control on each channel allows signal attenuation from 0 dB to minus infinity.

The Current Peak Limiter (CPL) section dynamically limits the input signal based on three parameters: sensed current level, feedback from the output stage, and sensed voltage clip from the VPL (and output amplifier voltage clip if “Soft Clip” is activated). This ensures that power output is maintained within the design limits of the amplifier.

The adjustable Voltage Peak Limiter (VPL) sets the maximum output voltage and therefore also the maximum output power. Eight different voltage stages are available using the DIP-switches on the rear panel of all models, except the FP 9000 and FP 4000 that both have seven stages and the FP 6000Q which provides six voltage stages.

The sophisticated output section monitors faults and generates appropriate warnings, which are displayed on the amplifier front panel and transmitted through the NomadLink network. These alerts allow the operator to adjust system settings and thereby avoid problems. In the rare event that conditions are extraordinarily severe, the amplifier will shut down until the fault or problem setting has been rectified or adjusted. These sensing circuits are also employed to feed back voltage and current level information, via a side chain, to the limiters. Sensing circuits also transmit local amplifier module temperature and power supply temperature to the appropriate protection mechanisms. Read the Protection, Faults and Warnings section for further details.

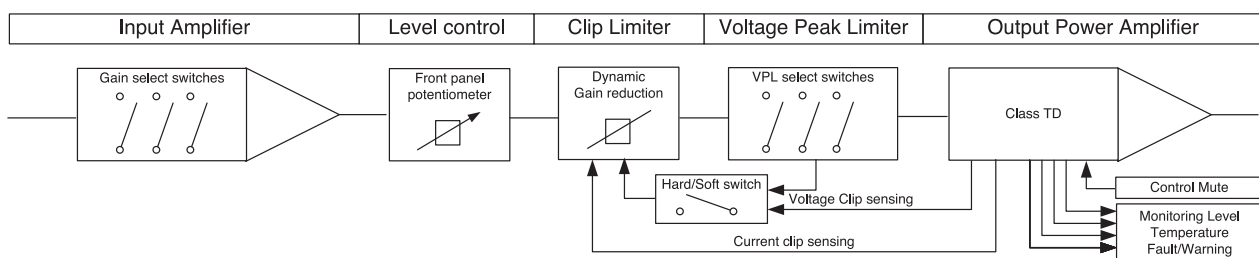

**Figure 7.3.1: FP+ Series signal flow diagram**

**7.3.2 Headroom, sensitivity and VPL / Gain settings**

The input amplifier and limiter system is designed to accommodate extremes of performance. Typically, exceeding maximum input by much as +10 dB will only result in a 1% increase in distortion. The following schematics illustrate how the adjustable VPL and Gain circuitry affect input sensitivity and output power.

The tables to the left of the illustration 7.3.2 below show input sensitivity for a FP 13000 with a 2 ohm load and 195 V peak (max.) and 54 V peak (min.) respectively for the eight different gain stages between +23 dB and +44 dB. The resulting output power is displayed in dBu, Vrms and watts in the tables to the far right. Complete input sensitivity tables for all VPL and Gain settings for all FP+ Series models can be found at [www.labgruppen.com](http://www.labgruppen.com).

The headroom available through the input stage to the clip limiter is shown by the dotted lines as +10 dB at 195 V peak and +16.1 dB at 54 V peak. These lines illustrate the additional signal level that can be accepted at the input before any significant distortion will appear at the input stage.



If you use the level potentiometer in the signal chain to reduce the level by an amount greater than the headroom relative to input sensitivity, AND you drive the amplifier to clip level, you are in danger of clipping the input stage before the current or voltage peak limiters are activated.



When bridging two channels, you must add +6 dB to the input sensitivity to achieve maximum output voltage due to the automatic -6 dB gain compensation inserted by the amplifier.

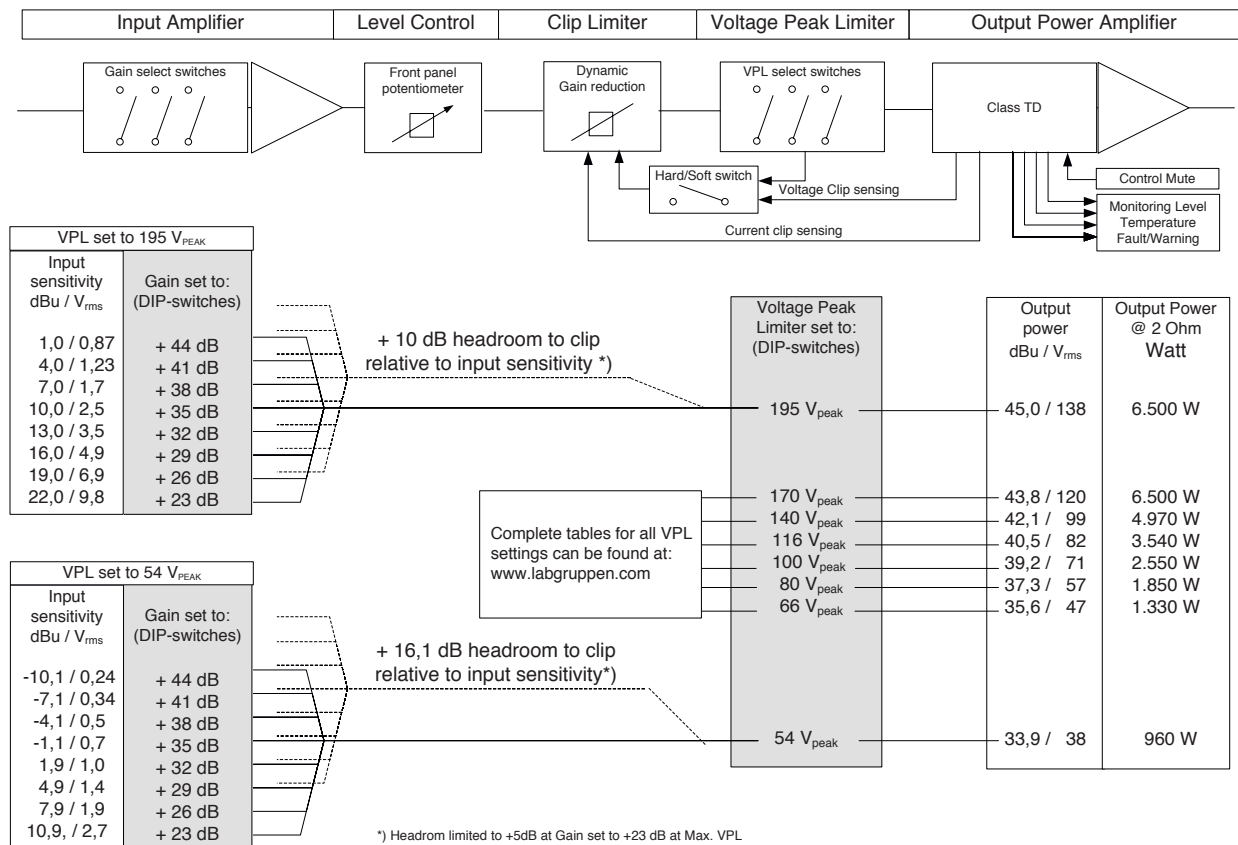

Figure 7.3.2: FP 13000 VPL and GAIN settings



## 7.4 Audio Input and Output connections

### 7.4.1 Balanced Input connections

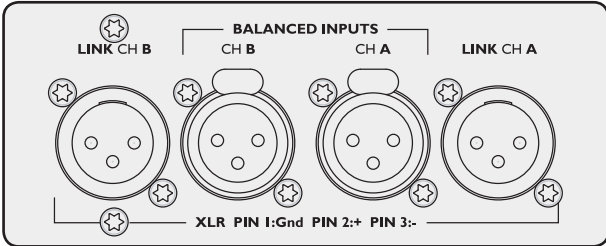

Figure 7.4.1a: Audio inputs and loop-thru connectors - two-channel models

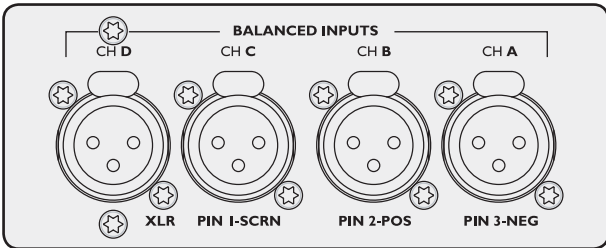

Figure 7.4.1a: Audio inputs - four-channel models

The XLR input connectors are electronically balanced, and wired according to the IEC 268 standard (pin 2 = hot). XLR input connectors should be wired as follows:

- Pin 1 Ground/shield
- Pin 2 Hot (+)
- Pin 3 Cold (-)

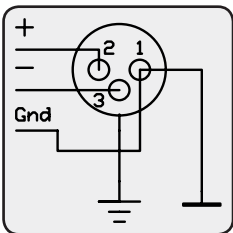

Figure 7.4.1c: Balanced XLR wiring schematic



When linking the same source signal to several input channels, be aware that there is a limit to the number of channels an output source can “drive”. A typical output source (e.g. a DSP crossover unit) can drive up to four amplifier channels before external line-drivers might be required to buffer the signal.

### 7.4.2 Unbalanced Input connections

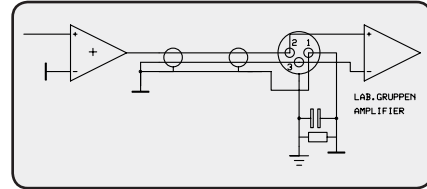

Figure 7.4.2: Unbalanced XLR wiring schematic

To connect an input to an unbalanced source, it is possible to connect pins 1 and 3 in the XLR plug at the amplifier end of the cable. However, a better method is to connect pin 3 to the shield at the source end of the cable, as this usually results in better hum and noise rejection. Balanced input connections are recommended whenever possible.

### 7.4.3 Speakon Output connections

Refer to the instructions in this section if your amplifier is equipped with the Speakon output connectors.

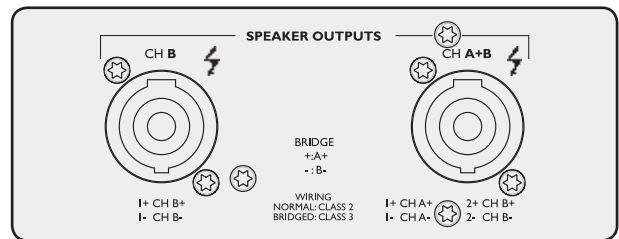

Figure 7.4.3a: Speakon outputs - two-channel models

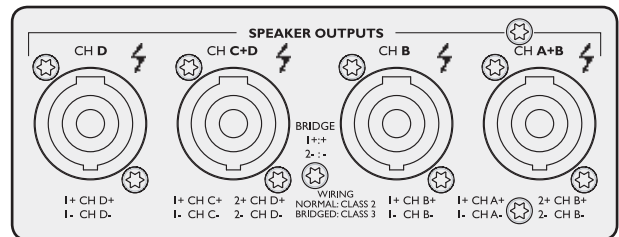
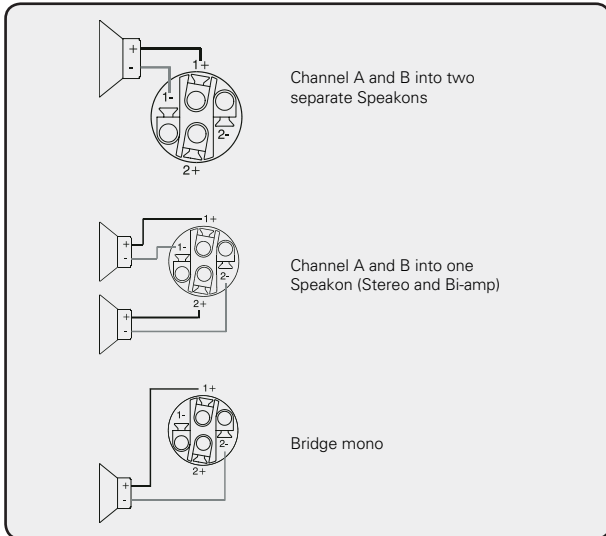

Figure 7.4.3b: Speakon outputs - four-channel models

**Two-channel amplifiers** – Two-channel amplifiers are wired in the following manner. The right Speakon connector, Channel A+B, provides outputs for both Channel A and Channel B. This output is useful when wiring the amplifier for bridged mono operation. See section 7.4.6. The left Speakon connector provides an output for Channel B only.

Connect the + and – loudspeaker cables as shown in the illustrations below.

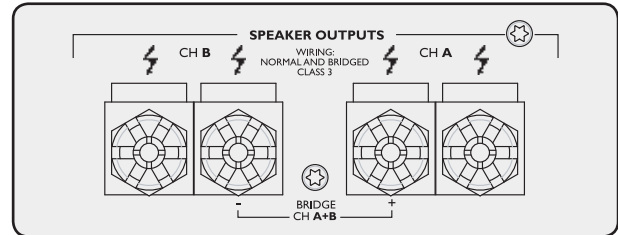

**Figure 7.4.3c: Speakon wiring schematic**

**Four-channel amplifiers** – Additional connectors are provided for Channel C and Channel D. Channel C functions as Channel A above, and Channel D as Channel B above.

## 7.4.4 Binding Post (BP) Output connectors

Refer to the instructions in this section if your amplifier is equipped with Binding Post output connectors.



**Figure 7.4.4a: Binding Post outputs - two-channel models**

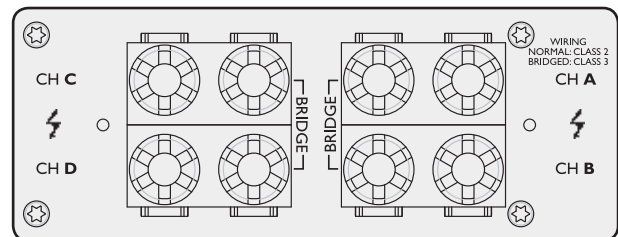

**Figure 7.4.4b: Binding Post outputs - four-channel models**

Connect the positive (+) loudspeaker cable to the positive (+) red terminals. Connect the negative (-) loudspeaker cable to the negative (-) black terminals. For bridge mode, connect the positive (+) terminal on Channel A to the positive (+) loudspeaker cable and the negative (-) terminal on Channel B to the negative (-) loudspeaker cable.

Channels C and D on four-channel versions are connected in the same manner. For bridge mode, connect the positive (+) terminal on Channel C to the positive (+) loudspeaker cable and the negative (-) terminal on Channel D to the negative (-) loudspeaker cable.

**⚠** The outputs on all FP+ Series amplifiers produce high voltage. Do not connect or disconnect the loudspeaker cables while the mains power is on. Never operate the amplifier with any portion of bare loudspeaker wire exposed. Also, attach the safety cover (4-channel Speakon versions only) on the speaker terminals for safe operation and to comply with electrical product approvals.



Never connect an output terminal to ground, or to any other input or output. Observe relative loudspeaker polarity: loudspeakers connected in reverse polarity will exhibit degraded performance, particularly in bass frequencies, and may be damaged as a consequence.



Use a high-quality stranded loudspeaker cable, and keep cable runs as short as possible.

### 7.4.5 Output bridge mode

It is possible to bridge channels in two-channel versions, or in pairs of two (A+B and C+D) in four-channel versions. When bridged, the input source must be connected to input A (A+B) or C (C+D) respectively. Output speaker cables must be connected to the plus pole on channel A or C and the minus pole on B or D.

The main benefit of bridging the output is a doubling of output voltage. Bridging can be used to turn a four-channel FP 10000Q amplifier, for example into a three-channel amplifier with 2 x 1300 W and 1 x 4200 W at 8 ohms or 2 x 2100 W and 1 x 5000 W at 4 ohms

Most power amplifier designs, when bridged, automatically introduce a +6 dB input gain boost which can lead the user to conclude that said amplifier delivers “more than double the power” when in bridge mode. This is clearly not the case, as the gain boost artificially enhances perceived power at the cost of headroom. The FP+ Series amplifiers work on globally set constant gain, and automatically compensate the input gain by -6 dB. For example, if the amplifier is configured in a three-channel mode, then the selected gain is maintained from input to output on all channels.

### 7.4.6 Amplifier Gain

All FP+ Series amplifiers feature adjustable input gain. This versatility enables the amplifier to accommodate a multitude of system configurations with various input sources and speaker layouts. Amplifier gain is set globally for all channels. The range is +23 dB to +44 dB in 3 dB steps. Individual channel fine level adjustment is available using the potentiometers on the front panel.

The unique adjustable input gain feature of the FP+ Series makes it easier to attain the optimum balance between headroom and signal-to-noise ratio in the signal path. A weak signal at the input might require the gain to be raised in order to achieve maximum output power with the lowest signal-to-noise ratio. A “hot” input signal, however, would require a lowering of the gain to avoid sending the amplifier into Voltage or Current clipping. See Appendix to review the table containing Gain versus VPL setting implications for input sensitivity and output power. Bridge mode operation automatically compensates by -6 dB, keeping all channels at the same gain.

#### 7.4.6.1 Channel gain/level (front-panel pots)

Individual channel gain (level) may be adjusted using the potentiometers located on the front panel. Range is from 0 dB to -infinity in 31 steps. The attenuation is logarithmic, with the 12 o'clock position indicating -10 dB.



If the level control is used to attenuate to a lower level than the headroom relative to input sensitivity AND the amplifier input is driven into clip, there is a danger of clipping the input stage before the current or voltage peak limiters are activated.

#### 7.4.6.2 Amplifier sensitivity

Sensitivity is defined as how many Volts (rms) or dBu (referred to 0.775 Vrms) are required to achieve full (maximum) output power. As the output power varies with the load impedance, 4 ohms is usually the common reference. Since FP+ Series amplifiers are capable of providing multiple maximum output power levels through use of the VPL feature, many sensitivity calculations may be required for a single amplifier. We recommend use of the DeviceControl software to simplify this process. DeviceControl's Device View page, used in combination with the DIP-switch settings display, will automatically produce a sensitivity calculation from the given data (VPL, Gain and load).

### 7.4.7 Output Voltage Peak Limiter (VPL)

Voltage Peak Limiter (VPL) is a unique feature in FP+ Series amplifiers. It is used to select the maximum power available on each output channel. VPL levels are set using the rear-panel DIP-switches; eight level positions are offered on all models except the FP 6000Q, which offers six).

FP 14000	
V peak	V rms
195	138
170	121
140	99
116	82
100	71
80	57
66	47
54	38

FP 13000	
V peak	V rms
195	138
170	121
140	99
116	82
100	71
80	57
66	47
54	38

FP 9000	
V peak	V rms
170	121
140	99
116	82
100	71
80	57
66	47
54	38

FP 7000	
V peak	V rms
155	110
121	86
101	72
83	59
70	50
56	40
47	33
38	27

FP 4000	
V peak	V rms
121	86
101	72
83	59
70	50
56	40
47	33
38	27

FP 10000Q	
V peak	V rms
150	106
121	86
101	72
83	59
70	50
56	40
47	33
38	27

FP 6000Q	
V peak	V rms
101	72
83	59
70	50
56	40
47	33
38	27

The values for VPL are displayed as maximum Voltage Peak. To translate Voltage Peak into Vrms, you must divide the Voltage Peak values by 1.41 (see table). The VPL allows you to set the correct maximum output peak power for optimum performance with the connected speakers. The correct setting depends on the system type and the specific load connected to the channel. Since each channel can be configured to deliver either very high voltage peak power OR high current draw at low-impedances, it is important to set the VPL correctly.

If you choose a lower VPL setting, you only reduce the maximum output voltage. At the same time, this allows more current headroom for low-impedance loads. The amplifier thus runs at higher efficiency, with a significantly reduced risk of going into thermal protection.

### 7.4.8 Output Current Peak Limiter (CPL)

The Current Peak Limiter (CPL) ensures that the amplifier will not be damaged by forcing the amplifier to deliver current levels to the outputs that exceed the physical limits of the transistors. The CPL keeps the amplifier within the Safe Operating Area (SOA).

The CPL is non-adjustable and has different limit values depending on model type.

CPL activity is indicated by illumination of an orange LED for each channel on the front panel. Warnings also are shown in the DeviceControl software's GUI.

A steadily illuminated orange CPL LED (with MUTE illuminated) indicates a short circuit situation (or very low-impedance). The output will mute for 6 seconds before measuring the output impedance again. This will continue until the short circuit is fixed, at which time the output will automatically un-mute. An input signal must be present to allow detection of short circuit or low-impedance conditions.



The problem can be solved by checking input and output cables and examining the state of the loudspeaker load. If there is no short circuit present, then the condition may be rectified by lowering the VPL or input levels.

**Table 7.4.7: V peak to Vrms tables for the FP+ Series**

## 7.5 Protection, faults and warnings

### 7.5.1 Introduction

The FP+ Series amplifiers incorporate a sophisticated and comprehensive set of protection features. Faults and warnings are indicated on the front panel and reported via the NomadLink network for indication on the DeviceControl GUI.

### 7.5.2 Safe Operating Area Detector (SOAD)

The Safe Operating Area Detector (SOAD) compares output voltage against output current to ensure that the output transistors are working inside their safe operating area.

The SOAD provides fault monitoring and input to the Current Peak Limiter (CPL). The SOAD has no dedicated indicator, and its operation is revealed only in conjunction with features such as the CPL.

### 7.5.3 Very High Frequency (VHF) protection

All FP+ Series amplifiers include protection circuits that detect continuous Very High Frequency content in the input signal. The detection begins at approximately 10 kHz and moves upwards to include ultrasonic signal. If VHF signals are detected, the output will mute for 6 seconds before re-measuring. Once no continuing VHF signal is detected, the output un-mutes and returns to normal operation.

This feature recognizes that continuous full-scale VHF signals do not appear in “natural” sources such as music. Any such signals can therefore be considered as a fault when present. VHF protection is essential in avoiding damage to high frequency drivers.

The VHF protection operational area is dependent on output power level and frequency. The illustration below shows a decreasing threshold on the output power level, starting at approximately 10 kHz and rising with a -6 dB slope. This defines the VHF protection area. When continuous output power above the threshold line is detected the VHF protection becomes active.

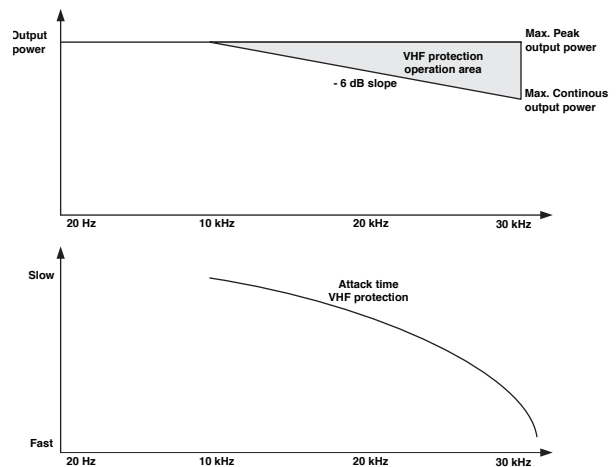

**Figure 7.5.3: VHF protection attack time vs output power/frequency**

The Attack time for the VHF protection is increasingly shorter at higher frequencies. For example, an ultrasonic continuous signal will cause the outputs to mute rapidly, where it will take several milliseconds for a 10 kHz continuous signal to trigger the output mute. This is shown in the illustration above.

The VHF protection is NOT a limiter and does not alter the amplifier’s frequency response. It is implemented solely to detect continuous VHF content. The amplifier will always pass VHF peaks at full power, with no effect on musical “transients”.

The VHF protection is indicated by a yellow LED on the amplifier front panel, with output muting for 6 seconds when in action. It is reported as a fault via the NomadLink network on the DeviceControl GUI.



If you bench test the amplifier using a continuous, full scale sine-wave input above 10 kHz, the VHF protection will activate and prevent measurement of full peak output power. (Output will be muted long before maximum output power is attained.) To measure the true peak output power, use a burst signal.

### 7.5.4 DC protection

DC protection is implemented on each output to prevent damage to connected loudspeakers. DC present at the output will trigger muting and illuminate the fault LED indicator. Any DC present at the output indicates a hardware malfunction that requires servicing of the amplifier.

### 7.5.5 High-impedance warning (open load)

A high-impedance (open load) condition is indicated when an input signal above approximately -29 dB is detected and no functioning loudspeakers are connected to the amplifier. The fault is indicated by an orange Sig/Hi-imp LED. The indicator is green when a valid load is present under the same input signal conditions



Since the Hi-impedance detection initially triggers only when the input signal rises above -29 dB, it might cause the indicator to first turn green, and then red, even in situations where no speaker is connected.

### 7.5.6 Low-impedance protection warning

A low impedance or short circuit fault is detected when current draw is high (Current Peak Limiter active) and when, simultaneously, output signal is low (-4 dB LED does not illuminate). When this occurs, the amplifier protects the output stage from damage by muting the output signal and bypassing the circuits. Indication of this fault is a constant orange illumination of the Current Peak Limiter (CPL) LED on the front panel. The protection will sequence at 6 second intervals to re-measure conditions. If the low-impedance fault is no longer detected, the amplifier will un-mute.



If the CPL turns constant orange, the output is muted, and the -4 dB signal LED is ON, then the amplifier has gone into maximum current protection. This situation is caused by an excessive input signal and is not due to a short circuit. Turn down the input signal to avoid or remedy this situation.

### 7.5.7 Temperature protection

Thermal measurement points are provided on each output channel as well as on the power supply. These indicators will, if the pre-specified temperature level is exceeded, give a high temperature warning. This warning condition is indicated by a flashing TEM LED on the front panel, and it is reported on the Device Control GUI via the NomadLink network.

As the amplifier approaches a thermal protection threshold, the warning LED sequence will start with short "on-time" bursts. If the amplifier continues to overheat and approaches the temperature limit, the flashing sequence will be defined by longer and

longer on-time bursts until the protection mode is activated.

If the temperature becomes too high to continue safe operation, the overheated output channel(s) will be muted until the temperature returns to an acceptable level.

Fully active temperature protection (with muting) is indicated by a constantly illuminated TEM LED. It will also be indicated as a fault via the NomadLink network on the DeviceControl GUI.

Temperature measurements will continue at 6 second intervals. The output will un-mute when the channel or power supply returns to a safe operating temperature.

### 7.5.8 Power Average Limiter (PAL)

The Power Average Limiter (PAL) controls the current-drawing relationship between the power supply and the mains inlet. PAL limits the maximum average power consumption according to the power supply capabilities, ensuring that the PSU will not overload. In addition, in the larger models that potentially could pull more current from the mains than the mains fuses are specified to handle (more than 16 A), PAL limits the amplifier's maximum current draw to prevent blowing the mains fuse.

### 7.5.9 Soft-Start

High powered amplifiers with inadequate inrush limiting can pull considerable current from the mains at turn-on. This can result in tripping of fast-acting mains breakers. Such is not the case with FP+ Series amplifiers. The FP+ Series amplifiers have very low inrush power as the capacitors are charged slowly and in a controlled manner ensuring that breakers will not trip.

Several amplifiers will, under normal conditions, be able to be powered up simultaneously. If you do experience problems powering up multiple amplifiers simultaneously, use the NomadLink network and/or the NLB 60E to establish a power sequence with a preset delay between the start-up of each subsequent amplifier.

## 7.6 Front-panel monitoring and adjustments

### 7.6.1 Level indicators

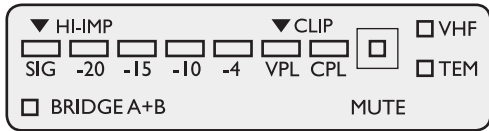

Figure 7.6.1: Front panel LED field (per-channel)

The front-panel displays an array of ten LED indicators for level and status monitoring of each amplifier channel. Indications related to signal levels are as follows:

- ▶ **Orange CPL (Current Peak Limiter)** flashing Indicates that output signal has reached the limit of the output devices and limiting is in effect.
- ▶ **Red VPL/CLIP** Indicates that signal has reached maximum output voltage. (Maximum voltage is determined by rear-panel VPL settings.)
- ▶ **Green SIG to -4** Indicates output signal levels in normal operating range
- ▶ **SIG + HI-IMP (green/orange)** Indicates input signal above -44 dB. Should the SIG indicator turn red, this indicates a “high-impedance” or open connection has been detected at the output. Possible faults include a disconnected cable or malfunctioning loudspeaker. (In some cases a normal condition, such as a sub-bass enclosure with high-impedance at a certain frequency, can trigger this indication.) If the -10 dB LED illuminates AND the HI-IMP LED turns orange, then the amplifier has detected an open load (no loudspeaker connected).

More detailed signal indications are available using the DeviceControl software application.

### 7.6.2 Level adjust

Level adjust potentiometers (one per channel) are located on the front panel adjacent to the LED display. The potentiometer’s operational range is 0 dB to minus infinity in 31 steps. Attenuation is logarithmic, with -10 dB at the 12 o’clock position. See table for levels at other increments.

Step	Attenuation
1 (Min)	-Inf. dB
2	-60.5 dB
3	-48.3 dB
4	-33.9 dB
5	-25.8 dB
6	-21.6 dB
7	-19.2 dB
8	-17.4 dB
9	-16.0 dB
10	-14.7 dB
11	-13.7 dB
12	-12.7 dB
13	-12.1 dB
14	-11.3 dB
15	-10.6 dB
16	-10.0 dB
17	-9.3 dB
18	-8.7 dB
19	-8.1 dB
20	-7.4 dB
21	-6.8 dB
22	-6.1 dB
23	-5.3 dB
24	-4.5 dB
25	-3.6 dB
26	-2.7 dB
27	-1.7 dB
28	-0.7 dB
29	-0.3 dB
30	-0.2 dB
31 (Max)	-0.0 dB

Table 7.6.2: Attenuation for front panel potentiometers in steps-to-dB levels

Note that it is not possible to adjust individual channel attenuation from the NomadLink network or elsewhere on the amplifier.

### 7.6.3 Mute indication

Individual channel Mute is indicated by illumination of the red MUTE LED provided for each channel. If only the red MUTE LED is illuminated and all other indications are normal, then the channel has been muted by a command from the NLB 60E front panel or the DeviceControl application. Otherwise, an illuminated MUTE LED could indicate a fault condition (see below).

## 7.6.4 Performance, Warning and Fault indicators

### Global Indicators:

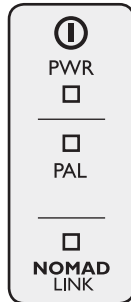

Figure 7.6.4a: Front panel global LED field

- ▶ **Power on/off** (green) indicates that mains power is switched on.
- ▶ **NomadLink** (blue) indicates that the network is connected. The NomadLink LED will light up even before the mains power is connected and switched on as it takes phantom power from the network cable.
- ▶ **PAL**, Power Average Limiter (red), indicates that the amplifier is limiting because the power supply and/or the mains-inlet fuse has reached maximum capability.

### Channel Indicators:

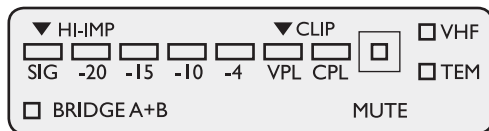

Figure 7.6.4b: Front panel LED field (per-channel)

- ▶ **Bridge mode** (yellow) indicates if two channels are bridged using the DIP-switch on the rear panel.
- ▶ **CPL**, Current Peak Limiter (orange), when flashing indicates the maximum possible current draw has been reached.
- ▶ **CPL**, Current Peak Limiter (orange), when constant indicates excessive current draw caused by a short circuit on the output or very low operational impedance. MUTE LED will illuminate and the output will mute for 6 seconds before re-measuring the output impedance. This will

continue until the short circuit is removed. CPL remains constant orange in a fault condition only when an input signal is present.

- ▶ **Temperature** (yellow) warning is indicated by a flashing LED. If the amplifier goes into thermal protect (output muted), the TEM LED illuminates constant yellow and the red MUTE LED illuminates.
- ▶ **VHF**, Very High Frequency protection (yellow) indicates that potentially harmful continuous high frequencies have been detected on the input signal. The output is muted (MUTE LED on).
- ▶ **Hardware fault** is indicated when both the CPL and TEM, VHF and MUTE indicators light up simultaneously. The amplifier requires servicing before placing back in operation.

## 7.7 NomadLink network and DeviceControl software

### 7.7.1 NomadLink network in the amplifiers

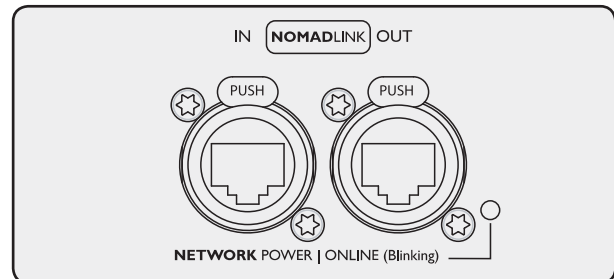

Figure 7.7.1: NomadLink Network RJ45 connectors

All FP+ Series amplifiers are equipped with the proprietary NomadLink network interface. This includes two EtherCon housed RJ45 connections: one IN and one OUT.

Use standard straight Cat-5 Ethernet cables with RJ45 connectors to connect the amplifier to the NLB 60E or to daisy-chain multiple amplifiers.





It is very important that two IN or two OUT ports are NEVER connected to each other. This will cause the NomadLink communication and DeviceControl to exhibit erratic behavior and display inaccurate data. However, this situation will not damage the amplifier circuitry.

Up to 60 amplifiers can be connected to one NLB 60E in a daisy-chain or closed loop.

When the NLB 60E is powered up, the NomadLink network receives phantom power. This causes the blue NomadLink LED on the amplifier front panel and the NomadLink LED on the rear panel to light up. NomadLink is active even when the amplifier has mains power disconnected or is not yet powered up.

The amplifier does not have a stand-by power supply for the network. The network is solely powered from the NLB 60E. Should an amplifier fail or be inadvertently disconnected from the mains, network integrity is fully maintained and all amplifiers remain visible on the system.

### 7.7.2 Connection and setup

The NomadLink network requires use of an NLB 60E NomadLink Bridge & Network Controller. The NomadLink network is established by connecting the NLB 60E OUT port to the first amplifier's IN port. Then a daisy-chain is established by connecting the first amplifier's OUT port to the next amplifier's IN port, and so on. If a closed loop network is desired for improved redundancy (highly recommended), the last amplifier's OUT port must be connected to the NLB 60E's IN port.

For all connections, straight Cat-5 RJ45-equipped Ethernet cables should be used.



To ensure full performance of your NLB 60E NomadLink Bridge & Network Controller with the expanded range of FP+ Series amplifiers, as well as full compatibility with Lab.gruppen's third party control protocol, please be sure that you are using the most up-to-date firmware. This is available for download at:

[www.labgruppen.com/index.php/support/software\\_firmware/](http://www.labgruppen.com/index.php/support/software_firmware/)

Please register at the website to gain access, and to allow us to inform you when updates are available.



Optimal NomadLink performance can only be assured when using Cat-5 cables. However, as NomadLink is only using two wires + ground for communication and phantom power it is possible to create converters from RJ45 to, for example, XLR connectors using 2-wire shielded cable. The NomadLink network can then be operated using a standard tie-line in a multicore signal distribution system. See the drawing below for an example of how to create a converter.

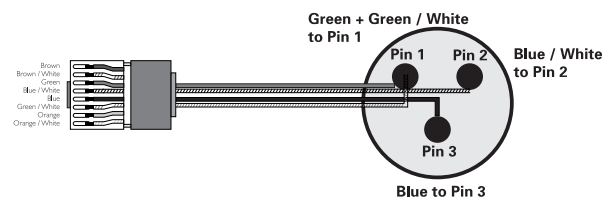

**Figure 7.7.2: NomadLink RJ45 to XLR wiring schematic**



If any cable format or connection other than Cat-5 (or better) and RJ45 is utilized, network performance may be compromised. In this event Lab.gruppen cannot guarantee that the NomadLink network will be fully operational.

### 7.7.3 NomadLink network cable lengths

In situations where the amplifiers and the NLB 60E will be positioned in different locations at some distance from each other, or where groups of amplifiers within a single subnet with up to 60 units will be installed with a distance in between, these general rules may be considered:

Below are typical examples of NomadLink network setups:

- ▶ **Rule 1:** The maximum cable length in between any two devices may not exceed 300 meters /

980 feet.

- ▶ **Rule 2:** In a non-closed-loop daisy-chained subnet the total maximum cable length is 400 meters / 1300 feet.
- ▶ **Rule 3:** In a closed-loop subnet the total maximum cable length is 700 meters / 2300 feet.

### 7.7.4 Ethernet network cable lengths

The connection between the NLB 60E and your PC is a standard Ethernet network running the TCP/IP protocol. Cable distances between NLB 60E and your PC follow standard rules for Ethernet systems.

Contact your IT expert for more details.

### 7.7.5 DeviceControl software

DeviceControl is Lab.gruppen’s proprietary software application for monitoring and controlling networked FP+ Series and other Lab.gruppen NomadLink-ready power amplifier. DeviceControl runs on a Windows PC, which connects via Ethernet to the NLB 60E NomadLink Bridge & Network Controller. DeviceControl provides comprehensive monitoring of amplifier status as well as control of amplifier power on/off and individual channel mute and solo functions.

Please review the DeviceControl Operation Manual for more detailed information.

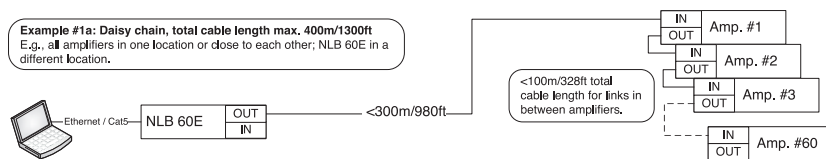

**Figure 7.7.5a: NomadLink daisy chain configuration**

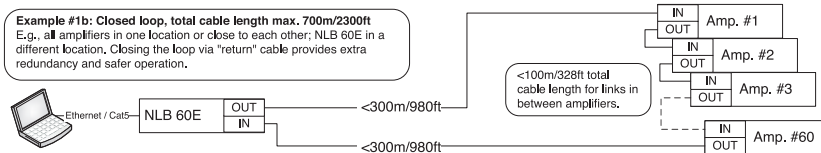

**Figure 7.7.5b: NomadLink closed loop configuration**

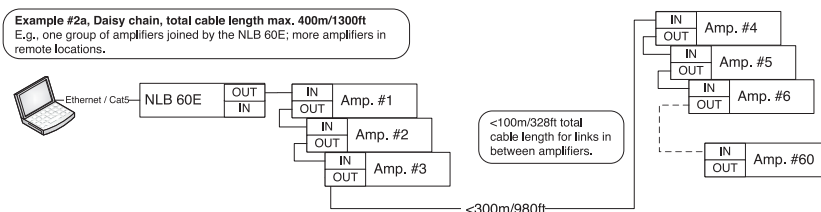

**Figure 7.7.5c: NomadLink closed loop daisy chain configuration**

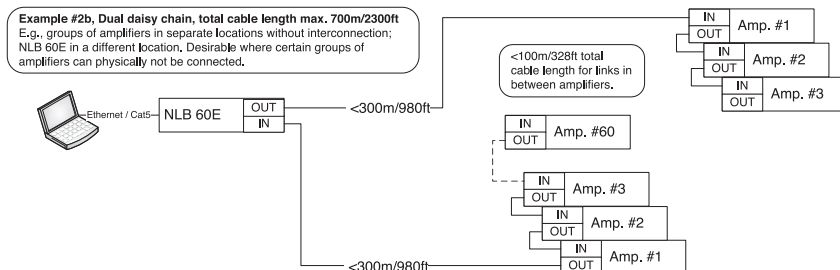

**Figure 7.7.5d. NomadLink dual daisy chain closed loop configuration**

---

## 8.1 Maintenance

---

During normal operation your FP+ Series amplifier will provide trouble-free service. The only user maintenance required is to periodically vacuum clean the foam dust-filters behind the front grille.

In some extreme cases it may be necessary for authorized service personnel to clean the inside of the amplifier. These conditions usually occur after prolonged use in extreme environments such as those using "cracked oil" smoke machines. If you are using your amplifier in a heavy duty application, it is recommended to have your amplifier serviced every 3 years purely as a preventative action.

---

## 8.2 FAQ

---

Following are common questions asked about Lab.gruppen FP+ Series power amplifiers together with helpful answers.

**Q:** What is the input sensitivity of the amplifiers?

**A:** Input sensitivity is calculated from the amplifier gain, maximum output voltage and load. As gain and output voltage is adjustable in FP+ Series amplifiers, you need to look this information up in a table found in the Appendix section of this manual. Input sensitivity also is automatically calculated in the DeviceControl software application.

**Q:** What are the maximum cable lengths allowed when using the NomadLink network?

**A:** NomadLink uses a daisy-chain topology to connect amplifiers and an NLB 60E in a network. Standard RJ45-equipped Cat-5 cables are used throughout. The daisy chain may be made into a closed-loop by connecting a return cable to the NLB 60E from the last amplifier.

General rules of cable lengths:

- ▶ The maximum cable length in between any two devices may not exceed 300 meters / 980 feet.
- ▶ In a non-closed-loop daisy-chained subnet the maximum cable length is 400 meters / 1300 feet.
- ▶ In a closed-loop subnet the maximum cable length is 700 meters / 2300 feet.

Exceeding these limits may result in lost contact with the devices, or loss of phantom powering due to cable resistance.

**Q:** How long can cable-runs be on the Ethernet network connecting the NLB 60E to the PC?

**A:** On the Ethernet side, normal Ethernet cable limits apply. This is typically a maximum of 80 meters / 300 feet between each device. Follow standard installation procedures for Ethernet. Distances beyond 100 meters may require use of a repeater, a format converter, or optical cables.

**Q:** Why is the NomadLink network a closed-loop topology?

**A:** Technically speaking, the closed loop is optional. The purpose of closing the loop is primarily to provide a secondary path to the amplifiers. If cables are broken or disconnected in either direction, all amplifiers still may be addressed by the network.

**Q:** How can I be sure that no protection circuits or safety functions interfere with the output signal?

**A:** If no Clip or Warning LEDs on the front panel light up, you can be fully confident that the rated maximum output power in the full frequency range is available for your speakers. No limiting or gain-reduction takes place without a warning or fault indication.

---

## 8.3 Additional documentation

---

In case you didn't find what you were looking for in this Operation Manual, check out the website at [www.labgruppen.com](http://www.labgruppen.com), where you can find a multitude of additional documentation for FP+ Series.

### 8.4 Current Draw and Thermal Dissipation specifications

The following tables contain information on measured current consumption as well as calculated heat dissipation during normal operation(1/8 rated power); and during extreme heavy duty operation (1/4 rated power).

FP 14000									
Level	Load	Rated power	Line Current *2)		Watt *1)			Thermal Dissipation	
			120 VAC	230 VAC	In	Out	Dissipated	BTU/hr	kCal/hr
Standby with remote power off via Nomadlink®					0	0	0	0	0
Power on, Idling					122	0	122	416	105
			Amp (I)		Watt				
Pink noise (1/8th rated power)	16 Ω / Ch.	1200 x 2	9.1	4.8	628	300	328	1118	282
	32 Ω / Bridged	2400 x 1							
	8 Ω / Ch.	2350 x 2	14.8	7.7	1081	588	493	1683	424
	16 Ω / Bridged	4700 x 1							
	4 Ω / Ch.	4400 x 2	23.9	12.5	1880	1100	780	2661	670
	8 Ω / Bridged	8800 x 1							
	<i>2 Ω / Ch. *4)</i>	<i>7000 x 2</i>	<i>34.0</i>	<i>17.8</i>	<i>2750</i>	<i>1750</i>	<i>1000</i>	<i>3412</i>	<i>860</i>
<i>4 Ω / Bridged *4)</i>	<i>14000 x 1</i>								
Pink noise (max power) *3)	16 Ω / Ch.	1200 x 2	16.0	8.4	1253	800	453	1546	390
	32 Ω / Bridged	2400 x 1							
	8 Ω / Ch.	2350 x 2	30.0	16.0	2259 / 2409	1500 / 1600	759 / 809	2589 / 2762	652 / 696
	16 Ω / Bridged	4700 x 1							
	4 Ω / Ch.	4400 x 2	30.0	16.0	2320 / 2474	1463 / 1560	857 / 914	2926 / 3121	737 / 786
	8 Ω / Bridged	8800 x 1							
	2 Ω / Ch.	7000 x 2	30.0	16.0	2277 / 2429	1266 / 1350	1012 / 1079	3453 / 3683	870 / 928
4 Ω / Bridged	14000 x 1								
Mains connector, 230 V CE version			16 A, CEE7						
Mains connector, 115 V ETL version			30 A, Twist lock						
*1) The amplifier's PSU operates as a non-resistive load, so the calculation "Volts x Amps = Watts" would not be correct. Instead, measured and specified here is what is known as the "Active Power" of the amplifier providing useful, real-world values of power consumption and heat dissipation.									
*2) Current draw figures measured at 230 V. 115 V figures are 230 V figures multiplied by two.									
*3) Figures measured at maximum sustainable power without tripping the mains fuse. Listed separately for 30 A/115 V and 16 A/230 V operation . Note that the max. power condition is very extreme and will not occur during normal operation. Also note that the mains breaker will not be tripped even if operation is <b>momentarily</b> in excess of max. ratings.									
*4) <i>Italics used for conditions that, if sustained over long time periods, may trigger the mains breaker. Therefore these measurements should not be used when calculating cooling requirements as they cannot be sustained by the mains breaker over time.</i>									

**Table 8.4a: FP 14000 Current Draw and Thermal Dissipation specifications**

FP 13000									
Level	Load	Rated power	Line Current *2)		Watt *1)			Thermal Dissipation	
			120 VAC	230 VAC	In	Out	Dissipated	BTU/hr	kCal/hr
Standby with remote power off via Nomadlink®					0	0	0	0	0
Power on, Idling					129	0	129	440	111
			Amp (I)		Watt				
<b>Pink noise (1/8th rated power)</b>	16 Ω / Ch.	1200 x 2	10.2	5.3	678	300	378	1289	325
	32 Ω / Bridged	2400 x 1							
	8 Ω / Ch.	2350 x 2	15.6	8.1	1083	588	495	1690	426
	16 Ω / Bridged	4700 x 1							
	4 Ω / Ch.	4400 x 2	25.4	13.2	1856	1100	756	2578	650
	8 Ω / Bridged	8800 x 1							
	<i>2 Ω / Ch. *4)</i>	<i>6500 x 2</i>	<i>36.2</i>	<i>18.9</i>	<i>2536</i>	<i>1625</i>	<i>911</i>	<i>3109</i>	<i>783</i>
<i>4 Ω / Bridged *4)</i>	<i>13000 x 1</i>								
<b>Pink noise (max power) *3)</b>	16 Ω / Ch.	1200 x 2	15.3	8.0	1037	800	237	807	203
	32 Ω / Bridged	2400 x 1							
	8 Ω / Ch.	2350 x 2	26.0	13.6	1840	1567	273	933	235
	16 Ω / Bridged	4700 x 1							
	4 Ω / Ch.	4400 x 2	30.0	16.0	2199 / 2249	1435 / 1487	764 / 763	2609 / 2603	657 / 656
	8 Ω / Bridged	8800 x 1							
	2 Ω / Ch.	6500 x 2	30.0	16.0	2041 / 2093	1227 / 1267	814 / 826	2778 / 2818	700 / 710
4 Ω / Bridged	13000 x 1								
Mains connector, 230 V CE version			16 A, CEE7						
Mains connector, 115 V ETL version			30 A, Twist lock						
*1) The amplifier's PSU operates as a non-resistive load, so the calculation "Volts x Amps = Watts" would not be correct. Instead, measured and specified here is what is known as the "Active Power" of the amplifier providing useful, real-world values of power consumption and heat dissipation.									
*2) Current draw figures measured at 230 V. 115 V figures are 230 V figures multiplied by two.									
*3) Figures measured at maximum sustainable power without tripping the mains fuse. Listed separately for 30 A/115 V and 16 A/230 V operation. Note that the max. power condition is very extreme and will not occur during normal operation. Also note that the mains breaker will not be tripped even if operation is <b>momentarily</b> in excess of max. ratings.									
*4) <i>Italics used for conditions that, if sustained over long time periods, may trigger the mains breaker. Therefore these measurements should not be used when calculating cooling requirements as they cannot be sustained by the mains breaker over time.</i>									

**Table 8.4b: FP 13000 Current Draw and Thermal Dissipation specifications**

FP 9000									
Level	Load	Rated power	Line Current *2)		Watt *1)			Thermal Dissipation	
			120 VAC	230 VAC	In	Out	Dissipated	BTU/hr	kCal/hr
Standby with remote power off via Nomadlink®					1	0	1	3	1
Power on, Idling					122	0	122	416	105
			Amp (I)		Watt				
Pink noise (1/8th rated power)	16 Ω / Ch.	800 x 2	6.7	3.5	477	200	277	944	238
	32 Ω / Bridged	1600 x 1							
	8 Ω / Ch.	1600 x 2	11.0	5.7	799	400	399	1362	343
	16 Ω / Bridged	3200 x 1							
	4 Ω / Ch.	3000 x 2	18.5	9.7	1398	750	648	2212	557
	8 Ω / Bridged	6000 x 1							
	2 Ω / Ch.	4500 x 2	26.3	13.7	2053	1125	928	3166	798
	4 Ω / Bridged	9000 x 1							
Pink noise (max power) *3)	16 Ω / Ch.	800 x 2	12.2	6.4	930	533	396	1352	341
	32 Ω / Bridged	1600 x 1							
	8 Ω / Ch.	1600 x 2	22.0	11.5	1707	1067	640	2185	550
	16 Ω / Bridged	3200 x 1							
	4 Ω / Ch.	3000 x 2	30.0	16.0	2278 / 2430	1419 / 1514	859 / 916	2931 / 3126	738 / 788
	8 Ω / Bridged	6000 x 1							
	2 Ω / Ch.	4500 x 2	30.0	16.0	2258 / 2409	1219 / 1300	1039 / 1109	3548 / 3784	894 / 953
	4 Ω / Bridged	9000 x 1							
Mains connector, 230 V CE version			16 A, CEE7						
Mains connector, 115 V ETL version			30 A, Twist lock						
*1) The amplifier's PSU operates as a non-resistive load, so the calculation "Volts x Amps = Watts" would not be correct. Instead, measured and specified here is what is known as the "Active Power" of the amplifier providing useful, real-world values of power consumption and heat dissipation.									
*2) Current draw figures measured at 230 V. 115 V figures are 230 V figures multiplied by two.									
*3) Figures measured at maximum sustainable power without tripping the mains fuse. Listed separately for 30 A/115 V and 16 A/230 V operation . Note that the max. power condition is very extreme and will not occur during normal operation. Also note that the mains breaker will not be tripped even if operation is momentarily in excess of max. ratings.									

**Table 8.4c: FP 9000 Current Draw and Thermal Dissipation specifications**

FP 7000									
Level	Load	Rated power	Line Current *2)		Watt *1)			Thermal Dissipation	
			120 VAC	230 VAC	In	Out	Dissipated	BTU/hr	kCal/hr
Standby with remote power off via Nomadlink®					0	0	0	0	0
Power on, Idling					92	0	92	316	80
			Amp (I)		Watt				
Pink noise (1/8th rated power)	16 Ω / Ch.	730 x 2	6.5	3.4	411	183	229	781	197
	32 Ω / Bridged	1460 x 1							
	8 Ω / Ch.	1450 x 2	10.4	5.4	692	363	329	1123	283
	16 Ω / Bridged	2900 x 1							
	4 Ω / Ch.	2800 x 2	16.8	8.7	1176	700	476	1625	409
	8 Ω / Bridged	5600 x 1							
	2 Ω / Ch.	3500 x 2	21.1	11.0	1518	875	643	2195	553
	4 Ω / Bridged	7000 x 1							
Pink noise (max power) *3)	16 Ω / Ch.	730 x 2	18.9	9.8	800	487	313	1070	270
	32 Ω / Bridged	1460 x 1							
	8 Ω / Ch.	1450 x 2	30.0	16.0	1425 / 1436	914 / 924	511 / 512	1744 / 1749	439 / 441
	16 Ω / Bridged	2900 x 1							
	4 Ω / Ch.	2800 x 2	30.0	16.0	2134 / 2183	1382 / 1419	753 / 763	2569 / 2605	647 / 656
	8 Ω / Bridged	5600 x 1							
	2 Ω / Ch.	3500 x 2	30.0	16.0	2316 / 2380	1526 / 1586	790 / 794	2696 / 2710	679 / 683
	4 Ω / Bridged	7000 x 1							
Mains connector, 230 V CE version			16 A, CEE7						
Mains connector, 115 V ETL version			30 A, Twist lock						
*1) The amplifier's PSU operates as a non-resistive load, so the calculation "Volts x Amps = Watts" would not be correct. Instead, measured and specified here is what is known as the "Active Power" of the amplifier providing useful, real-world values of power consumption and heat dissipation.									
*2) Current draw figures measured at 230 V. 115 V figures are 230 V figures multiplied by two.									
*3) Figures measured at maximum sustainable power without tripping the mains fuse. Listed separately for 30 A/115 V and 16 A/230 V operation. Note that the max. power condition is very extreme and will not occur during normal operation. Also note that the mains breaker will not be tripped even if operation is momentarily in excess of max. ratings.									

**Table 8.4d: FP 7000 Current Draw and Thermal Dissipation specifications**

FP 4000									
Level	Load	Rated power	Line Current *2)		Watt *1)			Thermal Dissipation	
			120 VAC	230 VAC	In	Out	Dissipated	BTU/hr	kCal/hr
Standby with remote power off via Nomadlink®				0.1	0.2	0	0	1	0
Power on, Idling				0.8	87	0	87	298	75
			Amp (I)		Watt				
Pink noise (1/8th rated power)	16 Ω / Ch.	400 x 2	3.9	2.0	262	100	162	552	139
	32 Ω / Bridged	800 x 1							
	8 Ω / Ch.	800 x 2	6.1	3.2	424	200	224	765	193
	16 Ω / Bridged	1600 x 1							
	4 Ω / Ch.	1600 x 2	10.7	5.6	782	400	382	1305	329
	8 Ω / Bridged	3200 x 1							
	2 Ω / Ch.	2000 x 2	14.2	7.4	1035	575	460	1569	395
	4 Ω / Bridged	4000 x 1							
Pink noise (max power) *3)	16 Ω / Ch.	400 x 2	7.0	3.7	499	267	232	793	200
	32 Ω / Bridged	800 x 1							
	8 Ω / Ch.	800 x 2	12.1	6.3	893	533	359	1227	309
	16 Ω / Bridged	1600 x 1							
	4 Ω / Ch.	1600 x 2	21.7	11.3	1681	1067	615	2098	529
	8 Ω / Bridged	3200 x 1							
	2 Ω / Ch.	2000 x 2	28.6	14.9	2226	1533	692	2363	595
	4 Ω / Bridged	4000 x 1							
Mains connector, 230 V CE version			16 A, CEE7						
Mains connector, 115 V ETL version			20 A, Nema 5-20P						
*1) The amplifier's PSU operates as a non-resistive load, so the calculation "Volts x Amps = Watts" would not be correct. Instead, measured and specified here is what is known as the "Active Power" of the amplifier providing useful, real-world values of power consumption and heat dissipation.									
*2) Current draw figures measured at 230 V. 115 V figures are 230 V figures multiplied by two.									
*3) Figures measured at maximum sustainable power without tripping the mains fuse. Listed separately for 30 A/115 V and 16 A/230 V operation. Note that the max. power condition is very extreme and will not occur during normal operation. Also note that the mains breaker will not be tripped even if operation is momentarily in excess of max. ratings.									

**Table 8.4e: FP 4000 Current Draw and Thermal Dissipation specifications**



FP 10000Q									
Level	Load	Rated Power	Line Current *2)		Watt *1)			Thermal Dissipation	
			120 VAC	230 VAC	In	Out	Dissipated	BTU/hr	kCal/hr
Standby with remote power off via Nomadlink®					0	0	0	0	0
Power on, Idling					139	0	139	475	120
			Amp (I)		Watt				
Pink noise (1/8th rated power)	16 Ω / Ch.	660 x 4	10.7	5.6	732	330	402	1371	345
	32 Ω / Bridged	1320 x 2							
	8 Ω / Ch.	1300 x 4	16.9	8.8	1224	650	574	1958	493
	16 Ω / Bridged	2600 x 2							
	4 Ω / Ch.	2100 x 4	25.9	13.5	1914	1050	864	2949	743
	8 Ω / Bridged	4200 x 2							
	2 Ω / Ch. *4)	2500 x 4	32.2	16.8	2414	1250	1164	3973	1001
4 Ω / Bridged *4)	5000 x 2								
Pink noise (max power) *3)	16 Ω / Ch.	660 x 4	13.6	7.1	1143	880	263	897	226
	32 Ω / Bridged	1320 x 2							
	8 Ω / Ch.	1300 x 4	22.4	11.7	2096	1733	363	1238	312
	16 Ω / Bridged	2600 x 2							
	4 Ω / Ch.	2100 x 4	30.0	16.0	2377 / 2455	1466 / 1542	910 / 914	3107 / 3118	783 / 716
	8 Ω / Bridged	4200 x 2							
	2 Ω / Ch.	2500 x 4	30.0	16.0	2237 / 2291	1099 / 1145	1139 / 1146	3886 / 3911	979 / 985
4 Ω / Bridged	5000 x 2								
Mains connector, 230 V CE version			16 A, CEE7						
Mains connector, 115 V ETL version			30 A, Twist lock						
*1) The amplifier's PSU operates as a non-resistive load, so the calculation "Volts x Amps = Watts" would not be correct. Instead, measured and specified here is what is known as the "Active Power" of the amplifier providing useful, real-world values of power consumption and heat dissipation.									
*2) Current draw figures measured at 230 V. 115 V figures are 230 V figures multiplied by two.									
*3) Figures measured at maximum sustainable power without tripping the mains fuse. Listed separately for 30 A/115 V and 16 A/230 V operation. Note that the max. power condition is very extreme and will not occur during normal operation. Also note that the mains breaker will not be tripped even if operation is <b>momentarily</b> in excess of max. ratings.									
*4) <i>Italics used for conditions that, if sustained over long time periods, may trigger the mains breaker. Therefore these measurements should not be used when calculating cooling requirements as they cannot be sustained by the mains breaker over time.</i>									

**Table 8.4f: FP 10000Q Current Draw and Thermal Dissipation specifications**

FP 6000Q									
Level	Load	Rated power	Line Current *2)		Watt *1)			Thermal Dissipation	
			120 VAC	230 VAC	In	Out	Dissipated	BTU/hr	kCal/hr
Standby with remote power off via Nomadlink®					0	0	0	0	0
Power on, Idling					134	0	134	456	115
			Amp (I)		Watt				
Pink noise (1/8th rated power)	16 Ω / Ch.	320 x 4	6.7	3.5	423	160	263	898	226
	32 Ω / Bridged	640 x 2							
	8 Ω / Ch.	625 x 4	10.5	5.4	700	313	388	1323	333
	16 Ω / Bridged	1250 x 2							
	4 Ω / Ch.	1250 x 4	17.3	9.0	1215	625	590	2015	508
	8 Ω / Bridged	2500 x 2							
	2 Ω / Ch.	1500 x 4	21.9	11.4	1575	750	825	2817	710
	4 Ω / Bridged	3000 x 2							
Pink noise (max power) *3)	16 Ω / Ch.	320 x 4	11.4	5.9	771	427	344	1175	296
	32 Ω / Bridged	640 x 2							
	8 Ω / Ch.	625 x 4	19.2	10.0	1402	833	569	1942	489
	16 Ω / Bridged	1250 x 2							
	4 Ω / Ch.	1250 x 4	30.0	16.0	2249 / 2305	1310 / 1350	939 / 955	3203 / 3261	807 / 822
	8 Ω / Bridged	2500 x 2							
	2 Ω / Ch.	1500 x 4	30.0	16.0	2244 / 2300	1329 / 1384	915 / 916	3122 / 3125	786 / 787
	4 Ω / Bridged	3000 x 2							
Mains connector, 230 V CE version			16 A, CEE7						
Mains connector, 115 V ETL version			30 A, Twist lock						
*1) The amplifier's PSU operates as a non-resistive load, so the calculation "Volts x Amps = Watts" would not be correct. Instead, measured and specified here is what is known as the "Active Power" of the amplifier providing useful, real-world values of power consumption and heat dissipation.									
*2) Current draw figures measured at 230 V. 115 V figures are 230 V figures multiplied by two.									
*3) Figures measured at maximum sustainable power without tripping the mains fuse. Listed separately for 30 A/115 V and 16 A/230 V operation. Note that the max. power condition is very extreme and will not occur during normal operation. Also note that the mains breaker will not be tripped even if operation is momentarily in excess of max. ratings.									

**Table 8.4g: FP 6000Q Current Draw and Thermal Dissipation specifications**

Following are the FP+ Series technical specifications. These figures are accurate at the time of printing but please note that all figures are subject to change without notice. For the most accurate and current information available, please visit [www.labgruppen.com](http://www.labgruppen.com).

Model	FP 14000	FP 13000	FP 9000	FP 7000	FP 4000	FP 10000Q	FP 6000Q
Number of channels	2	2	2	2	2	4	4
Peak total output all channels driven	14000 W	13000 W	9000 W	7000 W	4000 W	10000 W	6000 W
Peak output voltage per channel	195 V	195 V	170 V	155 V	121 V	150 V	101 V
Max. output current per channel	85 A peak	82 A peak	70 A peak	59 A peak	50 A peak	54 A peak	38 A peak
<b>Max. Output Power</b>							
16 ohms per ch. (all ch.'s driven)	1200 W	1200 W	800 W	730 W	400 W	660 W	320 W
8 ohms per ch. (all ch.'s driven)	2350 W	2350 W	1600 W	1450 W	800 W	1300 W	625 W
4 ohms per ch. (all ch.'s driven)	4400 W	4400 W	3000 W	2800 W	1600 W	2100 W	1250 W
2 ohms per ch. (all ch.'s driven)	7000 W	6500 W	4500 W	3500 W	2000 W	2500 W	1500 W
16 ohms Bridged per ch.	4700 W	4700 W	3200 W	2900 W	1600 W	2600 W	1250 W
8 ohms Bridged per ch.	8800 W	8800 W	6000 W	5600 W	3200 W	4200 W	2500 W
4 ohms Bridged per ch.	14000 W	13000 W	9000 W	7000 W	4000 W	5000 W	3000 W
2 ohms Bridged per ch.	3)	3)	3)	3)	3)	3)	3)
<b>Performance with Gain</b>							
	35 dB and VPL: 195 V	35 dB and VPL: 195 V	35 dB and VPL: 170 V	35 dB and VPL: 155 V	35 dB and VPL: 121 V	35 dB and VPL: 150 V	35 dB and VPL: 101 V
THD 20 Hz - 20 kHz for 1 W	<0.1%	<0.1%	<0.1%	<0.1%	<0.1%	<0.1%	<0.1%
THD at 1 kHz and 1 dB below clipping	<0.05%	<0.05%	<0.05%	<0.05%	<0.05%	<0.05%	<0.05%
Signal To Noise Ratio	>112 dBA	>112 dBA	>112 dBA	>112 dBA	>112 dBA	>112 dBA	>112 dBA
Channel separation (Crosstalk) at 1 kHz	>70 dB	>70 dB	>70 dB	>70 dB	>70 dB	>70 dB	>70 dB
Frequency response (1 W into 8 ohms) +0/-3 dB	2 Hz - 34.2 kHz	6.8 Hz - 34 kHz	2 Hz - 34.2 kHz	6.8 Hz - 34 kHz	2 Hz - 34.2 kHz	6.8 Hz - 34 kHz	6.8 Hz - 34 kHz
Input Impedance	20 kOhm	20 kOhm	20 kOhm	20 kOhm	20 kOhm	20 kOhm	20 kOhm
Input Common Mode Rejection, CMR	54 dB	54 dB	54 dB	54 dB	54 dB	54 dB	54 dB
Output impedance @ 100 Hz	19 mOhm	19 mOhm	19 mOhm	19 mOhm	32 mOhm	32 mOhm	32 mOhm
<b>Voltage Peak Limiter (VPL), max. peak output</b>							
VPL, selectable per ch. (V)	195, 170, 140, 116, 100, 80, 66, 54 V	195, 170, 140, 116, 100, 80, 66, 54 V	170, 140, 116, 100, 80, 66, 54 V	155, 121, 101, 83, 70, 56, 47, 38 V	121, 101, 83, 70, 56, 47, 38 V	150, 121, 101, 83, 70, 56, 47, 38 V	101, 83, 70, 56, 47, 38 V
VPL, selectable when bridged (V) <sup>1)</sup>	390, 340, 280, 232, 200, 160, 132, 108 V	390, 340, 280, 232, 200, 160, 132, 108 V	340, 280, 232, 200, 160, 132, 108 V	310, 242, 202, 166, 140, 112, 94, 76 V	242, 202, 166, 140, 112, 94, 76 V	300, 242, 202, 166, 140, 112, 94, 76 V	202, 166, 140, 112, 94, 76 V
Voltage Peak Limiter mode (per ch.)	Hard / Soft						
<b>Gain and Level</b>							
Amplifier gain selectable (all channels) <sup>1)</sup> – rear-panel switches	23, 26, 29, 32, 35, 38, 41, 44 dB						
Default gain	38 dB	35 dB	38 dB	35 dB	35 dB	35 dB	35 dB
Level adjustment (per ch.)	Front-panel potentiometer, 31 position detented from -inf to 0 dB						
<b>Connectors and switches</b>							
Input connectors (per ch.)	3-pin XLR, electronically balanced						
Output connectors (per ch.)	Neutrik Speakon or Binding Posts (must be specified upon order). BP only on FP 14000, FP 13000, FP 9000.						
Output bridge mode per two ch.'s	A+B - Ch. A is signal input source. A+B, C+D - Ch.'s A and C are input source						
NomadLink network	2 x RJ45 EtherCon connectors, IN and OUT						
Intelligent fans (on/off)	Yes, depending on presence of output signal						
Power on/off and Remote enable on/off	Individual switches on front-panel						
Cooling	Two fans, front-to-rear airflow, temperature controlled speed						
<b>Front-panel indicators</b>							
Common	NomadLink network; Power Average Limiter (PAL) <sup>2)</sup> ; Power on						
Per channel	Signal present / High-impedance; -20 dB, -15 dB, -10 dB and -4 dB output signal; Voltage Peak Limiter (VPL); Current Peak Limiter (CPL); Very High Frequency (VHF); High temperature; Fault; Mute						
<b>Power</b>							
Operating voltage, 230 V / 115 V nominal <sup>4)</sup>	130-265 V / 65-135 V						
Minimum power-up voltage, 230 V / 115 V	171 V / 85 V						
Power Average Limiter (PAL) <sup>2)</sup>	Yes						
Soft start / Inrush Current Draw	Yes / max. 5 A						
Mains connector	230 V CE: 16 A, CEE7; 115 V ETL: 30 A Twist lock   FP 4000: 230 V CE: 16 A, CEE7; 115 V ETL: 20 A / NEMA 5-20P						
<b>Dimensions (W/H/D)</b>							
	W: 483 mm (19"), H: 88 mm (2 U), Overall D: 396 mm (15.6"), Mounting D: 358 mm (14.1")						
<b>Weight</b>	12 kg (26.4 lbs.)						
<b>Finish</b>	Black painted steel chassis with black painted steel / aluminum front						
<b>Approvals</b>							
	CE, ANSI/UL 60065 (ETL), CSA C22.2 NO. 60065, FCC						

**Note 1):** Automatic -6 dB gain compensation when bridging channels.

**Note 2):** PAL can reduce the maximum output power to keep the power supply operating safely, and/or to prevent excessive current draw tripping the mains breaker. Refer to section 7.5.8 Power Average Limiter (PAL) for more information.

**Note 3):** The amplifier will be fully operational at bridge-mode 2 ohm loads, but due to physical constraints in the construction, the max. output power will not be significantly higher than running individual channels and therefore not stated here.

**Note 4):** Separate 230 V or 115 V versions available. Not selectable on the amplifier.

All specifications are subject to change without notice.

**General**

This product is manufactured by Lab.gruppen, and it is warranted to be free from any defects caused by components or factory workmanship, under normal use and service, for a period of six (6) years from date of purchase from an authorized Lab.gruppen dealer.

If the product fails to perform as specified during the warranty period, Lab.gruppen will undertake to repair, or at its option, replace this product at no charge to its owner, provided the unit is returned undamaged, shipping prepaid, to an authorized service facility or to the factory.

This warranty shall be null and void if the product is subjected to: repair work or alteration by a person other than those authorized by us; mechanical damage including shipping accidents; war, civil insurrection, misuse or abuse; operation with incorrect AC voltage, incorrect connections or accessories; operation with faulty associated equipment; or exposure to inclement weather conditions. Damage due to normal wear and tear is not covered by the warranty. Units on which the serial number has been removed or defaced will not be eligible for warranty service.

Lab.gruppen shall not be responsible for any incidental or consequential damages. Lab.gruppen's responsibility is limited to the product itself. Lab.gruppen takes no responsibility for any loss due to cancellation of any events, or rent of replacement equipment or costs due to a third party's or customer's loss of profit, or any other indirect cost or losses however incurred.

Lab.gruppen reserves the right to make changes or improvements in design or manufacturing without assuming any obligation to change or improve products previously manufactured.

This warranty is exclusive, and no other warranty is expressed or implied. This warranty does not affect the customer's statutory rights.

**International warranties**

Please contact your supplier or distributor for this information, as rights and disclaimers may vary from country to country.

**Technical assistance and service****International**

If your Lab.gruppen product requires repair, contact your Lab.gruppen dealer or distributor, or contact Lab.gruppen by fax or email to obtain the location of the nearest authorized service centre.

**Factory service**

In the event Lab.gruppen product requires factory service, you may contact Lab.gruppen's service department for return instructions and a Return Authorization number.

Please note for product return:

1. Use the original packing.
2. Include a copy of the sales receipt, your name, return address, phone and fax number, email address and description of the defect.
3. Mark the Return Authorization number on the outside of the packing.
4. Ship the product prepaid to:

Lab.gruppen AB  
Faktorvägen 1  
SE-434 37 Kungsbacka  
SWEDEN  
Phone: +46 300 56 28 00  
Fax: +46 300 56 28 99

support@labgruppen.com  
info@labgruppen.com  
www.labgruppen.com



# LAB.GRUPPEN

LAB.GRUPPEN AB ▶ SWEDEN  
 INTERNATIONAL CONTACT ▶ [INFO@LABGRUPPEN.COM](mailto:INFO@LABGRUPPEN.COM)  
 US & CANADA CONTACT ▶ [INFO@TCG-AMERICAS.COM](mailto:INFO@TCG-AMERICAS.COM)  
[WWW.LABGRUPPEN.COM](http://WWW.LABGRUPPEN.COM)