

apollo | x8

Thunderbolt 3 Audio Interface



Apollo x8 Hardware Manual

Manual Version 181126



UNIVERSAL AUDIO

www.uaudio.com

A Letter from Bill Putnam Jr.

Thank you for choosing this Apollo X Series audio interface to become a part of your studio. We know that any new piece of gear requires an investment of time and money — and our goal is to make your investment pay off.

Universal Audio interfaces like Apollo X exemplify a commitment to craftsmanship that we've forged over the past 60 years — from our original founding in the 1950s by my father, Bill Putnam Sr., to our current mission combining the best of both classic analog and modern digital audio technologies.

Starting with its ultra high-quality I/O and superior A/D and D/A conversion, Apollo X is designed to set new benchmarks in sonic performance. Breakthrough fidelity is just the beginning, however, as Apollo X's onboard HEXA Core processing lets you power the full range of UAD plug-ins, including classic mic preamps, EQs, dynamics processors, reverbs, guitar amps, and much more. With more than 100 acclaimed UAD plug-ins at your fingertips, the sonic choices are limitless.

At UA, we are dedicated to the idea that technology should serve the creative process, inspiring our customers to go further. These are the ideals my father embodied with his classic designs, and we like to think this spirit lives on today in products like Apollo X.

Please feel free to reach out to us via our website www.uaudio.com, and via our social media channels. We look forward to hearing from you, and thank you once again for choosing Universal Audio.

Sincerely,

A handwritten signature in black ink, appearing to read 'Bill Putnam Jr.', with a stylized, cursive script.

Bill Putnam Jr.

Table Of Contents

Tip: Click any section or page number to jump directly to that page.

A Letter from Bill Putnam Jr.	2
Introduction	4
Apollo x8 Thunderbolt 3 Audio Interface	4
Apollo x8 Features	7
Apollo x8 Documentation Overview	10
Additional Resources	11
Front Panel	12
Rear Panel	24
Digital I/O	25
Analog I/O	28
Interconnections.....	31
Installation Notes	31
Connection Notes	31
Typical Setup	33
Apollo Expanded: Multi-Unit Thunderbolt 3 Wiring.....	34
Software Setup.....	35
Specifications	36
Block Diagram.....	40
Troubleshooting	41
Notices.....	42
Warranty	42
Repair Service.....	42
Maintenance	42
Important Safety Information	43
Technical Support.....	46
Universal Audio Knowledge Base.....	46
YouTube Support Channel.....	46
Universal Audio Community Forums	46
Contact Universal Audio Support.....	46

Introduction

Apollo x8 Thunderbolt 3 Audio Interface

Elite-Class Audio Conversion with Four Unison Mic Preamps, HEXA Core Processing, and Surround Sound Monitoring.

Apollo x8 allows music producers, project, and post-production studios to track, overdub, and mix with new world-beating A/D and D/A conversion, HEXA Core UAD plug-in processing, and 7.1 surround sound monitoring — all in a sleek rackmount Thunderbolt 3 audio interface for Mac or PC.

Built upon UA's 60-year heritage of audio craftsmanship, this 18 x 24 interface distinguishes itself with four Unison™-enabled mic preamps, providing authentic emulations of preamps from Neve, API, Manley, Helios, SSL and more, plus all-new HEXA Core processing — yielding 50% more DSP for running UAD Powered Plug-Ins in real time.

In addition to its elite-class audio conversion, Apollo x8 features selectable operating level for compatibility with professional +24 dBu gear, as well as integrated monitor controller features and a built-in talkback mic.

- Experience elite-class A/D and D/A conversion nearing the widest dynamic range and lowest signal to noise available — at any price
- Track and mix with powerful HEXA Core processing, featuring 6 UAD DSP chips for running more award-winning UAD Powered Plug-Ins in real time
- Record with near-zero latency through preamp emulations from Neve, API, Manley, Fender, and more using Unison™ technology*
- Easily connect to pro-level studio gear with switchable +24 / +20 dBu headroom settings
- Work in surround formats up to 7.1, complete with speaker calibration and fold-down monitoring
- Integrated talkback and built-in cues for easy communication and slating takes

**All trademarks are recognized as property of their respective owners. Individual UAD Powered Plug-Ins sold separately.*

Elite-Class A/D and D/A Conversion

With thousands of chart-topping songs and hundreds of Grammy-winning albums under their belt, Apollo interfaces are no strangers to tracking stellar-sounding records. To improve on the previous generation Apollo interface's class-leading audio conversion, UA engineers obsessively auditioned the latest A/D and D/A converters — ultimately pairing elite-class 24-bit/192 kHz converters with all-new analog circuitry for an ultra-pristine signal path.

With 129 dB dynamic range and -118 dB THD+N, Apollo x8's open, natural sound quality rivals any dedicated high-end converter on the market — regardless of price — and is the perfect starting point for applying UAD processing.

Realtime UAD HEXA Core Processing

Apollo x8 features new HEXA Core processing, with six DSP chips and 50% more UAD plug-in processing power than previous Apollos. This lets you run more UAD plug-ins, whether you're tracking in real time with channel strips from Neve, Manley, or API, or running high UAD plug-in counts when mixing in your DAW.

From the tube warmth of Pultec EQs on guitars to the musical tube limiting of the LA-2A on vocals, or the pump of a genuine 1176 or Fairchild 670 tube compressor on drums, your recordings will take a giant leap forward with a rich, three-dimensional analog sound that UAD plug-ins provide.

Unison™ Technology: The Genuine Sound of Neve, API, & Manley Preamps

Perfect for musicians, engineers, producers, and sound designers, Apollo x8 features four Unison-enabled mic preamps, letting you track through exacting mic preamp emulations from Neve, API, Manley, SSL, Helios, and Universal Audio.* A Universal Audio exclusive, Unison technology nails the tone of these sought-after tube and solid state mic pres — including their input impedance, gain stage “sweet spots,” and the component-level circuit behaviors of the original hardware.

The secret to Unison is its hardware-software integration between Apollo's mic preamps and its onboard Realtime UAD processing.

A Full Suite of Classic Analog Processing Onboard

Of course, a hallmark feature of Apollo is its Realtime UAD Processing, letting you run the full library of UAD plug-ins with near-zero latency. Apollo x8 includes the Realtime Analog Classics Plus plug-in bundle, so you can record and mix with the world's only authentic Teletronix LA-2A, 1176LN, and Fairchild compressors, the Unison-enabled UA 610-B Tube Preamp & EQ, and guitar and bass amps from Marshall and Ampeg.

Access the World of UAD Powered Plug-Ins

Going beyond the included Realtime Analog Classics Plus plug-ins, Apollo x8 lets you tap into the full UAD Powered Plug-In library of name-brand vintage EQs, compressors, reverbs, tape machines, channel strips, and more — at near-zero latency, regardless of your audio software's buffer size and without taxing your computer's CPU.

**All trademarks are recognized as property of their respective owners. Individual UAD Powered Plug-Ins sold separately.*

With exclusive emulations from SSL, Neve, Studer, Manley, API, Ampex, Lexicon, Fender, Helios, and more,* it's like having a studio full of iconic analog gear, in a single rack space. And unlike competing interfaces, these award-winning DSP-powered plug-ins are also available in your DAW for mixing.

Surround Sound Monitoring and +24 dBu Operation

With comprehensive surround monitoring support for formats up to 7.1, Apollo x8 is a boon for engineers and producers working on audio and music for video games, television, and the web. In addition, Apollo x8 offers selectable +24 dBu operation for out-of-the-box compatibility with professional mixing consoles and other high-end pro audio equipment.

Build a Networked Studio System Over Thunderbolt

Apollo x8 offers 18 x 24 simultaneous inputs/outputs (8 x 14 analog I/O) and two built-in Thunderbolt 3 ports. This allows users of any Thunderbolt-equipped Apollo Twin or Apollo rackmount audio interfaces to easily combine up to four Apollos and six total UAD-2 devices — adding fast, high-bandwidth I/O and DSP as your studio grows.

**All trademarks are recognized as property of their respective owners. Individual UAD Powered Plug-Ins sold separately.*

Apollo x8 Features

Key Features:

- 18 x 24 Thunderbolt 3 audio interface with class-leading 24-bit/192 KHz conversion (backwards compatible with Thunderbolt 1 & 2 on Mac)
- Realtime UAD HEXA Core Processing for tracking through UAD plug-ins at near-zero latency, regardless of audio buffer size
- Record through 4 Unison-enabled mic/line preamps — giving you fully authentic preamp emulations from Neve, API, Manley, SSL, and more*
- Surround monitor controller up to 7.1 format
- Includes “Realtime Analog Classics Plus” UAD plug-in bundle featuring UA 610-B Tube Preamp; Legacy Pultec EQ, LA-2A, and 1176 compressors; Marshall Plexi Classic; Ampeg SVT-VR Classic, and more
- UAD HEXA Core processing onboard for additional mixing horsepower for Pro Tools, Logic, Cubase, Ableton, and other major DAWs
- Combine up to 4 Thunderbolt-equipped Apollos and 6 total UAD devices
- Selectable +24 dBu operation for easy compatibility with professional mixing consoles and tape machines
- Convenient front panel monitoring functions including Alt Speakers, Talkback mic, and assignable Dim or Mono
- Uncompromising UA analog design, superior components, and premium build quality
- Free, industry-leading technical support — on the phone and online — from knowledgeable audio engineers

Audio Interface Features

- Sample rates up to 192 kHz at 24-bit word length
- 18 x 24 simultaneous input/output channels
- Eight channels of analog-to-digital conversion via mic, line, or high-impedance inputs
- 14 channels of digital-to-analog conversion via:
 - Eight mono line outputs
 - Stereo monitor outputs
 - Two stereo headphone outputs
- 10 channels of digital I/O via:
 - Eight channels ADAT Optical I/O with S/MUX for high sample rates
 - Two channels coaxial S/PDIF I/O with sample rate conversion
- Two Thunderbolt 3 ports facilitates daisy-chaining of other Thunderbolt devices

Microphone Preamplifiers

- Four high-resolution, ultra-transparent, digitally-controlled analog mic preamps
- Unison™ technology for deep integration with UAD preamp, amp, and pedal plug-ins
- Front panel and software control of all preamp parameters
- Switchable low cut filter, 48V phantom power, pad, polarity inversion, and stereo linking

Monitoring

- Stereo monitor outputs (independent of the eight line outputs)
- Front panel control of monitor levels and muting
- Two stereo headphone outputs with independent mix buses
- Independent front panel volume controls for headphone outputs
- Front panel pre-fader metering of monitor bus levels
- S/PDIF outputs can be set to mirror the monitor outputs
- Up to two alternate stereo monitor outputs selectable via front panel or Console software
- Assignable front panel monitor function switch for alternate speakers, dim, & mono

UAD-2 Inside

- HEXA DSP featuring six SHARC® processors
- Realtime UAD Processing on all analog and digital inputs
- Same features and functionality as other UAD-2 devices when used with DAW
- Can be combined with other UAD-2 devices for increased mixing DSP
- Includes UAD Powered Plug-Ins “Realtime Analog Classics Plus” bundle
- Complete UAD Powered Plug-Ins library is available at the UA online store

Software

Console application:

- Analog-style control interface for realtime monitoring and tracking
- Enables Realtime UAD Processing with UAD plug-ins
- Remote control of Apollo x8 features and functionality
- Virtual I/O for routing DAW tracks through Console

Console Recall plug-in:

- Saves Console configurations inside DAW sessions for easy recall
- Convenient access to Console's monitor controls via DAW plug-in
- VST, RTAS, AAX 64, and Audio Units plug-in formats

UAD Meter & Control Panel application:

- Configures global UAD settings and monitors system usage

Other

- Easy firmware updates
- 1U rack-mountable form factor
- One year warranty includes parts and labor

Apollo x8 Documentation Overview

Documentation for Apollo x8 and UAD Powered Plug-Ins are separated by areas of functionality, as described below. The user manuals are placed on the system drive during software installation, and they can be downloaded at help.uaudio.com.

Apollo Manual Files

Note: All manual files are in PDF format. PDF files require a free PDF reader application such as [Acrobat Reader](#) (Mac & Windows) or [Preview](#) (Mac).

Apollo Hardware Manuals

Each Apollo model has a unique hardware manual. The Apollo hardware manuals contain complete hardware-related details about one specific Apollo model. Included are detailed descriptions of all hardware features, controls, connectors, and specifications.

Note: Each hardware manual contains the unique Apollo model in the file name.

Apollo Software Manual

The Apollo Software Manual is the companion guide to the Apollo hardware manuals. It contains detailed information about how to configure and control all Apollo software features using the Console application, Console Settings window, and Console Recall plug-in. Refer to the Apollo Software Manual to learn how to operate the software tools and integrate Apollo's functionality into the DAW environment.

Note: Each Apollo connection protocol (Thunderbolt, FireWire, USB) has a unique software manual.

UAD System Manual

The UAD System Manual is the complete operation manual for Apollo's UAD-2 functionality and applies to the entire UAD-2 product family. It contains detailed information about installing and configuring UAD devices, the UAD Meter & Control Panel application, buying optional plug-ins at the UA online store, and more. It includes everything about UAD except Apollo-specific information and individual UAD plug-in descriptions.

UAD Plug-Ins Manual

The features and functionality of all individual UAD Powered Plug-Ins is detailed in the UAD Plug-Ins Manual. Refer to this document to learn about the operation, controls, and user interface of each UAD plug-in that is developed by Universal Audio.

Direct Developer Plug-In Manuals

UAD Powered Plug-Ins includes plug-in titles created by our Direct Developer partners. Documentation for these 3rd-party plug-ins are separate files written and provided by the plug-in developers. The file names for these plug-in manuals are the same as the plug-in titles.

Accessing Installed Documentation

Any of these methods can be used to access installed documentation:

- Choose “Documentation” from the Help menu within the Console application
- Click the “Product Manuals” button in the Help panel within the UAD Meter & Control Panel application
- Manuals are also available online at help.uaudio.com

Host DAW Documentation

Each host DAW software application has its own particular methods for configuring and using audio interfaces and plug-ins. Refer to the host DAW’s documentation for specific instructions about using audio interface and plug-in features within the DAW.

Additional Resources

For additional resources, or if you need to contact Universal Audio for assistance, see the [Technical Support](#) page.

Front Panel

This section describes the features and functionality of all controls and visual elements on the Apollo x8 front panel.

Tip: All front panel functions (except the *METER* switch, headphone volume knobs, and power switch) can be controlled remotely with the included Console software application. Changes made with the front panel controls are mirrored in the Console application, and vice versa.

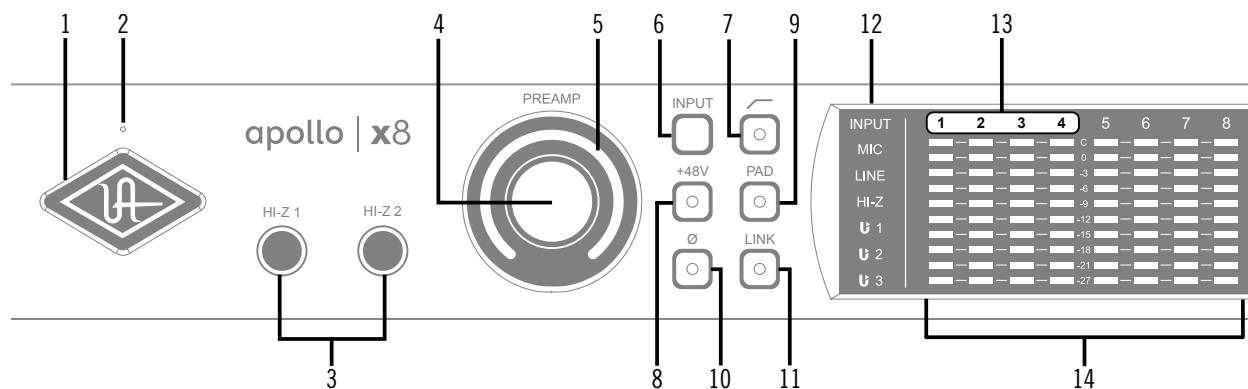

Apollo x8 front panel (left portion)

(1) Power Indicator (UA Logo)

The Universal Audio logo illuminates when the external power supply is properly connected to the AC outlet and the power input on the rear of the unit, and the Power switch (#27) is in the up position.

(2) Talkback Microphone

The built-in talkback mic is located inside of this hole. The talkback function is configured and operated in the included Console software application.

Caution: The talkback microphone is sensitive. To avoid equipment damage, do not insert any object into the mic hole, apply pressurized air into the mic hole, or use a vacuum over the mic hole.

(3) Hi-Z Inputs 1 & 2

The Hi-Z (high impedance) JFET direct inputs are for connecting low-level passive devices such as electric guitar and bass instruments into channels 1 & 2 for A/D conversion. Hi-Z input gain levels are adjusted with the Preamp control for the associated channel.

The Hi-Z inputs have a default input impedance of 1M Ohms. The input impedance may vary when Unison plug-ins are inserted on the channel within the Console application. For details, see the Unison chapter in the [Apollo Software Manual](#).

Important: Connect only ¼" unbalanced TS mono phone plugs to the Hi-Z inputs. TRS stereo plugs cannot be used.

Automatic Input Detection

Hi-Z inputs 1 & 2 use the same A/D converter channels as the corresponding Mic 1 & 2 and Line 1 & 2 inputs. When a device is plugged into a Hi-Z input, the Mic and Line inputs for the channel are overridden, the Mic/Line switch for the channel has no effect, and the stereo link is severed (if active).

Important: To use Mic or Line inputs 1 or 2, its corresponding Hi-Z input must be disconnected.

(4) Preamp Gain & Channel Select Knob

This rotary encoder with integrated switch has three functions:

Rotate – Rotating the knob adjusts the preamp gain for the selected input channel.

Press – Pressing the knob selects which preamp channel (1 – 4) is adjusted by the front panel preamp controls.

Press+Hold – When a Unison plug-in is active in the channel's dedicated Unison insert within the Console application, pressing and holding the knob for two seconds enters/exits Unison Gain Stage Mode.

Each of these three functions above is explained in greater detail below.

Preamp Gain

The preamp gain of analog inputs 1 – 4 is adjusted with the rotary control. The preamp channel to be adjusted is set with the Channel Select (press) function. The input to be adjusted (Mic, Line, or Hi-Z) is determined by the state of the channel's Mic/Line input switch (#6) or Hi-Z input (if connected).

Rotating the knob clockwise increases the preamp gain for the selected channel. The available gain range for the preamp channels is 10 dB to 65 dB for the Mic, Line, and Hi-Z inputs.

More than one full revolution of the knob is needed to move through the available range. This feature increases the control resolution for more precise preamp gain adjustments.

Tip: To adjust signal levels for inputs 5 – 18, use the output level controls of devices connected to those inputs.

Line Input Gain Bypass

By default, line inputs 1 – 4 are routed through the channel's preamp so that the line input level can be adjusted with the Gain knob. However, line inputs 1 – 4 can be individually set to completely bypass the channel's preamp circuitry and instead be routed directly to the channel's A/D converter at a fixed reference level.

This feature is set with the LINE INPUT GAIN menus in the Hardware panel within the Console Settings window. See the [Apollo Software Manual](#) for details.

***Tip:** This feature routes the preamp channel's line input signal directly into the A/D converter for the purest path when additional gain is not needed (for example, when connecting external mic preamps to preamp channel line inputs).*

When the channel's LINE INPUT GAIN menu is set to BYPASS in Console Settings and the input mode is set to LINE:

- The Preamp Gain Indicator ring (#5) for the channel is solid green.
- When the Preamp Gain knob (#4) is rotated, the ring flashes to indicate that no gain adjustment is occurring.
- If a Unison plug-in is in the channel's dedicated Unison insert in Console, the Unison plug-in is bypassed.

Channel Select

Pressing the PREAMP knob changes the currently selected preamp channel, which determines which input (1 – 4) is adjusted by the front panel preamp controls. A preamp channel is selected for adjustment when its Channel Select Indicator (#13) is illuminated.

Each time the knob is pressed, the selected preamp channel increments to the next preamp channel. If stereo linking is active, the stereo pairs are selected.

Gain Stage Mode

Using Gain Stage Mode, up to three gain parameters within Unison UAD plug-ins can be remotely controlled with the front panel PREAMP knob.

Gain Stage Mode is activated by pressing and holding the PREAMP knob for two seconds when a Unison plug-in is active in the channel's dedicated Unison insert within the Console application. When Gain Stage Mode is active, pressing and holding the knob for two seconds deactivates Gain Stage Mode.

Gain Stage Mode is active when the Channel Select Indicator (#13) for the currently selected channel is flashing. In this state, pressing the PREAMP knob cycles through the available gain parameters within the Unison plug-in so each gain stage in the plug-in can be adjusted with the front panel PREAMP knob. The gain stage being controlled is shown by the front panel Unison Indicators (#12).

***Note:** For complete details about Gain Stage Mode, see the Unison chapter within the [Apollo Software Manual](#).*

(5) Preamp Gain Level & State Indicator

Preamp Gain Level Indicator

The amount of preamp gain for the currently selected channel is indicated by the illuminated ring surrounding the PREAMP knob.

The ring indicates relative gain levels and is not calibrated to indicate any specific dB value. However, precise numerical dB gain values for the preamps are displayed within the Console application.

Note: *If the ring is at maximum and flashes when the PREAMP knob is rotated, the channel's LINE input is selected and LINE INPUT GAIN is set to BYPASS. See [Line Input Gain Bypass](#) for additional details.*

Preamp State Indicator

In addition to the channel's relative preamp gain, the ring around the knob also indicates the current state of the preamp channel:

Unlit – The preamp gain is set to its minimum value (rotate the PREAMP knob clockwise increase gain).

Green (variable) – The preamp is in default operating mode with variable gain.

Green (fixed at maximum) – LINE is selected for the channel (#6) and LINE INPUT GAIN is set to BYPASS in the Hardware panel within the Console Settings window.

Orange – A UAD Unison plug-in is active in Console's dedicated Unison insert for the channel, and the PREAMP knob adjusts the first gain parameter in the Unison plug-in.

Amber (Channel Select Indicator flashing) – A UAD Unison plug-in is active in Console's dedicated Unison insert for the channel, the channel is in Gain Stage Mode, and the PREAMP knob adjusts the second gain parameter in the Unison plug-in (if available).

Green (channel select indicator flashing) – A UAD Unison plug-in is active in Console's dedicated Unison insert for the channel, the channel is in Gain Stage Mode, and the PREAMP knob adjusts the clean gain parameter in the Unison plug-in.

Note: *See the Unison chapter within the [Apollo Software Manual](#) for complete details about Unison operation and Gain Stage Mode.*

(6 – 11) Preamp Options

This set of six switches control the preamp options for input channels 1 – 4. Press the switches to toggle the setting. The current state of each preamp option is indicated by the LED within each switch. Each switch function is detailed below.

(6) Input (Mic/Line)

This switch determines which rear panel input jack, either Mic (XLR) or Line ($\frac{1}{4}$ "), is active for the channel. The switch has no effect if the channel's Hi-Z input is connected (the Hi-Z input must be disconnected to use the Mic/Line inputs).

Tip: Line inputs 1 – 4 can be set to bypass the preamp circuitry. See [Line Input Gain Bypass](#) for additional details.

(7) Low Cut Filter

When enabled, the channel's input signal passes through a low cut (high pass) filter. This 2nd-order coincident-pole filter has a cutoff frequency of 75 Hz with a slope of 12 dB per octave.

The low cut filter affects the Mic, Line, and Hi-Z inputs. Low Cut is typically used to eliminate rumble and other unwanted low frequencies from the input signal.

(8) Phantom Power (+48V)

When enabled, 48 volts of phantom power is supplied at the channel's rear panel XLR input. Most modern condenser microphones require 48V phantom power to operate. This option can only be activated when the Mic/Line input switch (#6) is set to Mic.

Caution: To avoid potential equipment damage, disable +48V phantom power on the channel before connecting or disconnecting its XLR input.

Depending on the current configuration of the hardware and software, there may be a delay when changing the +48V state to minimize the clicks/pops that are inherent when engaging phantom power. The +48V switch LED will blink rapidly during any delay.

(9) Pad

When enabled, the channel's XLR input signal level is attenuated by 20 dB. Pad does not effect the Line or Hi-Z inputs.

Pad can be used to reduce signal levels when overload distortion is present at low preamp gain levels, such as when particularly sensitive microphones are used on loud instruments, and/or if the A/D converter is clipping.

(10) Polarity

When enabled, the polarity (aka phase) of the input channel's signal is inverted. Polarity affects the Mic, Line, and Hi-Z inputs.

Tip: Polarity inversion can help reduce phase cancellations when more than one microphone is used to record a single source.

(11) Stereo Link

This switch links the preamp controls of adjacent preamp channels together (1+2 or 3+4) to create stereo input pairs. When channels are linked as a stereo pair, any preamp control adjustments will affect both channels of the stereo signal identically.

Note: Only the same type of inputs can be linked (Mic/Mic or Line/Line). The Hi-Z inputs cannot be linked.

(12) INPUT Indicators

These indicators (MIC, LINE, HI-Z, Unison 1/2/3) display which hardware input is currently active for the channel, and whether or not Unison technology is active on the input.

To select MIC or LINE, use the INPUT switch (#6). To select Hi-Z, plug a ¼" mono TS cable into the Hi-Z input. To activate Unison, place a Unison UAD plug-in into the input's dedicated Unison insert in the Console application.

LINE indicator color

The color of the LINE indicator changes to reflect the state of the LINE INPUT GAIN setting, which is configured in the Hardware panel within the Console Settings window.

White – LINE INPUT GAIN is ON. The line input is routed through the preamp so the input gain can be adjusted.

Green – LINE INPUT GAIN is OFF. The preamp circuitry is bypassed and the line input is fixed at a reference level of +4 dBu. Note that Unison cannot be active on a channel when its LINE INPUT GAIN is OFF.

Unison Input Indicators



The U1 indicator is lit when a Unison UAD plug-in is active on the currently selected preamp channel. Unison technology is activated by placing a Unison UAD plug-in into the dedicated Unison insert for the input channel in the Console application.

By default, the U1 indicator is lit when the Unison plug-in is active. When Unison's Gain Stage Mode is active, the three Unison indicators (U1, U2, U3) show which Unison plug-in gain parameter can be remotely controlled with the front panel PREAMP knob.

The U2 and U3 indicators illuminate only when the preamp channel is in Unison Gain Stage Mode. In this state, different Unison plug-in gain stage parameters are selected for adjustment by pressing the PREAMP knob.

Note: See the Unison chapter within the [Apollo Software Manual](#) for complete details about Unison operation and Gain Stage Mode.

(13) Channel 1 – 4 Select Indicators

The currently selected preamp channel is indicated by the illuminated numbers above level meters 1 – 4. When a preamp channel (or channels, when stereo linked) is selected, its channel number is illuminated. The currently selected channel increments when the PREAMP knob (#4) is pressed.

(14) Channel Level Meters

The 10-segment LED channel meters display the input or output signal peak levels for analog channels 1 – 8. Input or output metering is selected with the METER switch (#20). The input/output state is shown by the METER indicators (#17).

The dB values of the meter LEDs are indicated between the meters for channels 4 and 5. When digital clipping occurs in input (when 0 dBFS is exceeded), the red “C” (clip) LED illuminates.

Input Channel Meters

When set to INPUT, the channel meters display the signal peak input levels for analog channels 1 – 8 at the input to the A/D converters.

Avoid digital clipping at the channel’s A/D converter by reducing the output level of the device connected to the channel’s input, and/or in the case of channels 1 – 4, by reducing the preamp gain and/or engaging the Pad (#9) and readjusting gain as needed.

Output Channel Meters

When set to OUTPUT, the channel meters display the signal peak output levels for analog channels 1 – 8 at the output of the D/A converters.

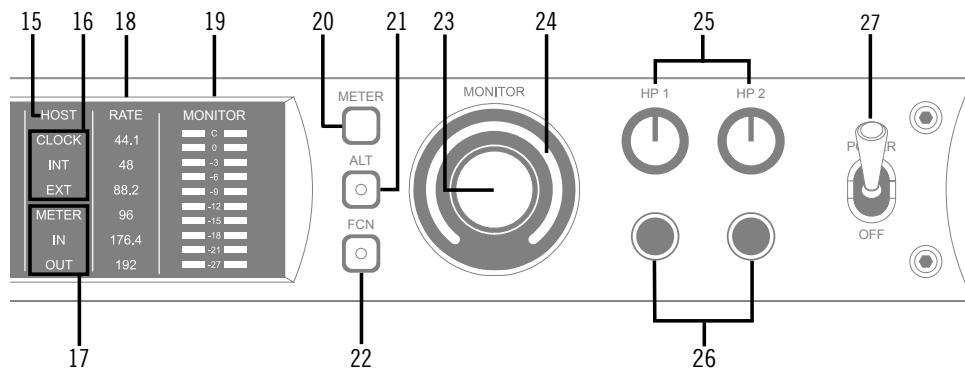

Apollo x8 front panel (right portion)

(15) HOST Indicator

The HOST indicator displays the status of the Thunderbolt connection to the host computer system. The possible states are:

Lit – The unit is communicating with the host computer and operating normally.

Unlit – The unit is starting up or it is not recognized by the host computer. Verify software installation and Thunderbolt connections.

Red – System error. Please contact UA technical support if the issue persists.

(16) CLOCK Indicators

The clock source and status are displayed with these indicators. Either internal (INT) or external (EXT) is displayed. The clock source is set within the Console application; see the Apollo Software Manual for details.

Internal Clock

When set to internal clock, the INT indicator is illuminated white.

External Clock

Apollo x8 can use an external digital clock source from the Word Clock, S/PDIF, or ADAT inputs. The EXT indicator has two possible states:

White – When set to external clock and a valid clock signal is detected at the specified port, the EXT indicator is illuminated white and Apollo x8 is synchronized to the external clock source.

Red – When set to external clock and a valid clock signal is NOT detected at the specified port, the EXT indicator is illuminated red and the internal clock remains active instead. In this situation, if/when the specified external clock becomes available, Apollo x8 switches back to the external clock, and the EXT indicator is illuminated and white.

Important: When set to use any external clock source, Apollo x8's sample rate must be manually set to match the sample rate of the external clock.

(17) METER Indicators

These indicators show the current state of the Channel Level Meters (#14). The current state is changed with the METER switch (#20).

IN – When IN is illuminated, the channel meters display analog input signal levels.

OUT – When OUT is illuminated, the channel meters display analog output signals levels.

(18) Sample Rate Indicators

These indicators display the current sample rate setting for A/D and D/A conversion. The sample rate is set within the Console application or the host DAW; see the Apollo Software Manual for details.

(19) Monitor Output Level Meters

The 10-segment LED meters display the signal peak output levels of the rear panel Left & Right Monitor outputs at the output of the D/A converters. These meters are before the Monitor Level control (pre-fader) and reflect the D/A converter levels regardless of the current Monitor Level and Headphone Level knob settings.

The dB values of the monitor meter LEDs are indicated between the left and right channel meters. When digital clipping occurs, the red “C” (clip) LED illuminates.

If the monitor output level clips, reduce the monitor output level within the DAW and/or reduce the output level of individual channels feeding the monitor output bus within the Console application.

(20) Meter Switch

This switch determines whether the Channel Level Meters (#14) are displaying input levels or output signal levels. Pressing the switch toggles the state of the meters and the Meter Indicators (#17).

(21) Monitor ALT Switch

When ALT monitoring is configured in the Hardware panel within the Console Settings window (when ALT COUNT is set to a non-zero value), this switch toggles between the main monitor outputs and the ALT 1 outputs (line outputs 1 & 2).

When the ALT switch is engaged:

- The monitor signals are routed to outputs 1 & 2 instead of the main monitor outputs.
- The orange LED within the switch is illuminated.
- The Monitor Level Indicator (#24) is orange instead of green.

For complete details about how to configure and use the ALT monitoring features, refer to the [Apollo Software Manual](#).

***Tip:** ALT 2 outputs (line outputs 3 & 4) can be selected with the FCN switch (#22) when configured in Console Settings, or in the MONITOR column within the Console application.*

(22) Monitor Function Switch (FCN)

This is an assignable switch that can be configured to control one of three monitoring functions. The function of the switch is configured with the FCN SWITCH ASSIGN menu in the Hardware panel within the Console Settings window. See the [Apollo Software Manual](#) for details.

The amber LED within the switch flashes when the monitoring function is active. The function is toggled with the switch is pressed again. The available functions are:

ALT 2 – Selects the ALT 2 monitor speakers. The monitor signals are routed to outputs 3 & 4 instead of the main monitor outputs, and the Monitor Level Indicator ring (#24) is amber instead of green when ALT 2 is active.

MONO – Sums the left and right channels of the stereo monitor mix into a monophonic signal. The Monitor Level Indicator ring (#24) flashes when MONO is active.

DIM – Attenuates the signal level at the monitor outputs by the dB amount set in the CONTROL ROOM strip within the Console application. The Monitor Level Indicator ring (#24) flashes when DIM is active.

TALKBACK – Activates the talkback mic and the DIM function. Talkback is active when the button is lit. Press and release the button quickly to latch talkback ON. To momentarily activate the function and deactivate when the button is released, press for longer than 0.5 seconds. The Monitor Level Indicator ring (#24) flashes when talkback is active.

Note: *When more than one Apollo interface is connected in a multi-unit configuration, the FCN switch is operable on the designated monitor unit only.*

(23) Monitor Level & Mute Knob

This rotary encoder serves two functions. Rotating the knob adjusts the monitor output level, and pressing the knob mutes the monitor outputs.

Monitor Level

Rotating the knob clockwise increases the signal level at the Left & Right Monitor Outputs on the rear panel. If ALT monitor outputs are configured and active, this knob controls the signal level at the ALT monitoring line outputs.

Monitor Mute

Pressing the Monitor knob toggles the mute state of the signals at the Left & Right Monitor Outputs on the rear panel. If ALT monitoring is configured in the Hardware panel within the Console Settings window (when ALT COUNT is a non-zero value), the ALT monitor outputs are also muted by this control.

When the monitor outs are muted, the Monitor Level Indicator ring (#24) is red.

Note: Monitor Mute does not mute the headphone outputs.

(24) Monitor Level & Monitor State Indicator

Tip: The Monitor Level and Monitor State indications are reflected in the Monitor column within the Console application.

Monitor Output Level Indicator

The relative signal level at the rear panel monitor outputs (and ALT monitor outputs, if configured) is indicated by the illuminated ring surrounding the Monitor Level knob.

This indicator is after the Monitor Level control (post fader). The ring indicates relative gain levels and is not calibrated to indicate any specific dB value.

Tip: Precise numerical dB gain values for the Monitor Level Knob are displayed within the Console application.

Monitor State Indicator

The color of the indicator ring indicates the current state of the monitor outputs:

Green – The main monitor outputs are active with variable level control.

Red – The main monitor outputs (and ALT monitor outputs, if configured) are muted.

Orange – The ALT 1 monitor outputs are active.

Amber – The FCN switch is active and assigned ALT 2.

Flashing – The monitor DIM, MONO, and/or TALKBACK functions are active.

(25) Headphone Level Knobs 1 & 2

These knobs control the volume of Headphone Outputs 1 & 2 on the front panel. Each headphone output has its own volume control.

(26) Headphone Outputs 1 & 2

These ¼" stereo TRS phone jacks are for stereo headphones. Headphone outputs 1 & 2 are individually addressable.

By default, both headphone outputs mirror the monitor outputs. When mirroring the monitor outputs, the headphone outputs are unaffected by Monitor Mute (#23), to facilitate recording/tracking with headphones while the monitor speakers are muted.

Unique mixes can be created for each headphone output using the CUE functions within Console or by assigning mix buses from a DAW to the headphone outputs via the device drivers.

(27) Power Switch

This switch applies power to Apollo x8. When the unit is powered on, the Universal Audio logo (#1) is illuminated. The external power supply must be properly connected for this switch to function.

Rear Panel

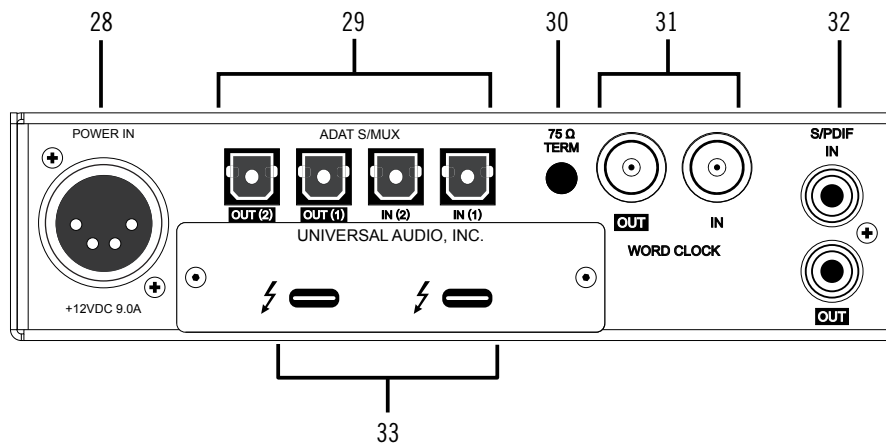

Apollo x8 rear panel (digital portion)

(28) Power Input

The included external power supply connects to this 4-pin locking XLR jack. Apollo x8 requires 12 volts DC power and draws a maximum of 72 watts (30 watts typical).

To eliminate risk of circuit damage, connect only the factory-supplied power supply. Use the Power switch on the front panel to power the unit on and off.

Important: Do not disconnect the power supply while Apollo x8 is in use, and confirm the Power switch is in the “off” position before connecting or disconnecting the power supply.

Digital I/O

(29) ADAT S/MUX Optical Ports

These TOSLINK ports use the ADAT Lightpipe Optical Interface protocol for interconnecting with other audio hardware devices in the digital domain. Two ADAT inputs and two ADAT outputs are provided, routing a total of eight channels of digital audio. The channels routed by these ports depend on the current system sample rate.

At sample rates of 44.1 kHz and 48 kHz, the original ADAT protocol is used, and eight audio channels are routed on one ADAT port. At higher sample rates, industry standard S/MUX is used to maintain high-resolution transfers.

Important: To utilize all eight channels with the optical ports at sample rates of 88.2 kHz and above, ADAT ports 1 & 2 must both be connected to the other device, and the other device must also support the ADAT S/MUX protocol.

The following behaviors apply to the ADAT ports:

- At sample rates of 44.1 kHz and 48 kHz, port 1 supports eight channels of I/O. Output 2 mirrors output 1, and input 2 is disabled.
- At sample rates of 88.2 kHz and 96 kHz, up to four channels of audio are routed per port (eight channels total, when both ports are used).
- At sample rates of 176.4 kHz and 192 kHz, up to two channels of audio are routed per port (four channels total, when both ports are used). Only four ADAT channels are supported at 176.4 kHz and 192 kHz.

The ADAT port channel assignments described above are summarized in this table:

ADAT PORT CHANNEL ROUTING				
Sample Rate (kHz)	Input Port 1	Input Port 2	Output Port 1	Output Port 2
44.1 & 48	1 – 8	Disabled	1 – 8	1 – 8 (mirror of port 1)
88.2 & 96	1 – 4	5 – 8	1 – 4	5 – 8
176.2 & 192	1 – 2	3 – 4	1 – 2	3 – 4

Note: The ADAT ports use TOSLINK JIS F05 optical connectors. Some devices use this type of connector for optical S/PDIF connections. However, Apollo x8's ADAT ports do not support the S/PDIF protocol (use the coaxial S/PDIF ports instead).

(30) 75 Ohm Word Clock Termination Switch

This switch provides internal 75-ohm word clock input signal termination when required. Word clock termination is active when the switch is engaged (depressed).

Apollo x8's termination switch should only be engaged when Apollo x8 is set to sync to external word clock and it is the last device at the receiving end of a word clock cable. For example, if Apollo x8 is the last "slave" unit at the end of a clock chain (when Apollo x8's word clock OUT port is not used), termination should be active.

(31) Word Clock I/O

Word Clock In

Apollo x8's internal clock can be synchronized (slaved) to an external master word clock. This is accomplished by setting Apollo x8's clock source to Word Clock within the Console application, connecting the external word clock's BNC connector to Apollo x8's word clock input, and setting the external device to transmit word clock. If Apollo x8 is the last device in the clock chain, the Termination switch (#30) should be engaged.

Important: *Apollo x8's sample rate must be manually set to match the incoming clock's sample rate.*

Note: *Apollo x8 can be synchronized to an external "1x" clock signal only. Superclock, overclocking, and subclocking are not supported.*

Word Clock Out

This BNC connector transmits a standard (1x) word clock when Apollo x8 is set to use its internal clock. The clock rate sent by this port matches the current system sample rate, as specified within the Console application.

When Apollo x8 is set to use external word clock as its clock, Apollo x8 is a word clock slave. If the incoming external word clock is within $\pm 4\%$ of a supported sample rate (44.1 kHz, 48 kHz, 88.2 kHz, 96 kHz, 176.4 kHz, 192 kHz), Word Clock Out will mirror Word Clock In with a slight phase delay (about 40ns).

Because Apollo x8's word clock output is not a true mirror of the word clock input, word clock out should not be used to daisy chain the word clock if Apollo x8 is in the middle of the word clock chain. The correct method to connect Apollo x8 in the middle of a word clock chain is to use a T-connector at Apollo x8's word clock input and leave Apollo x8's word clock output unconnected. In this configuration, the Termination switch should not be engaged.

(32) S/PDIF Ports

The S/PDIF ports provide two channels of digital I/O with resolutions up to 24-bit at 192 kHz via female phono (RCA) connectors. For optimum results, use only high-quality 75-ohm cables specifically designed for S/PDIF digital audio.

SR Convert

Sample rate conversion can be performed on the S/PDIF input; this setting is enabled within the S/PDIF channel's input strip in the Console application. When the sample rate of the incoming S/PDIF signal does not match the sample rate specified in the Console application, the S/PDIF signal is converted to match Apollo x8's sample rate. If Apollo x8 is set to use S/PDIF as the master clock source, sample rate conversion is inactive.

Mirror Monitor Outputs

The S/PDIF output can be configured to mirror the Monitor Outputs (#35), for routing the stereo monitor signal to the stereo S/PDIF input of other devices. This feature is set with the DIGITAL MIRROR menu in the Hardware panel within the Console Settings window.

(33) Thunderbolt 3 Ports

Apollo x8 has two Thunderbolt 3 ports. One port is used to connect Apollo x8 to a Thunderbolt 3 port on the host computer. Thunderbolt 3 peripheral devices may be serially connected (daisy-chained) to the second Thunderbolt 3 port.

When Apollo x8 is properly communicating with the host computer via Thunderbolt, the HOST indicator (#15) illuminates.

***Note:** Apollo x8 can be used with Thunderbolt 1 and Thunderbolt 2 ports on Apple Mac computers via the Apple Thunderbolt 3 to Thunderbolt 2 Adapter. Connections to Thunderbolt 1 or Thunderbolt 2 ports on Windows PCs are not supported.*

Thunderbolt Bus Power

Per the Thunderbolt specification, bus power is supplied to downstream (daisy-chained) Thunderbolt peripheral devices. Apollo x8 must be powered on for the daisy-chained peripheral to receive Thunderbolt bus power.

Analog I/O

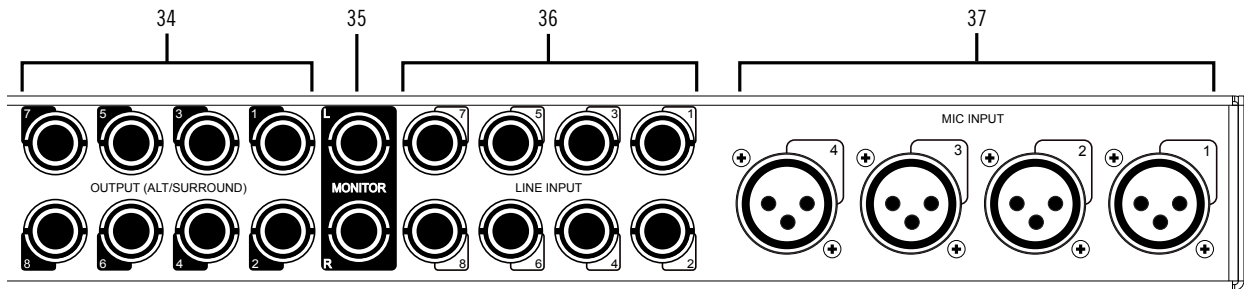

Apollo x8 rear panel (analog portion)

(34) Line Outputs 1 – 8

The individually addressable line-level analog outputs use balanced ¼” TRS phone jacks. Unbalanced ¼” TS cables can also be used. The Line Outputs are DC coupled.

Line Output Headroom

By default, the operating level of the line outputs is +20 dBu. The line outputs and inputs can be globally configured to operate at +24 dBu signal levels with the HEADROOM menu in the Settings>Hardware panel within the Console application.

+24 dBu operation is typically used for interfacing with professional audio equipment such as large format consoles, analog tape machines, and similar devices that require higher signal levels. For additional details about +24 dBu operation, see the [Apollo Software Manual](#).

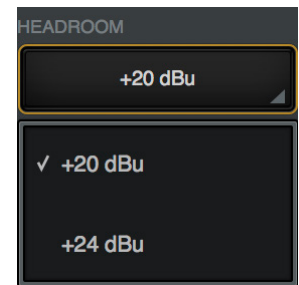

Headroom menu within Console Settings

Line Output Reference Levels

The Line Outputs can be configured in adjacent pairs to use either –10 dBV or +4 dBu reference levels. This function is configured in the Hardware panel within the Console Settings window. See the [Apollo Software Manual](#) for details.

ALT Outputs 1 – 4

Apollo x8 features ALT (alternate) monitoring capabilities. ALT monitoring can be used to control up to two alternate pairs of monitor speakers.

When ALT monitoring is enabled, the output level and muting of line outputs 1 & 2 (ALT 1) and 3 & 4 (ALT 2) are controlled by the Monitor Level & Mute knob (#23). ALT monitoring is enabled in the Hardware panel within the Console Settings window by increasing the ALT COUNT setting to a non-zero value.

(35) Left & Right Monitor Outputs

These balanced ¼” TRS phone jacks are line-level analog outputs typically used for connection to a stereo loudspeaker monitoring system. Unbalanced ¼” TS cables can also be used. The Monitor Outputs are DC coupled.

The signal levels and muting at these outputs are controlled with the Monitor Level & Mute knob (#23).

The Monitor Outputs can be configured to use an operating level of +4 dBu (default value) or -10 dBV. This option is set in the Hardware panel within the Console Settings window. See the [Apollo Software Manual](#) for details.

The Monitor Outputs are completely independent and separately addressable from the eight Line Outputs (except when ALT monitoring is configured). By default, the “1–2” or “L–R” or “Main” outputs from a DAW are routed to these outputs (these labels vary within each particular DAW).

***Tip:** The S/PDIF output (#32) can be configured to mirror the Monitor Outputs, for routing the stereo monitor signal to the stereo S/PDIF input of other devices. This feature is set with the DIGITAL MIRROR menu in the Hardware panel within the Console Settings window.*

(36) Line Inputs 1 – 8

***Important:** To use a ¼” line input, the channel’s INPUT indicator (#12) must be set to LINE with the INPUT switch (#6) or the channel’s MIC/LINE switch within the Console application.*

The individually addressable line-level analog inputs use balanced ¼” TRS phone jacks. Unbalanced ¼” TS cables can also be used. The Line Outputs are DC coupled.

***Note:** The Hi-Z inputs override the Line Inputs on channels 1 & 2.*

Line Input Headroom

By default, the operating level of the line inputs is +20 dBu. The line inputs and outputs can be globally configured to operate at +24 dBu signal levels with the HEADROOM menu in the Settings>Hardware panel within the Console application.

+24 dBu operation is typically used for interfacing with professional audio equipment such as large format consoles, analog tape machines, and similar devices that require higher signal levels. For additional details about +24 dBu operation, see the [Apollo Software Manual](#).

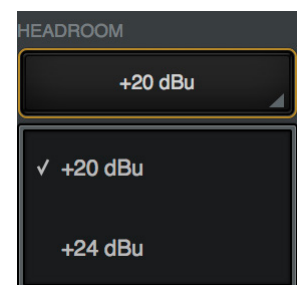

Headroom menu within Console Settings

Line Input Reference Levels

Line Inputs 5 – 8 can be individually configured to use –10 dBV or +4 dBu reference levels. This option is set in the channel input strips within the Console application. See the [Apollo Software Manual](#) for details.

Variable Gain

Line inputs 1 – 4 can be routed into the channel's preamplifier for variable gain adjustments, or the preamp circuitry can be completely bypassed for the purest path directly into the A/D converter. The BYPASS option is set with the LINE INPUT GAIN menu in the Hardware panel within the Console Settings window. By default, line inputs 1 – 4 are routed into the preamp.

When the preamps are bypassed, line inputs 1 – 4 operate at a fixed reference level of +4 dBu. When routed into the preamps, gain for line inputs 1 – 4 is continuously variable with up to 65 dB of available gain.

Note: For related information, see [Line Input Gain Bypass](#).

(37) Microphone Inputs 1 – 4

Important: To use an XLR mic input, the channel's INPUT indicator (#12) must be set to MIC with the INPUT switch (#6) or the channel's MIC/LINE switch within the Console application.

The balanced Microphone inputs use locking XLR jacks. Pin 2 is wired positive (hot). Inputs 1 – 4 are switched between MIC and LINE using the front panel controls.

Note: The Hi-Z inputs override the mic inputs on channels 1 & 2.

The XLR mic inputs are always routed into the channel's microphone preamplifier. The gain is controlled by the PREAMP knob (#4) when the channel is selected, or from within the Console application. The mic preamps provide up to 65 dB of gain.

+48V phantom power is individually available for each mic input via the front panel switch (#8, when the channel is selected), or from within the Console application.

Caution: To avoid potential equipment damage, disable +48V phantom power on the channel before connecting or disconnecting its XLR input.

Interconnections

Installation Notes

- Apollo X may get hot during normal operation if it doesn't receive adequate airflow circulation around its chassis vents. For optimum results when mounting Apollo X in a rack, leaving at least one empty rack space above the unit to allow adequate airflow for cooling is strongly recommended.
- If Apollo X is installed near other heat generating equipment, external cooling (such as a fan) may be needed to keep the ambient temperature below 104°F (40°C).
- As with any sound system, the following steps are recommended to avoid audio spikes in your speakers and headphones:
 1. Apply power to the speakers last, after all other devices (including Apollo x8) are powered on.
 2. Turn off the speakers first, before all other devices (including Apollo x8) are powered off.
 3. Remove headphones from ears before powering Apollo x8 on or off.

Connection Notes

Thunderbolt

- Apollo X must be connected via a Thunderbolt 3 cable (not included) to computers that have Thunderbolt 3 ports.*
- Connect only one Thunderbolt 3 cable between Apollo X and the host computer. Thunderbolt is a bidirectional protocol.
- Apollo X cannot be bus powered via Thunderbolt. The included external power supply must be used.
- Thunderbolt bus power is supplied to downstream (daisy-chained) peripheral devices. Apollo X must be powered on for the daisy-chained peripheral to receive Thunderbolt bus power.

**Note: With Mac computers only, Apollo X can be connected to Thunderbolt 1 and Thunderbolt 2 computer ports via the Apple Thunderbolt 3 to Thunderbolt 2 adapter. Visit help.uaudio.com for details.*

Apollo Expanded

- When more I/O and/or DSP is needed, up to four Apollo interfaces and six UAD devices total can be cascaded together via Thunderbolt in a multiple-unit configuration. For complete details about multi-unit cascading, refer to the Apollo Thunderbolt Software Manual.

About Thunderbolt 3 Ports and Cables

Important: Although Thunderbolt 3 always uses USB-C connectors, not all USB-C ports are Thunderbolt 3 ports. Similarly, not all USB-C cables are Thunderbolt 3 cables. Always connect Apollo x8 to a Thunderbolt 3 port with a Thunderbolt 3 cable.

USB-C is not Thunderbolt 3

Thunderbolt 3 uses USB-C connections to transfer data and power. However, USB-C is simply a connector type; it doesn't determine the type of data used by the connector. For example, USB-C connections can be used for Thunderbolt 3, USB 3.1, and other data protocols, so USB-C connections are not always interchangeable.

Does your USB-C connector support Thunderbolt 3?



To determine if a USB-C port or cable connector supports Thunderbolt 3, look for the Thunderbolt icon. The Thunderbolt icon on a USB-C port or cable means the connector supports Thunderbolt 3. Alternately, confirm Thunderbolt 3 compatibility with the device and/or cable manufacturer.



Thunderbolt icon on USB-C cable (left) and USB-C port (right)

Typical Setup

The diagram below illustrates an Apollo x8 setup example that could be used for recording an ensemble. ALT monitors are connected for comparing different speakers.

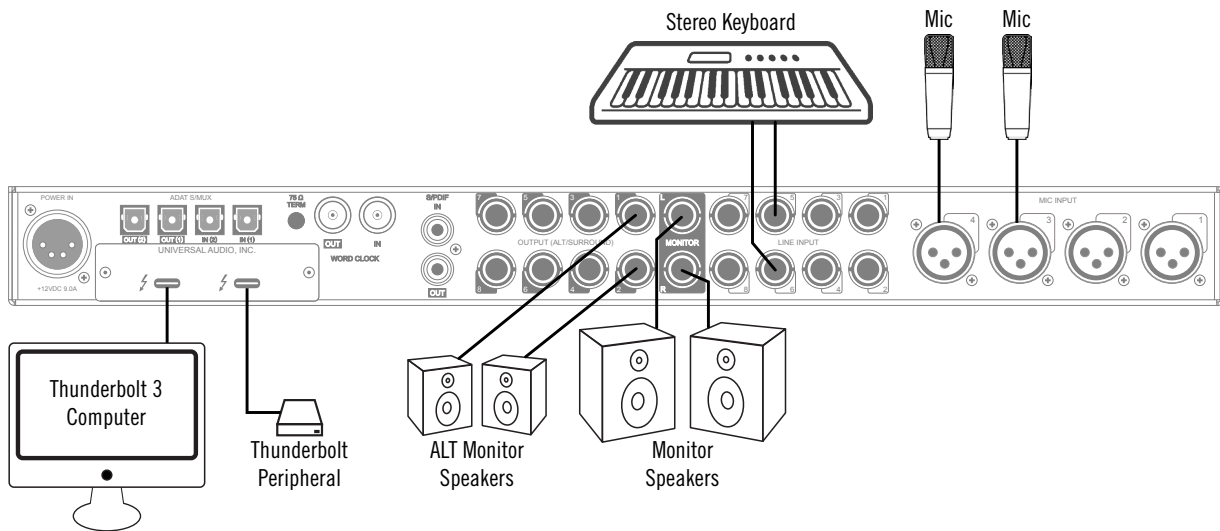
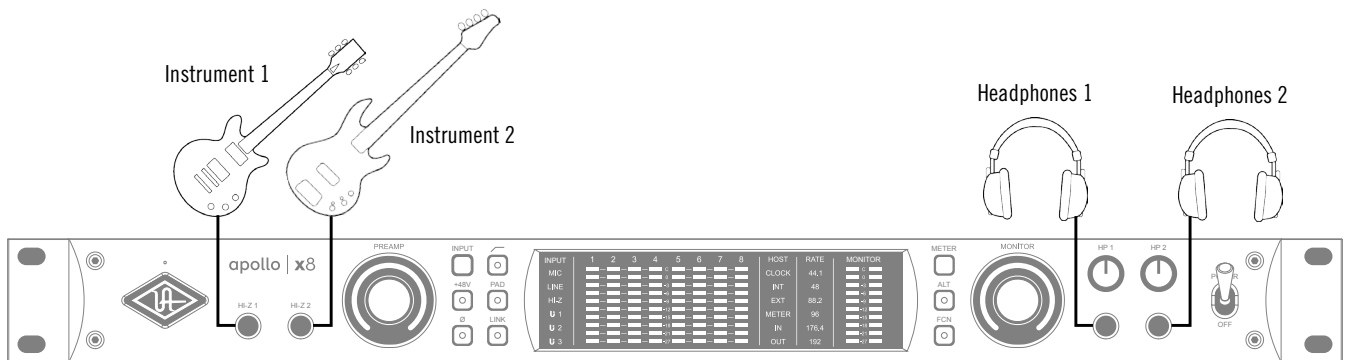

Typical Apollo x8 connections

Apollo Expanded: Multi-Unit Thunderbolt 3 Wiring

The diagram below illustrates an example of how to interconnect multiple Apollo units and the host computer via Thunderbolt 3.

Important: For complete details about system operation when multi-unit cascading, see the [Apollo Software Manual](#).

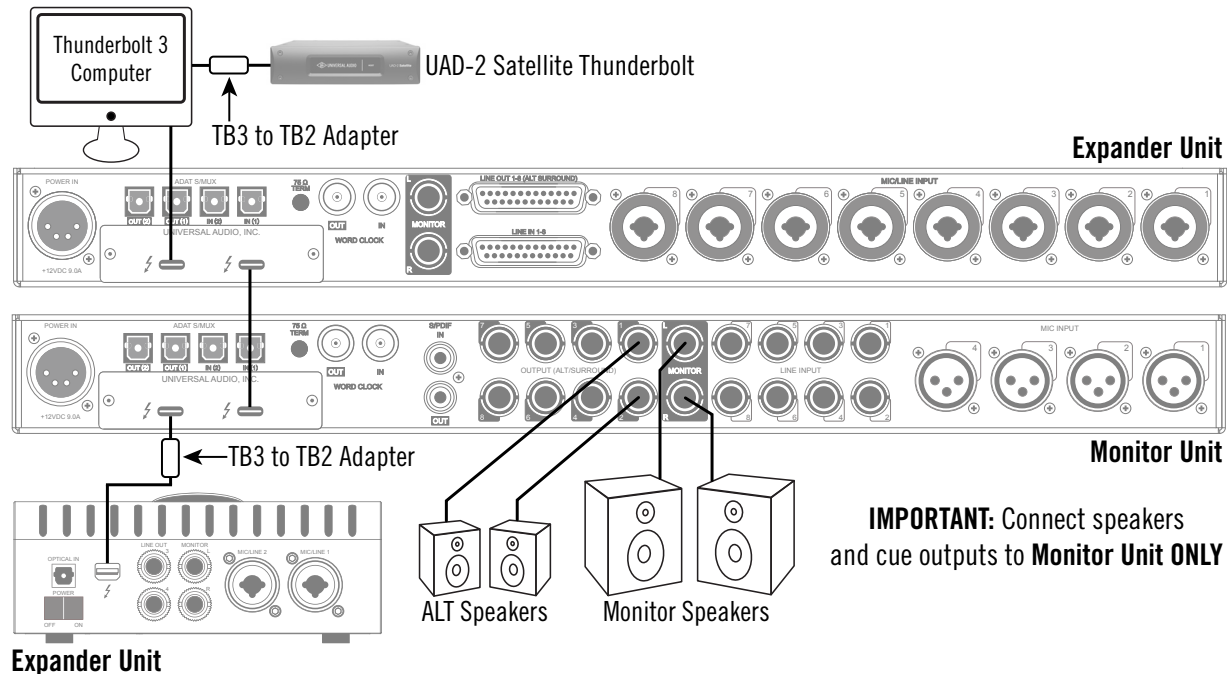

Connecting multiple Apollo X units via Thunderbolt 3

Apollo Expanded Wiring Notes

- Apollo X-series units with Thunderbolt 3 can be mixed with older Apollo units with Thunderbolt 2 by using compatible Thunderbolt 3 to Thunderbolt 2 adapters.
- Apollo device ordering and Thunderbolt ports used (second port on Apollo vs. second port on computer, placement within daisy chain, etc) is not important.
- In this example diagram, Apollo x8 is the monitor (master) unit designated in the Console Settings window. Connect speakers (including ALT speakers) and any cue outputs to the monitor unit only.
- Do not interconnect any Word Clock, FireWire, ADAT, or MADI ports between any Apollo units. All Apollo clocking is automatically managed via Thunderbolt.
- Up to four Apollo units and six UAD devices total can be combined within the same system.
- The computer and all Apollo/UAD units must be connected to the same Thunderbolt bus.

Note: On Mac systems only, Apollo x8 can be connected to Thunderbolt 1 and Thunderbolt 2 computers via the Apple Thunderbolt 3 to Thunderbolt 2 adapter. Visit help.uaudio.com for details.

Software Setup

Note: Items on this page are detailed in the [Apollo Software Manual](#).

System Requirements

All system requirements must be met for Apollo X to operate properly. Before proceeding with installation, see the system requirements in the Apollo Software Manual.

Software Installation

The software must be installed to use the hardware and UAD plug-ins. The UAD Powered Plug-Ins software installer contains the Apollo X software, drivers, and UAD plug-ins.

Registration and Authorization

Apollo X must be registered and authorized to unlock UAD plug-ins that are bundled with the product. To register and authorize Apollo x8, visit:

- www.uaudio.com/register

Note: For optimum results, connect and power on Apollo X before installing the software.

Latest Software

To obtain the latest UAD installer after initial registration, visit:

- www.uaudio.com/downloads

System Configuration

Complete details about setting up the Apollo X system, including how to integrate with a DAW and related information, are included in the Apollo Software Manual.

Console Application

The included Console application is the software interface for the Apollo X hardware. Console controls Apollo X and its digital mixing, monitoring, and Realtime UAD Processing features. Console is also used to configure Apollo X I/O settings such as sample rate, clock source, and reference levels.

For complete details about how to operate Console, refer to the Apollo Software Manual.

UA Support Videos

Informational videos are available to help you get started with Apollo X:

- help.uaudio.com

Specifications

All specifications are typical performance unless otherwise noted. Tested with the Audio Precision APx555 Audio Analyzer under the following conditions: 48 kHz internal sample rate, 24-bit sample depth, 20 kHz measurement bandwidth, +24 dBu headroom, balanced output, and internal clock.

SYSTEM	
<i>I/O Complement</i>	
Microphone Inputs	Four
High Impedance (Hi-Z) Instrument Inputs	Two
Analog Line Inputs	Eight
Analog Line Outputs (DC coupled)	Eight (ten including Monitor outputs)
Analog Monitor Outputs (DC coupled)	Two (one stereo pair)
Headphone Outputs	Two stereo
ADAT	Up to eight channels via dual I/O ports with S/MUX
S/PDIF	One stereo input, one stereo output
Thunderbolt 3 Ports	Two
Word Clock	One input, one output
<i>A/D – D/A Conversion</i>	
Simultaneous A/D conversion	Eight channels
Simultaneous D/A conversion	14 channels
Supported Sample Rates (kHz)	44.1, 48, 88.2, 96, 176.4, 192
Bit Depth Per Sample	24
Analog Round-Trip Latency	1.1 milliseconds @ 96 kHz sample rate
Analog Round-Trip Latency through four UAD legacy plug-ins (included) via Console software	1.1 milliseconds @ 96 kHz sample rate (no additional latency via Realtime UAD Processing)

(continued)

ANALOG I/O	
<i>Microphone Inputs 1 – 4</i>	
Frequency Response	20 Hz – 20 kHz, ± 0.05 dB
Dynamic Range	122 dB (A-weighted)
Total Harmonic Distortion + Noise Ratio (1 kHz @ 4.9 dBu)	-114 dB (0.00020%)
Maximum Input Level (PAD on)	26 dBu
Default Input Impedance	5.5k Ohms (variable via Unison plug-ins)
Gain Range	+10 dB to +65 dB
Pad Attenuation (switchable per input)	20 dB (variable via Unison plug-ins)
Phantom Power	+48V (switchable per mic input)
Connector Type	XLR Female, pin 2 positive
<i>Hi-Z Inputs 1 – 2</i>	
Frequency Response	20 Hz – 20 kHz, ± 0.04 dB
Dynamic Range	121 dB (A-weighted)
Total Harmonic Distortion + Noise Ratio (1 kHz @ 11.2 dBu)	-111 dB (0.00028%)
Maximum Input Level	12.4 dBu
Default Input Impedance	1M Ohms (variable via Unison plug-ins)
Gain Range	+10 dB to +65 dB
Connector Type	$\frac{1}{4}$ " Female TS Unbalanced
<i>Line Inputs 1 – 8</i>	
Frequency Response	20 Hz – 20 kHz, ± 0.05 dB
Dynamic Range	123 dB (A-weighted)
Total Harmonic Distortion + Noise Ratio (1 kHz @ 23 dBu)	-113 dB (0.00022%)
Maximum Input Level	24 dBu
Input Impedance	10k Ohms
Gain Range	+10 dB to +65 dB
Connector Type	$\frac{1}{4}$ " Female TRS Balanced
<i>Line Outputs 1 – 8</i>	
Frequency Response	20 Hz – 20 kHz, ± 0.07 dB
Dynamic Range	127 dB (A-weighted)
Total Harmonic Distortion + Noise Ratio (1 kHz @ -1 dBFS)	-119 dB (0.00011%)
Maximum Output Level	24 dBu
Output Impedance	100 Ohms
Connector Type	$\frac{1}{4}$ " Female TRS Balanced
<i>Monitor Outputs 1 – 2</i>	
Frequency Response	20 Hz – 20 kHz, ± 0.06 dB
Dynamic Range	129 dB (A-weighted)
Total Harmonic Distortion + Noise Ratio (1 kHz @ -1 dBFS)	-118 dB (0.00012%)
Maximum Output Level	24 dBu
Output Impedance	100 Ohms
Connector Type	$\frac{1}{4}$ " Female TRS Balanced
<i>Stereo Headphone Outputs 1 – 2</i>	
Frequency Response	20 Hz – 20 kHz, ± 0.05 dB
Dynamic Range	125 dB (A-weighted)
Total Harmonic Distortion + Noise Ratio (1 kHz @ -1 dBFS)	-102 dB (0.00080%)
Maximum Output Power (into 300 ohm load)	150 mW RMS
Connector Type	$\frac{1}{4}$ " Female TRS Stereo

(continued)

DIGITAL I/O	
<i>S/PDIF</i>	
Connector Type	Female Phono (RCA)
Format	IEC 958
Supported Sample Rates (kHz)	44.1, 48, 88.2, 96, 176.4, 192
<i>ADAT</i>	
Connector Type	Optical TOSLINK JIS F05
Format	ADAT Digital Lightpipe with S/MUX
Supported Sample Rates (kHz)	44.1, 48, 88.2, 96, 176.4, 192
Channel Assignments @ 44.1 kHz, 48 kHz	Port 1 = Channels 1 – 8, Port 2 = 1 – 8 (mirrored)
Channel Assignments @ 88.2 kHz, 96 kHz	Port 1 = Channels 1 – 4, Port 2 = Channels 5 – 8
Channel Assignments @ 176.4 kHz, 192 kHz	Port 1 = Channels 1 – 2, Port 2 = Channels 3 – 4
<i>Word Clock</i>	
Connector Type	BNC
Lock Range	±4% of any supported sample rate
Word Clock Input Termination	75 Ohms, switchable
<i>Synchronization Sources</i>	
Internal, Word Clock, ADAT, S/PDIF	

(continued)

ELECTRICAL	
Power Supply	External AC-to-DC Power Supply, Level VI compliant
AC Input Connector Type	IEC Male
AC Requirements	100V – 240V AC, 50 – 60 Hz
DC Connector Type	XLR 4-Pin Locking Male (Neutrik P/N NC4MDM3-H)
DC Requirements	12 VDC, 6A
Maximum Power Consumption	72W (30W typical)
ENVIRONMENTAL	
Ambient Temperature Range	32° to 104° F (0° to 40° C)
MECHANICAL	
<i>Dimensions</i>	
Width	19 in (48,26 cm)
Height (1U rack space)	1.75 in (4,45 cm)
Depth, Chassis Only	12.125 in (30,80 cm)
Depth, Including Knob & Jack Protrusions	13.5 in (34,29 cm)
Shipping Box (Width x Depth x Height)	23.5 in x 17 in x 7.5 in (59,69 cm x 43,18 cm x 19,05 cm)
<i>Weight</i>	
Shipping Weight (with box & accessories)	USA: 16.6 lbs (7.52 kg) EU & UK: 16.9 lbs (7.64 kg)
Weight (bare unit)	9 lbs (4.08 kg)
<i>Package Contents</i>	
Apollo x8 Audio Interface Unit	
External Power Supply	
AC Power Cable (IEC), Region Specific	
Set of (4) Rack-Mount Screws	
Getting Started URL Card	

Block Diagram

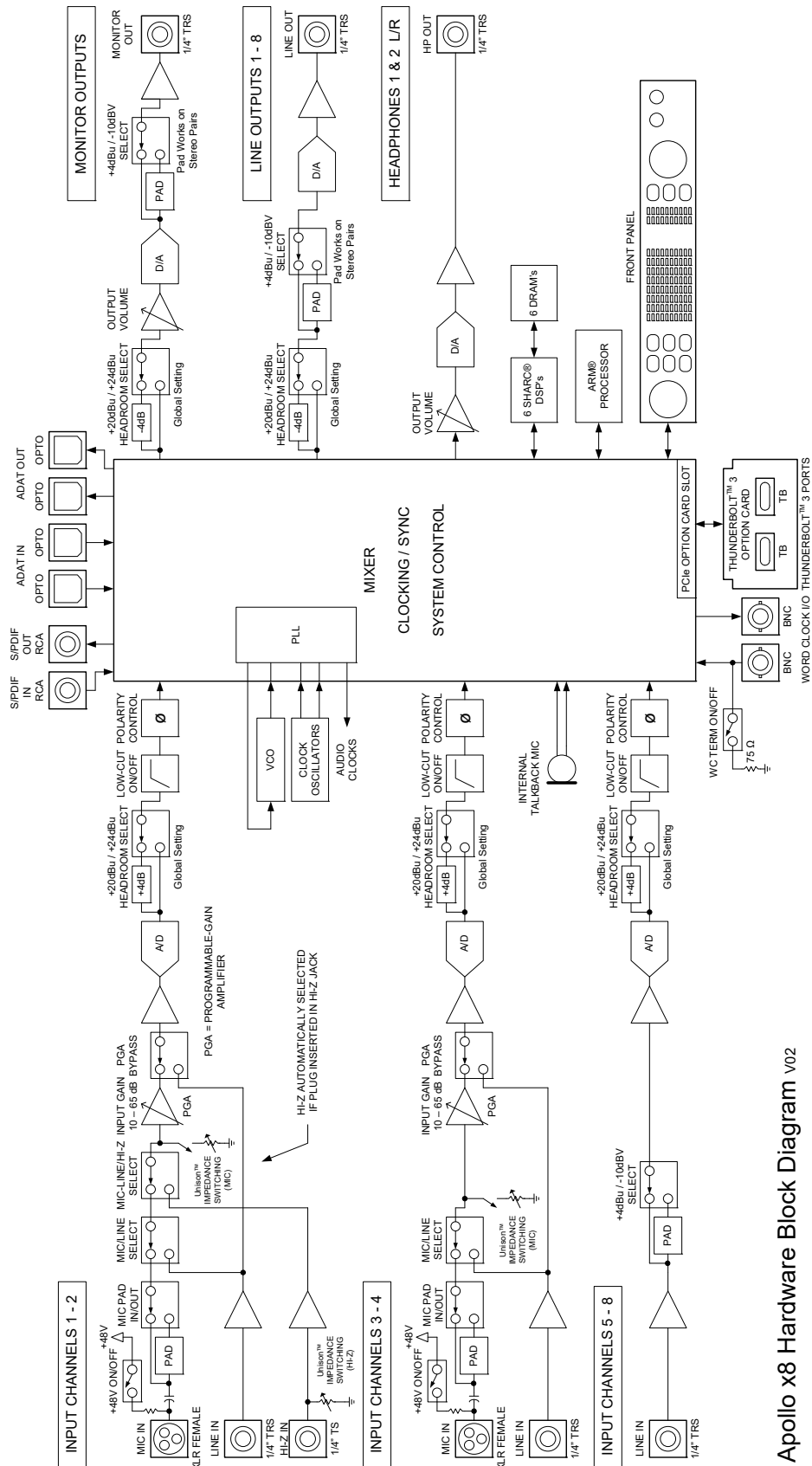

Apollo x8 Hardware Block Diagram v02

Troubleshooting

If Apollo x8 isn't behaving as expected, here are some common troubleshooting items to confirm. If you are still experiencing issues after performing these checks, contact [Technical Support](#).

SYMPTOM	ITEMS TO CHECK
Unit won't power on	<ul style="list-style-type: none"> • Confirm power supply connections at power supply input and back of unit • Confirm Power switch is in UP position • Confirm AC power is available at wall socket by plugging in a different device
No monitor output	<ul style="list-style-type: none"> • Confirm connections, power, and volume of monitoring system • Confirm monitor knob is turned up • Confirm monitor outputs are not muted (push monitor knob) • Confirm monitor LEDs are active (check signal flows)
Can't hear preamp channels	<ul style="list-style-type: none"> • Confirm preamp gain is turned up for the channel(s) • Confirm MUTE is not engaged in Console input channel strip
Can't hear mic or line input(s)	<ul style="list-style-type: none"> • Confirm mic/line switch setting is correct for the channel • Confirm nothing is plugged into the channel's Hi-Z input • Confirm MUTE is not engaged in Console input channel strip
Can't hear Hi-Z input(s)	<ul style="list-style-type: none"> • Confirm volume on connected device is turned up • Confirm Hi-Z input cable is 1/4" TS only (not TRS) • Confirm MUTE is not engaged in Console input channel strip
Can't hear mic input(s)	<ul style="list-style-type: none"> • Confirm +48V phantom power is enabled (if required by microphone)
Preamp controls have no effect on channel	<ul style="list-style-type: none"> • Confirm desired channel is selected for control (push PREAMP knob to select) • Preamp controls are not available for non-preamp channels
Can only adjust preamp input channels	<ul style="list-style-type: none"> • Signal levels for all non-preamp inputs, including digital inputs, are adjusted at the device connected to those inputs
Audio glitches and/or dropouts during playback	<ul style="list-style-type: none"> • Increase audio buffer size setting • Confirm clocking setups; check cable connections and confirm all device clocks are synchronized to one master clock device
Undesirable echo/phasing	<ul style="list-style-type: none"> • Confirm only one input monitoring system is enabled (Console or DAW – not both)
HOST indicator is unlit or red	<ul style="list-style-type: none"> • Confirm Thunderbolt 3 connections • Confirm Apollo X software is installed • Power Apollo X off then on, and restart computer • Reinstall Apollo X software • Try a different Thunderbolt 3 cable
Static and/or white noise is heard when nothing is plugged in	<ul style="list-style-type: none"> • Mute or lower preamp gain to minimum on all unused preamp channels (mic preamps can emit noise even when nothing is plugged in) • Some UAD plug-ins model the noise characteristics of the original equipment. Defeat the noise model in the UAD plug-in GUI, or mute the channel containing the plug-in to temporarily mute the noise
Various LEDs inside the unit are blinking	<ul style="list-style-type: none"> • This is normal operational behavior that can be safely ignored
Apollo X is behaving unexpectedly	<ul style="list-style-type: none"> • As a last resort, perform a hardware reset on the unit by following these steps: <ol style="list-style-type: none"> 1. Power off Apollo X 2. Press and hold the PREAMP, LOW CUT, and POLARITY controls 3. Power on Apollo X while continuing to hold all three controls 4. After all front panel LEDs flash rapidly (after several seconds), release the controls

Notices

Warranty

Universal Audio provides a limited warranty on all UA hardware products. To learn more, visit help.uaudio.com. The limited warranty gives you specific legal rights. You may also have other rights which vary by state or country.

Repair Service

If you are having trouble with Apollo X, first check all system setups, connections, and operating instructions. If that doesn't help, contact our technical support team.

To learn about repair service, or for technical support, visit help.uaudio.com.



Maintenance

- **CAUTION:** To reduce the risk of electric shock, do not open the unit.
- Apollo X does not contain a fuse or any other user-replaceable parts. The unit is internally calibrated at the factory. No internal user adjustments are available.

Important Safety Information



Before using this unit, be sure to carefully read the applicable items of these operating instructions and the safety suggestions. Afterwards, keep them handy for future reference. Take special care to follow the warnings indicated on the unit, as well as in the operating instructions.

- 1) Read these instructions.
- 2) Keep these instructions.
- 3) Heed all warnings.
- 4) Follow all instructions.
- 5) Do not use this apparatus near water.
- 6) Clean only with dry cloth.
- 7) Do not block any ventilation openings. Install in accordance with the manufacturer's instructions.
- 8) Do not install near any heat source such as radiators, heat registers, stoves, or other apparatus (including amplifiers) that produce heat.
- 9) Do not defeat the safety purpose of the polarized or grounding-type plug. A polarized plug has two blades with one wider than the other. A grounding type plug has two blades and a third grounding prong. The wide blade or the third prong are provided for your safety. If the provided plug does not fit into your outlet, consult an electrician for replacement of the obsolete outlet.
- 10) Protect the power cord from being walked on or pinched particularly at plugs, convenience receptacles, and the point where they exit from the apparatus.
- 11) Only use with attachments/accessories specified by the manufacturer.
- 12) Use only with the cart, stand, tripod, bracket, or table specified by the manufacturer, or sold with the apparatus. When a cart is used, use the caution when moving the cart/apparatus combination to avoid injury from tip-over.
- 13) Unplug this apparatus during lightning storms or when unused for long periods of time.
- 14) Refer all servicing to qualified service personnel. Servicing is required when the apparatus has been damaged in any way, such as power-supply cord or plug is damaged, liquid has been spilled or objects have fallen into the apparatus, the apparatus has been exposed to rain or moisture, does not operate normally, or has been dropped.

Description of symbols used



The lightning flash represented by the arrow symbol in an equilateral triangle is intended to alert users to the presence of high voltage within the unit that could cause an electrical shock hazard.



The exclamation mark in an equilateral triangle is intended to alert users to the existence of important instructions in the manual relating to the use and maintenance of the unit.

FCC Compliance

Federal Communications Commission United States Class A Manual Statements

Note: This equipment has been tested and found to comply with the limits for a Class A digital device pursuant to Part 15 of the FCC Rules. These limits are designed to provide reasonable protection against harmful interference when the equipment is operated in a commercial environment. This equipment generates, uses, and can radiate radio frequency energy and, if not installed and used in accordance with the instruction manual, may cause harmful interference to radio communications. Operation of this equipment in a residential area is likely to cause harmful interference to radio communications. Operation of this equipment in a residential area is likely to cause harmful interference in which case the user will be required to correct the interference at their own expense.

Any modifications to the unit, unless expressly approved by Universal Audio, could void the User's authority to operate the equipment.

- Canada: Innovation, Science and Economic Development Canada Interference Causing Equipment Standard ICES-003, Issue 6, dated January 2016 (class A)
- Japan: VCCI-CISOR 32:2016, "Technical Requirements" for multimedia equipment (class A)
- EN 55022:2010, "Information technology equipment – Radio disturbance characteristics – Limits and method of measurements" (Class A)
- CISPR 22:2008, "Information technology equipment – Radio disturbance characteristics – Limits and method of measurement" (Class A)
- EN 55032:2010, "Electromagnetic compatibility of multimedia equipment – Emission Requirements"
- CISPR 32:2010, "Electromagnetic compatibility of multimedia equipment – Emissions requirements"
- EN 55024:2010, "Information technology equipment – Immunity characteristics. Limits and method of measurement"
- CISPR 24:2010 +A1:2015, "Information technology equipment – Immunity characteristics. Limits and method of measurement."
- TCVN 7189:2009, "Information technology equipment – Radio disturbance characteristics – Limits and method of measurements"
- Korea: KN32/KN35: 2015, Multimedia Class A

Disclaimer

The information contained in this manual is subject to change without notice. Universal Audio, Inc. makes no warranties of any kind with regard to this manual, including, but not limited to, the implied warranties of merchantability and fitness for a particular purpose. Universal Audio, Inc. shall not be liable for errors contained herein or direct, indirect, special, incidental, or consequential damages in connection with the furnishing, performance, or use of this material.

End User License Agreement

Your rights to the Software are governed by the accompanying End User License Agreement, a copy of which can be found at: www.uaudio.com/eula

Trademarks

Universal Audio, the Universal Audio “diamond” logo, Apollo, Apollo Twin, Apollo 16, Unison technology, UAD, UAD Series, UAD-1, UAD-2, UAD-2 Satellite, Powered Plug-Ins, 1176LN, 1176SE, Teletronix, LA-2A, LA-3A, LA-610, LA-610MkII, 2-1176, 2-610, 6176, 710 Twin-Finity, 2192, 4-710d, Cambridge EQ, DreamVerb, Plate 140, Precision Limiter, RealVerb Pro, Precision Buss Compressor, Precision De-Esser, Precision Maximizer, and “Analog Ears | Digital Minds,” are among the trademarks, trade names, and service marks owned by UA that may appear on the Site, many of which are registered in the United States and other countries. This is not a comprehensive list of all UA trademarks. All UA trademarks inure to the benefit of UA. Other trademarks and trade names that may appear on the Site and which are not owned by UA are owned by the respective owners.

Copyright

Copyright ©2018 Universal Audio, Inc. All rights reserved.

This manual and any associated software, artwork, product designs, and design concepts are subject to copyright protection. No part of this document may be reproduced, in any form, without prior written permission of Universal Audio, Inc.

Technical Support

Universal Audio Knowledge Base

The UA Knowledge Base is your complete technical resource for configuring, operating, troubleshooting, and repairing UA products.

You can watch helpful support videos, search the Knowledge Base for answers, get updated technical information that may not be available elsewhere, and more.

[UA Knowledge Base](#)

YouTube Support Channel

The Universal Audio Support Channel at youtube.com includes helpful support videos for setting up and using UA products.

[UA YouTube Support Channel](#)

Universal Audio Community Forums

The unofficial UA discussion forums are a valuable resource for all Universal Audio product users. This website is independently owned and operated.

www.uadforum.com

Contact Universal Audio Support

To contact UA support staff for technical or repair assistance, please visit:

help.uaudio.com

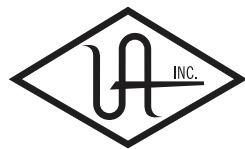

UNIVERSAL AUDIO