

TIBO - 533WW

500 - LED 75 W



- **Type:** Profile spot
- **Source:** LED 75 W
- **PSU:** Electronic - DMX
- **Optics:** 30° to 45° zoom
15° to 35° configuration possible
- **Colour temperature:** 3000 K

Profile spot

Brighter and Smaller

TIBO is a compact and lightweight LED profile. It combines all the features and functions of a standard Robert Juliat lantern profile with an LED lightsource, ensuring a low power consumption whilst maintaining projection quality. It features an outstanding unique optical design that allows two different zoom ranges (15°-35° and 30°-45°) in one single unit. TIBO fits aesthetically into any application, from architectural to event applications as well as traditional entertainment lighting.

Features

- **Shutter gate:** 4 shutters. Remove shutters for easy maintenance or tuck fully inside gate for secure transport
- **User-friendly shutter-lock system:** Secures shutters' setting in any circumstances
- **Universal gobo holder:** M-size plastic, glass and metal gobos
- **Continuous 360° rotation of the fixture:** Adjustment of the projected image is always possible
- **Dimming:** No clipping or cut-out below 20% - high quality smoothing
- **Control:** 8 or 16 bits dimming and strobe function
- **Parameters:** Adjustable curves and response thru 4-button display with automatic light switch-off
- **Tilt reference on hanging yoke:** Index for rapid re-positioning

Optical

- **Very long-life lamp source:** 50 000 hours - Lumen maintenance of greater than 70% after 50 000 hours
- **Coated double condenser optical system:** for exceptional optical quality
- **Variable zoom optics:** Sharp focus at every beam angle. Independent control of image size and focus. Focus handles on both sides
- **Two different zoom ranges in one single unit:** 30/45° or 15/35° by adding/removing one lens - save on material costs and storage of separate lens tubes

Construction

- **Made in France :** Fully manufactured on the premises retaining complete control over all aspects of quality
- **Connectors:** NeutriK® powerCON TRUE1 in and out connectors for daisy chaining
- **Separate electronic flicker-free PSU:** Can be separate or on yoke
- **Silent-running cooling fans:** Ideal for TV studios and opera houses
- **Bodywork:** Die cast aluminium housing
- **Captive knobs and handles:** Additional security when working at height or in transit
- **Spare parts and accessories:** Uniform across the tungsten or LED TIBO range, reducing running costs
- **Easy access to lens tube:** Easy cleaning of zoom lenses

Picture:533

DSEN174_533WW - 23/10/2012

Robert Juliat reserves the right to change or alter any of the items detailed on this page, to increase or improve manufacturing techniques without prior notice.

Robert Juliat S.A.S., 32 rue de Beaumont, 60530 Fresnoy-en-Thelle - France
Téléphone : +33 (0)3 44 26 51 89 - fax : +33 (0)3 44 26 90 79 - info@robertjuliat.fr
www.robertjuliat.com



ROBERT JULIAT

Admissible lamps



Lamp type: LED
Power: 75W

Reference	Power	Lumen output	Colour temperature	Lamp life	IRC
Tibo 75W WW (Robert Juliat)	75 W	5 400 lm	3 000 K	50 000 h	82

Optics

Characteristics

- **Type:** Zoom
- **Beam range:** 30° to 45°
15° to 35° configuration possible
- **Focal length:** 68 - 105 mm

Gel filter

- **Shape:** Square
- **Standard size:** 138x138 mm (5.4x5.4 in)

Gobo

- **Size:** M
- **Material:** Metal
Glass
Plastic

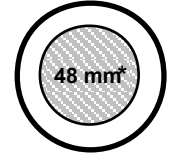

66 mm

*Maximum image size

Photometrics

with Tibo 75W WW (Robert Juliat) lamp

• Optics @ 30°

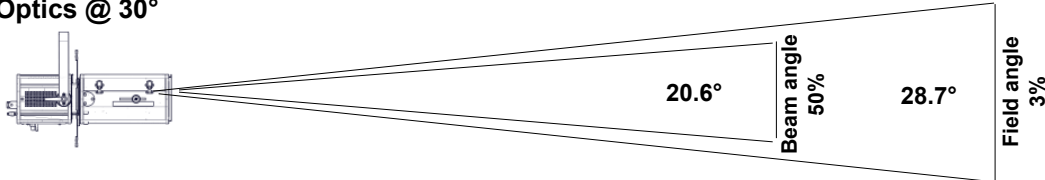

Beam intensity
29 700 cd

Field lumens
3 320 lm

Efficacy
44 lm/W

CCT
3 330 K

Distance	3 m	5 m	7 m	10 m	12 m	15 m
Field diameter	1.6 m	2.7 m	3.8 m	5.4 m	6.4 m	8 m
Illumination	3 350 lux	1 200 lux	610 lux	300 lux	210 lux	140 lux
Distance	1 ft	10 ft	20 ft	30 ft	30 ft	40 ft
Field diameter	0.5 ft	5.4 ft	10.7 ft	16.1 ft	16.1 ft	21.4 ft
Illumination	30 000 fc	300 fc	75 fc	34 fc	34 fc	19 fc

• Optics @ 45°

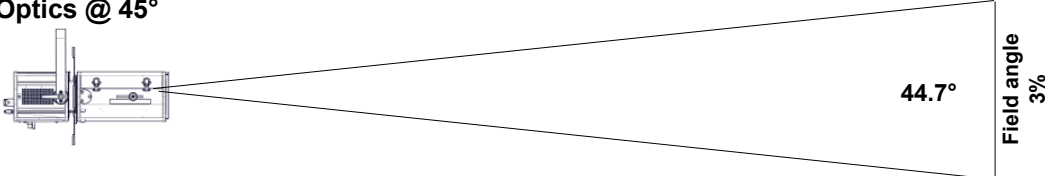

Beam intensity
14 600 cd

CCT
3 320 K

Distance	3 m	5 m	7 m	10 m	12 m	15 m
Field diameter	2.5 m	4.1 m	5.8 m	8.3 m	9.9 m	12.4 m
Illumination	1 650 lux	590 lux	300 lux	150 lux	110 lux	65 lux
Distance	1 ft	10 ft	20 ft	30 ft	30 ft	40 ft
Field diameter	0.8 ft	8.3 ft	16.6 ft	24.9 ft	24.9 ft	33.1 ft
Illumination	15 000 fc	150 fc	37 fc	17 fc	17 fc	10 fc

Remote control

• **Data protocol:** USITT DMX512-A

• **Data IN connector:** 5 pins XLR male

• **Data OUT connector:** 5 pins XLR female



• **DMX chart:**

	Mode 1	Mode 2	Mode 3	Mode 4
Channels	Dimmer	Dimmer Strobe	Dimmer Dimmer fine	Dimmer Dimmer fine Strobe

Dimensions, weight and volumes

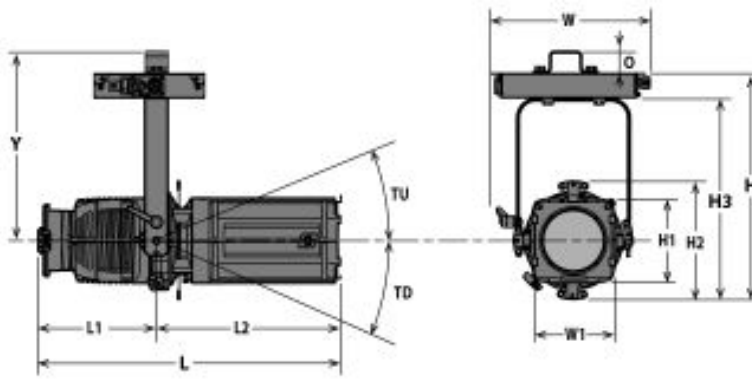

Weight: 10.4 kg (22.9 lbs)

Height	Length	Width	Yoke	Tilt	Option
H= 397 mm (15.6 in)	L= 526 mm (20.7 in)	W= 289 mm (11.4 in)	Y= 252 mm (9.9 in)	TU= 55°	O= 35 mm (1,4 in)
H1= 150 mm (5.9 in)	L1= 200 mm (7.9 in)	W1= 150 mm (5.9 in)		TD= 90°	
H2= 174 mm (6.9 in)	L2= 326 mm (12.8 in)				
H3= 339 mm (13.3 in)					

Shipping

• **Weight :** 12 kg (26.4 lbs)

• **Volume :** .04 m³ (1.38 ft³)



Width: W= 289 mm (11.4 in)

Height: H= 58 mm (2.3 in)

Length: L= 195 mm (7.7 in)

Weight: 2.3 Kg (5.1 lbs)

Installation

• **Minimum distance to illuminated surface:** 0.3 m (1.0 ft)

• **Operating position:**

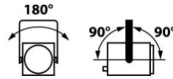

Approvals



Construction

- **Housing:** Die cast aluminium
- **Colour:** Black
- **Cooling:** Low noise variable fan
- **Maximum ambient temperature (Ta):** 40°C (104°F)
- **Maximum case temperature (Tc) :** 60°C (140°F)
- **Total heat dissipation:** 324 BTU/h
- **Protection rating:** 20

- **PSU housing:** Steel sheet - Aluminium
- **PSU colour:** Black
- **PSU cooling:** Convection cooling
- **PSU maximum ambient temperature (Ta):** 40°C (104°F)
- **PSU maximum case temperature (Tc) :** 50°C (122°F)

Electrical compatibility

- 220/230 V - 50 Hz
- 220 V - 60 Hz
- 245 V - 50 Hz
- 100 V - 50 Hz
- 110/120 V - 60 Hz
- 100 V - 60 Hz
- 208 V - 60 Hz
- Selector: automatic detection

Power cable



- **Cable:** H07RNF 3G1.5
- **Length:** 3 m (9,8 ft)
- **Connectors:**
In: CEE 7/7 (2P+E NF/Schuko)
Out: Neutrik powerCON TRUE1

Power consumption

Voltage	Frequency	Current	Power	Power factor
230 V	50 Hz	0.42 A	95 W	>0.98
120 V	60 Hz	0.8 A	95 W	>0.98
100 V	60 Hz	0.95 A	95 W	>0.94

Power Supply Unit





- **PSU:** On yoke - Electronic PSU - Flicker free with PFC
- **Lighting unit/PSU cable:** Not removable - length: 1 m (3,3 ft)
Type: 3M ref. 3696
- **Maximum distance between lighting unit and PSU:** 5 m (16 ft)
- **Control:** Local / DMX
- **Protection:** Mains: 4A 1P1D breaker - UL /
- **Power thru:** Neutrik powerCON TRUE1 - Maximum of 35 units (230 V) / 20 units (110 V)





Model

533WW	LED 75 W Profile spot - 533WW Tibo - 3000K - 30/45°
--------------	---

Options

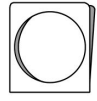
PCP1716A	16A blue 2P+E 6h IEC60309 power connector	
T-RAL9010	White housing (RAL 9010)	
W-DMX	W-DMX wireless DMX	

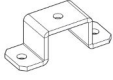
Accessories

PF100M	135x135mm metal filter holder 1 included	
D4	Shutter (M size) 4 included	
OmegaT	PSU 1 included	
SGUT	Universal "M" size gobo-holder (metal, glass, frosted glass)	
872	Doughty Twenty clamp with M10 screw/nut for Ø48 to 51 mm pipes - SWL: 20Kg - TÜV approved	
878	Hook clamps 25x6 mm with 23 mm screw for Ø35 to 50 mm pipes (15Kg max)	
CS2	Safety cable Ø3 mm L= 600 mm(breaking point:75Kg)	